

6+ | **3** | **0,7m** | **1 = 0m 2 = 0m 3 = 0m**

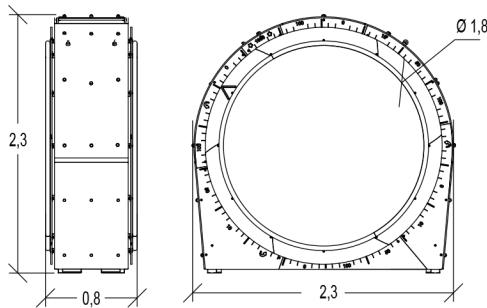

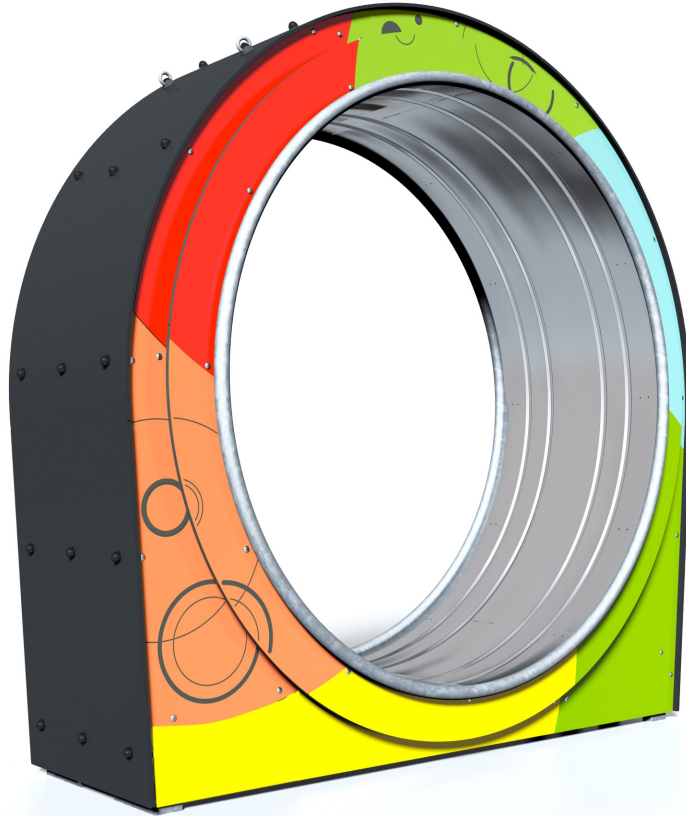



Motor disability

Sensorial disabilities

Learning disabilities

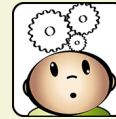

Play value : 5

meeting 
balancing 
rotating 
visual stimulation 
thinking 

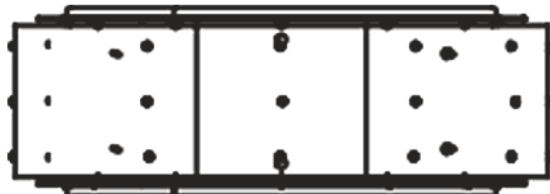







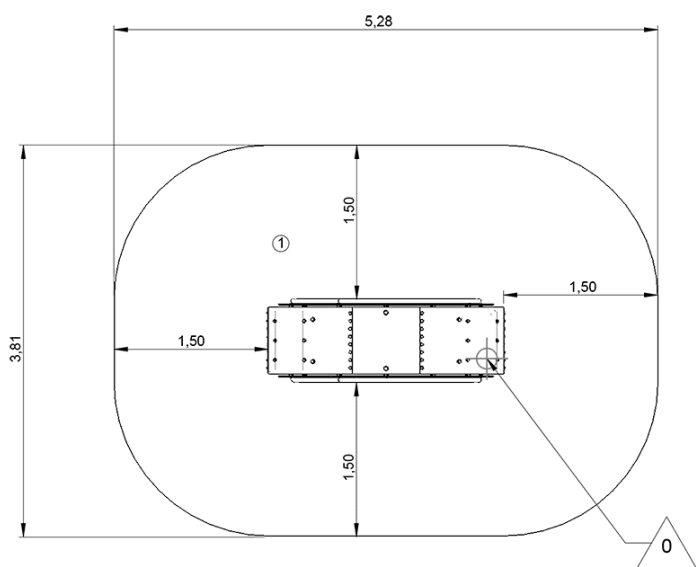



Installation of equipment

Impact area =

-  Impact area
-  Free space

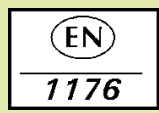

	
1	0,7m
	18,5m ²

								
2	04h00	0.5m ³	18.5m ²	400kg	361kg			0000-00-00