



5+



11



2,4m



1 = 3,5m 2 = 2,4m 3 = 2,4m

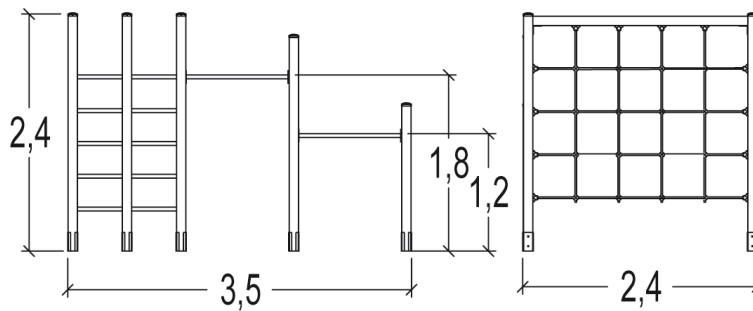
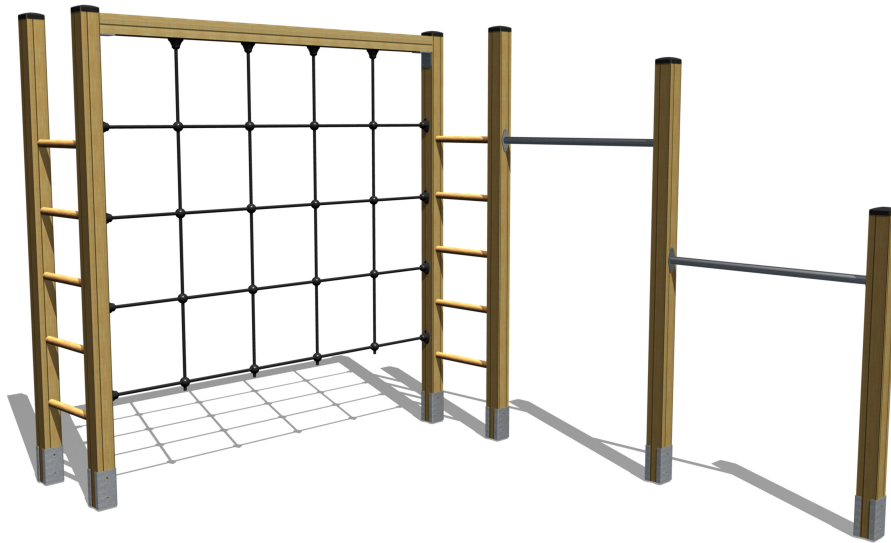

Play value : 2

climbing



x1

getting across



x1

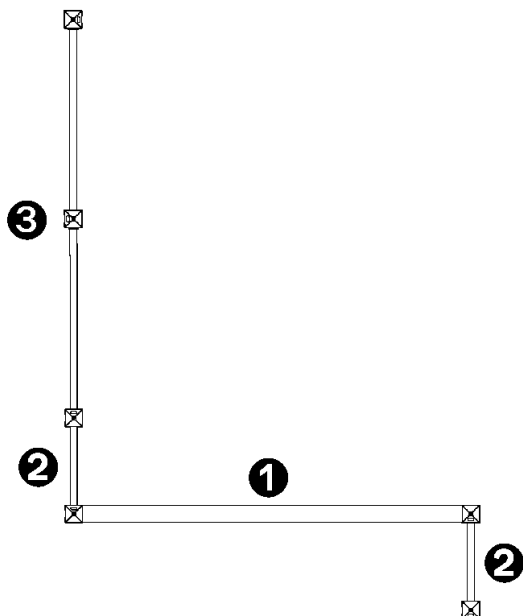



- ❶ Climbing net
- ❷ Step ladder
- ❸ Horizontal bar HT: 1.2m et 1.8m

Installation of equipment

Impact area =

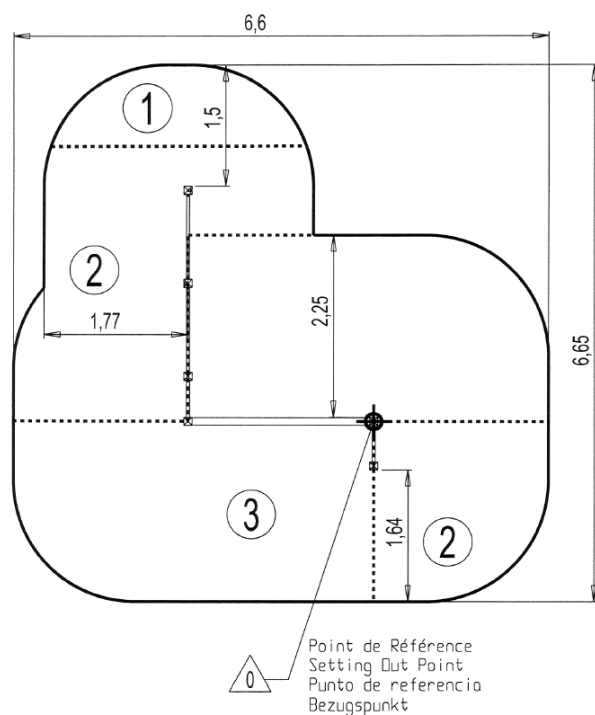
-  Impact area
-  Free space



		
1	1,20m	2,5m ²
2	1,8m	13m ²
3	2,4m	19,5m ²



2



03h00



0.2m³



35m²



142kg



27kg

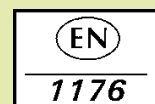

Proludic

2013-08-27