



6+

14

2,9m

1 = 5,72m 2 = 3,08m 3 = 3,03m

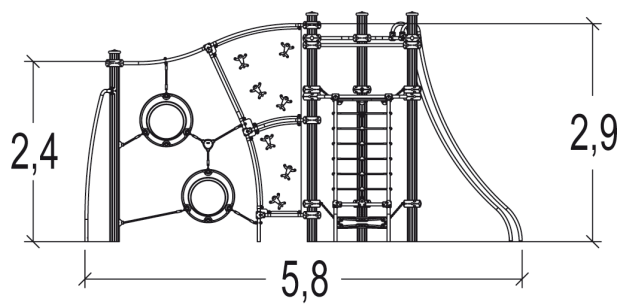
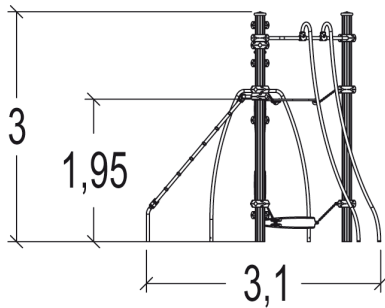
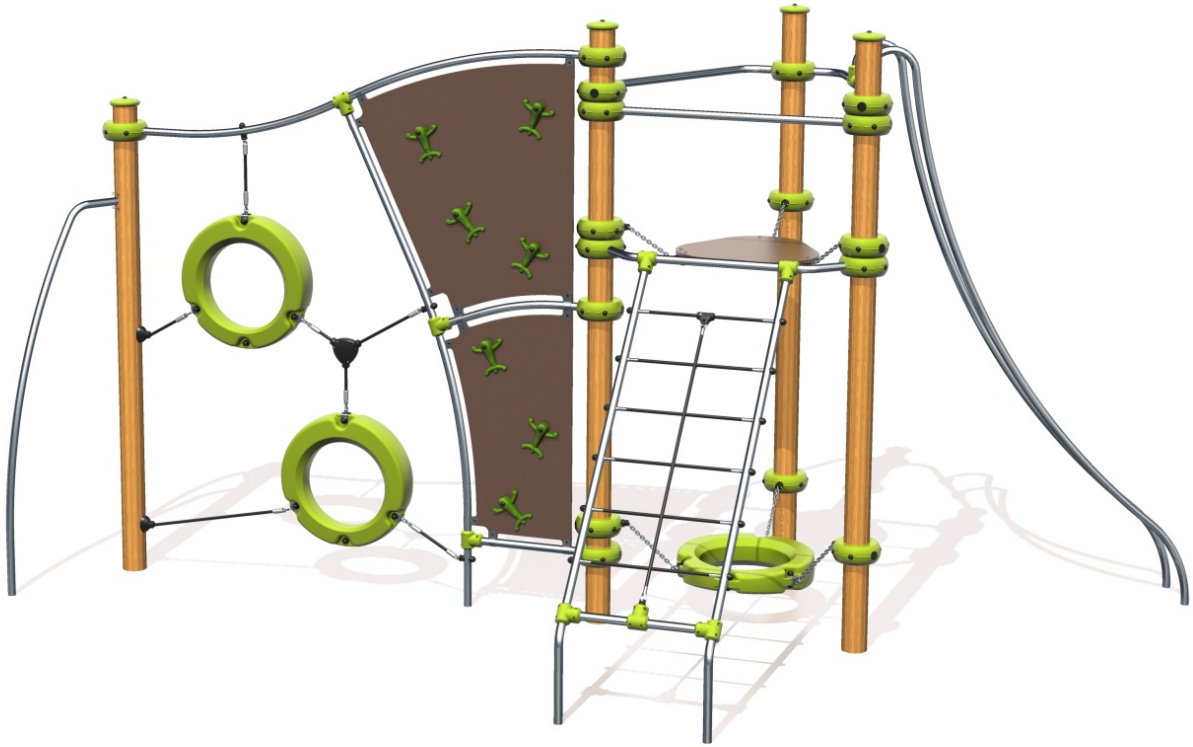

Play value : 9

climbing



x1

sliding



x1

meeting



x1

resting



x1

swinging



x1

balancing



x1

climbing



x2

getting across



x1

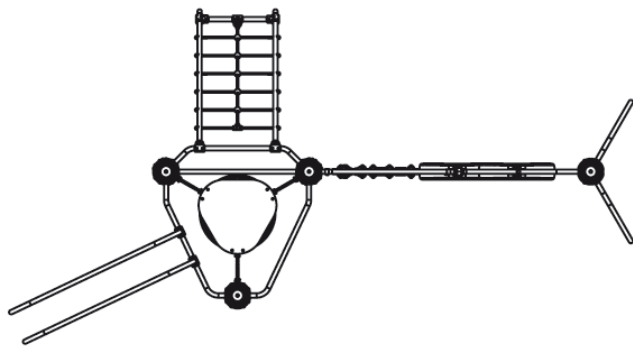

- ① Delta tower
- ② Delta Incline net
- ③ Speed slide
- ④ Horizontal buoy
- ⑤ Look-out

Installation of equipment

Impact area =

- Impact area
- Free space

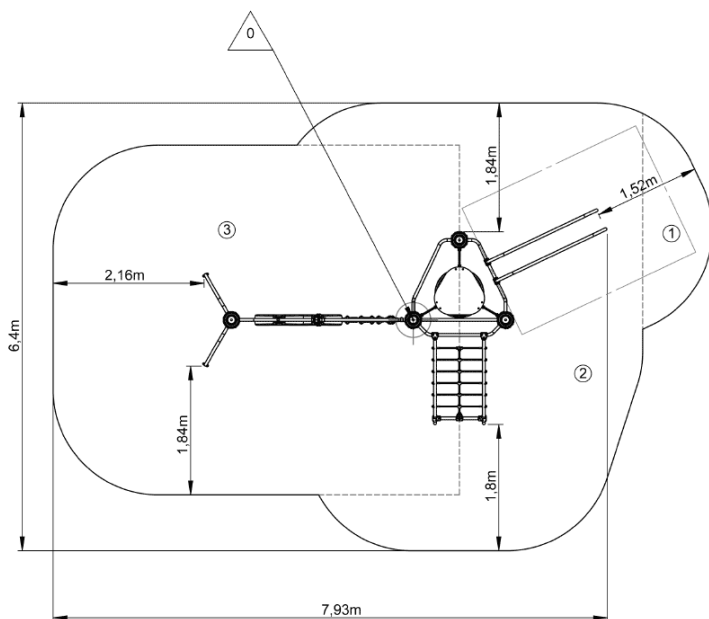

1	0,6m	2m ²
2	1,95m	18m ²
3	2,97m	28m ²



2



06h00



0.6m³



48m²



281kg



20kg

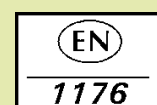

Proludic

0000-00-00