



1+



1



0,6m



1 = 0,5m 2 = 0,48m 3 = 0,68m



Motor disability

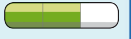

Sensorial disabilities



Learning disabilities

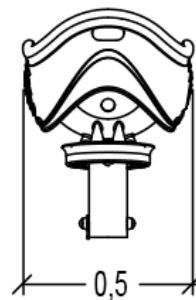
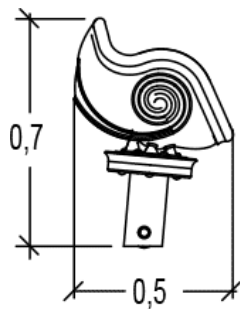
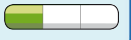

Play value : 4

meeting



balancing



resting



rotating



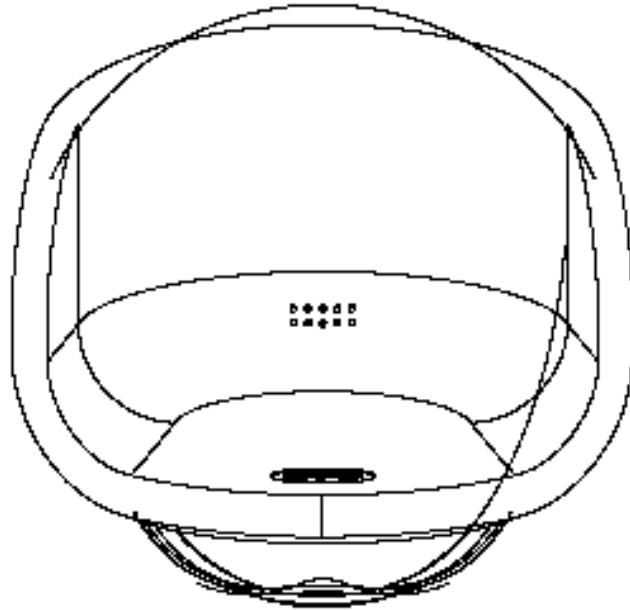







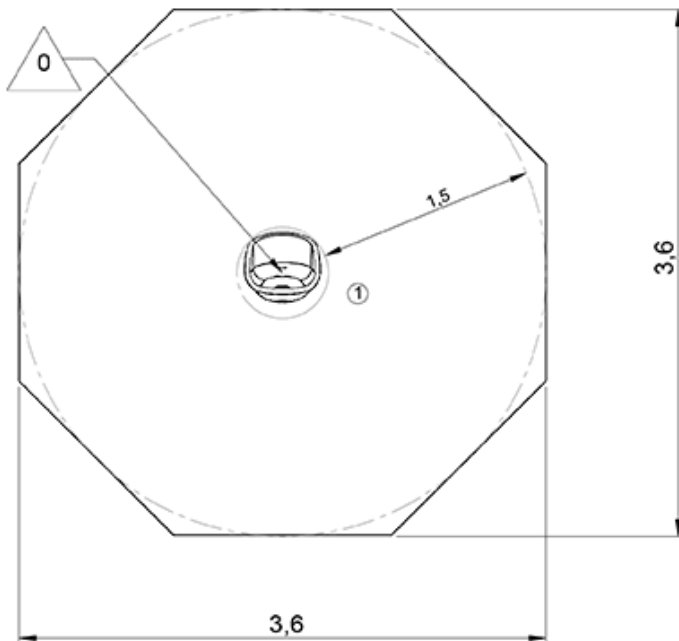



## Installation of equipment

Impact area =

-  Impact area
-  Free space

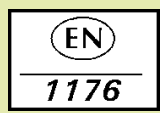

		
1	0,6m	11m <sup>2</sup>

							
2	01h45	0.04m <sup>3</sup>	11m <sup>2</sup>	25kg	25kg		0000-00-00