



2+



1



0,6m



1 = 0,91m 2 = 0,3m 3 = 0,87m



Motor disability

Sensorial disabilities

Learning disabilities

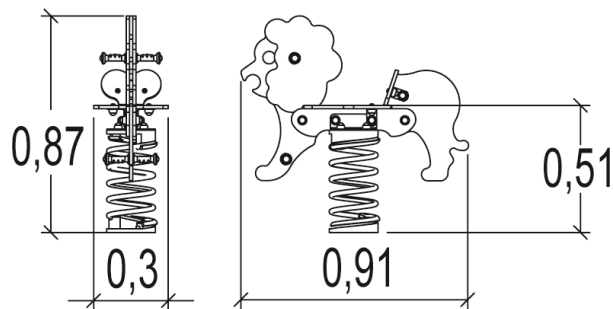
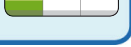
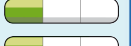
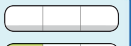

Play value : 2

swinging



balancing



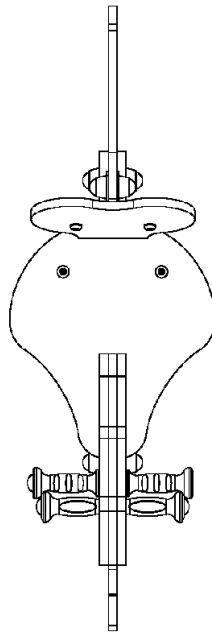



## Installation of equipment

Impact area =

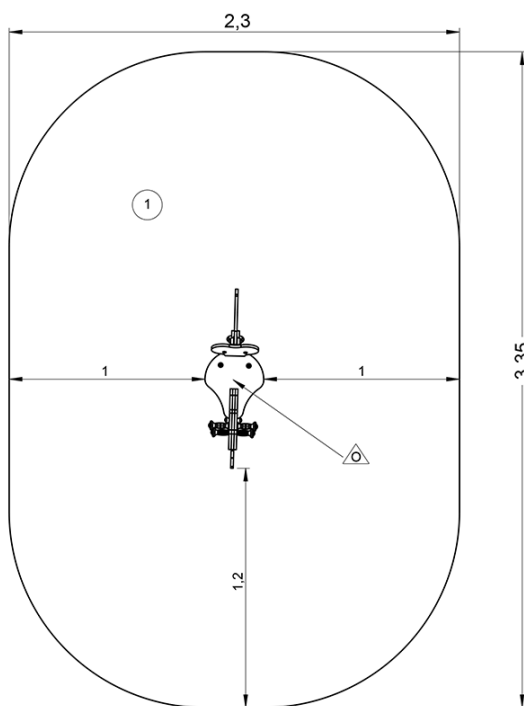
-  Impact area
-  Free space



		
1	0,6m	7m <sup>2</sup>



1



01h00



0m<sup>3</sup>



7m<sup>2</sup>



30kg



10kg

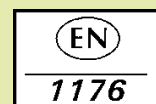

*Proludic*

2003-10-15