



2-8



1



0,6m



1 = 0,55m 2 = 0,4m 3 = 0,96m



Motor disability

Sensorial disabilities

Learning disabilities

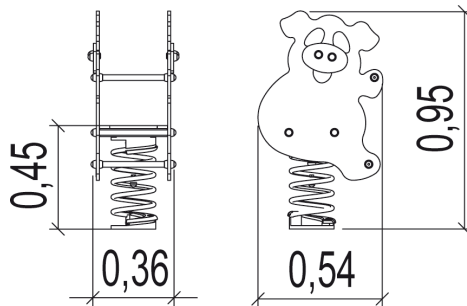
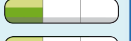
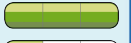

Play value : 2

swinging



balancing



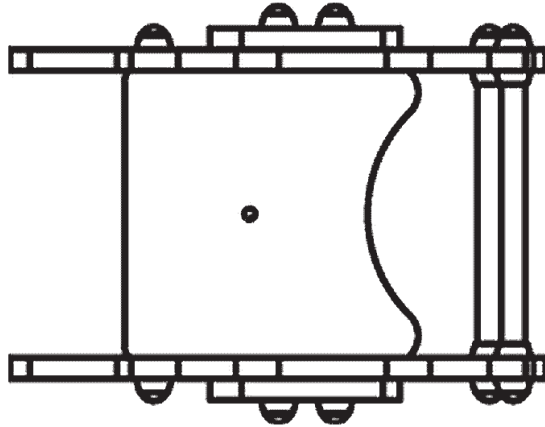







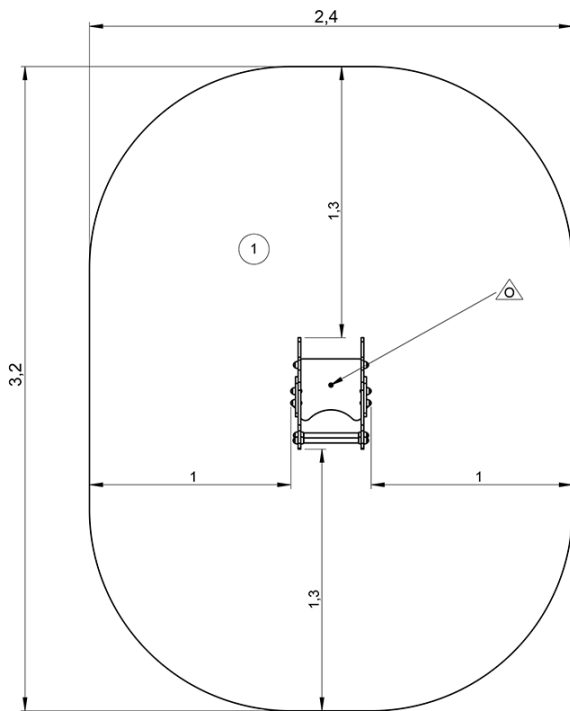



## Installation of equipment

Impact area =

-  Impact area
-  Free space

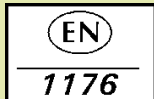

		
1	0,46m	6,5m <sup>2</sup>

							
1	01h00	0m <sup>3</sup>	7m <sup>2</sup>	32kg	11kg		2014-04-30