



2-8



1



0,6m



1 = 0,74m 2 = 0,4m 3 = 1m



Motor disability

Sensorial disabilities

Learning disabilities

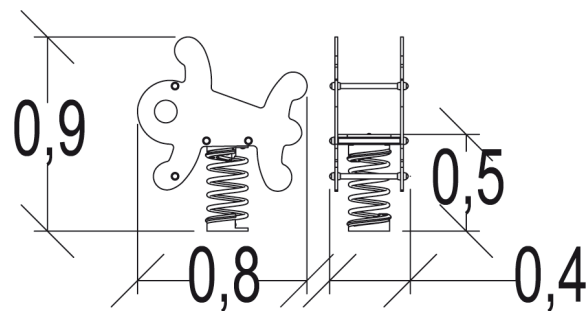
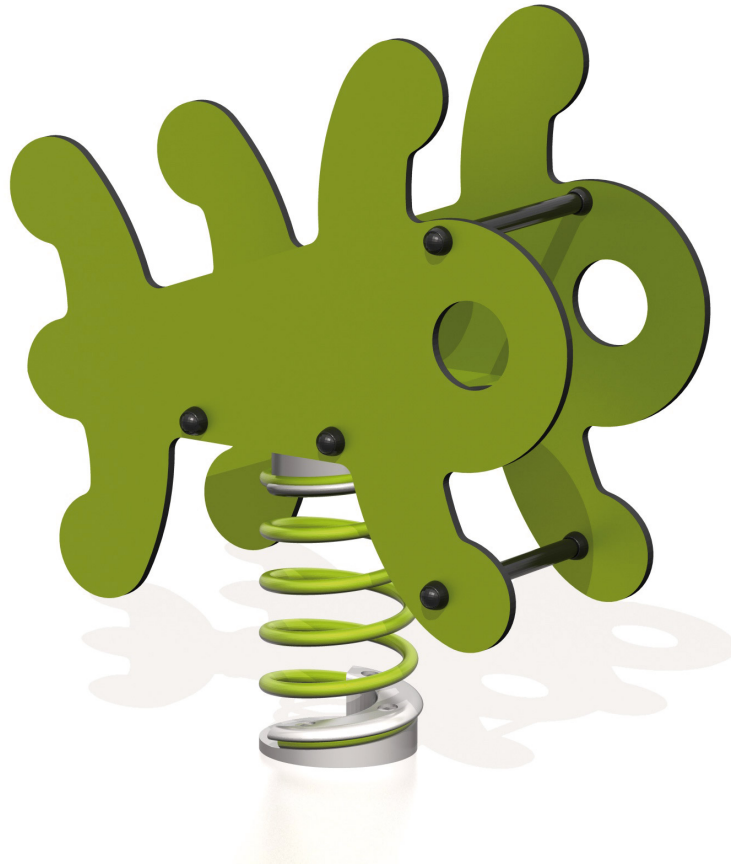
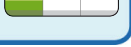
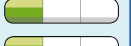
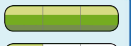

Play value :

2

balancing



swinging



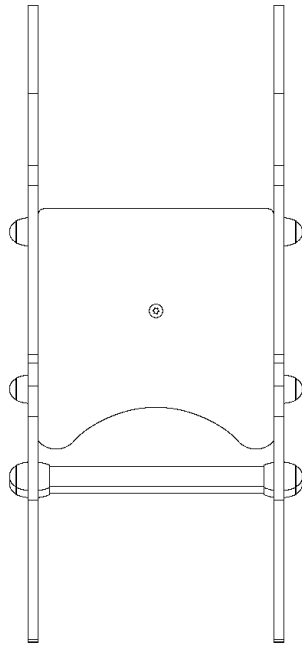







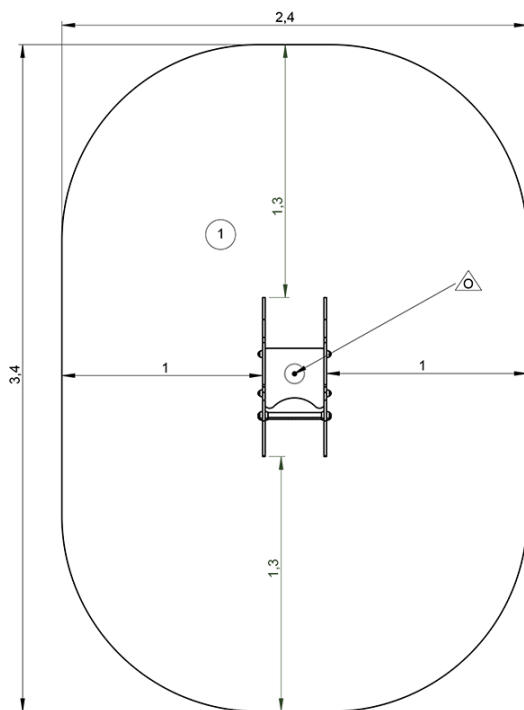

## Installation of equipment

Impact area =

-  Impact area
-  Free space



	
1	0,6m
	7m <sup>2</sup>

					
1	01h00	0m <sup>3</sup>	7m <sup>2</sup>	32kg	11kg

