



2-8



1



0,6m



1 = 0,74m 2 = 0,33m 3 = 0,84m



Motor disability

Sensorial disabilities

Learning disabilities

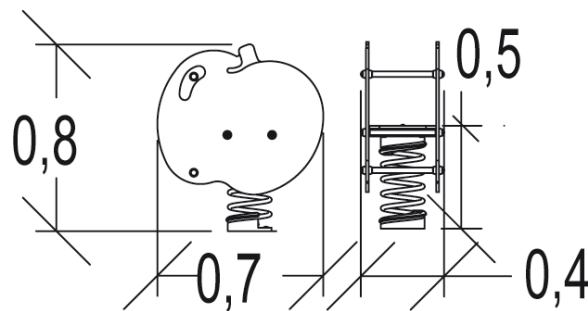
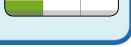
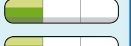
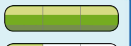

Play value : 2

balancing



rotating



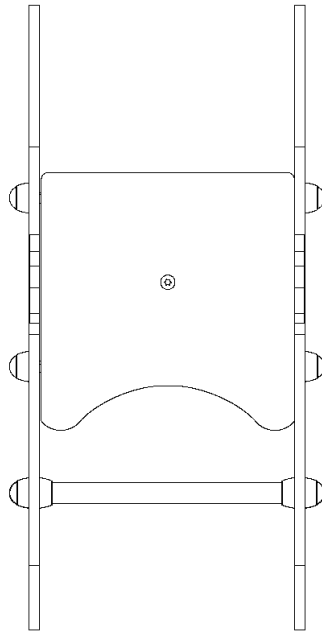







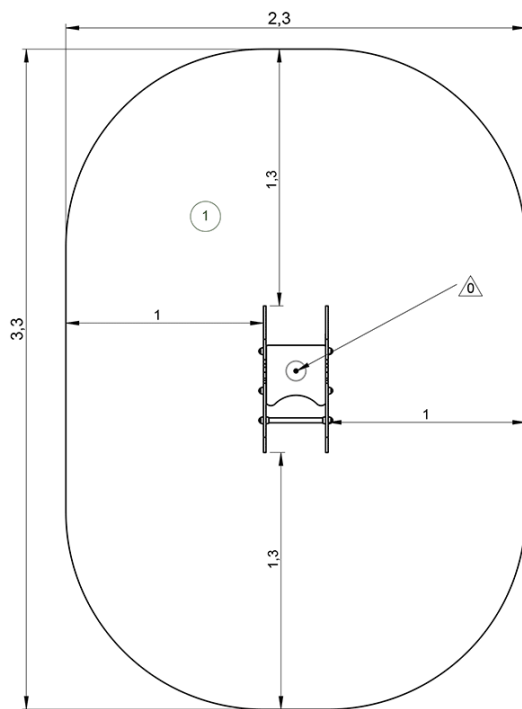

## Installation of equipment

Impact area =

-  Impact area
-  Free space



		
1	0,6m	7m <sup>2</sup>

					
1	01h00	0m <sup>3</sup>	7m <sup>2</sup>	36kg	11kg

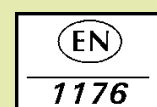

*Proludic*

2016-01-08