



2+



4



0,75m



1 = 2,3m 2 = 0,29m 3 = 0,72m



Motor disability

Sensorial disabilities

Learning disabilities

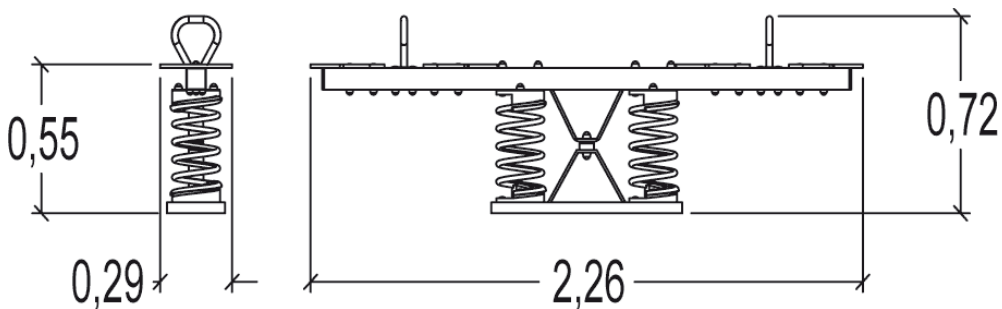
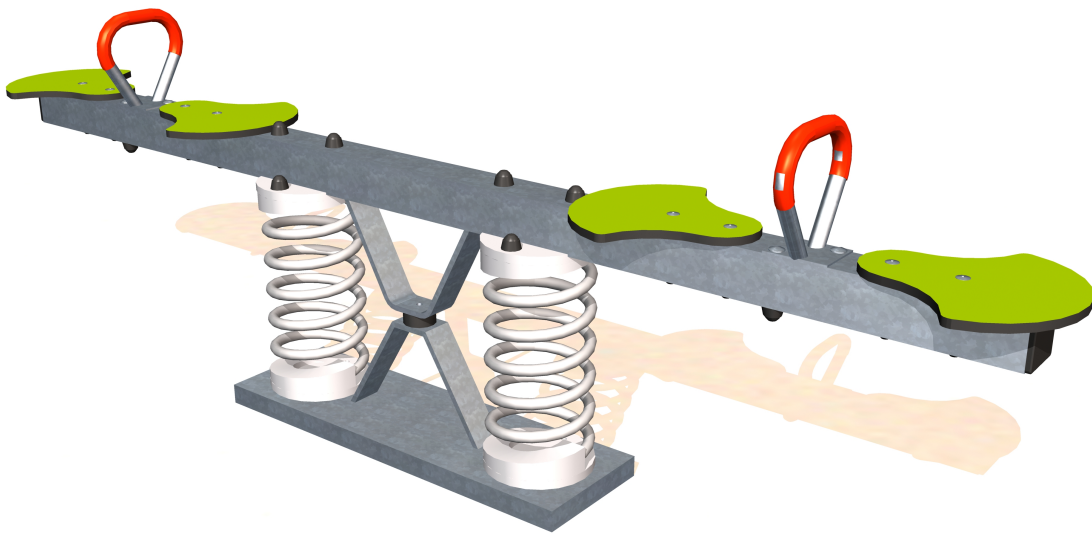
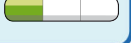
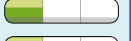
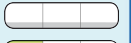

Play value :

3

swinging



balancing



meeting



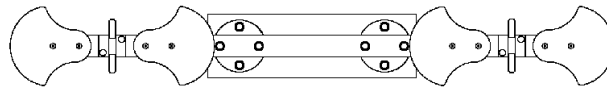

Installation of equipment

Impact area =

- Impact area
- Free space

1	0,75m
	10m ²

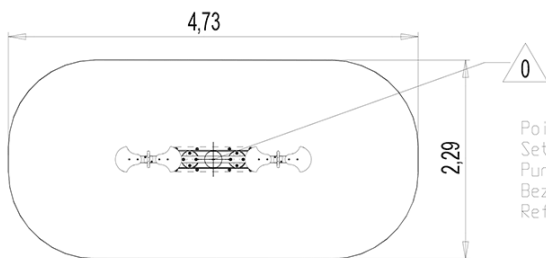

Point de Référence
Setting Out Point
Punto de referencia
Bezugspunkt
Referentiepunt



2



00h00



0m³



10m²



65kg



45kg



Proludic

0000-00-00