



2+



2



0,6m



1 = 1,1m 2 = 0,38m 3 = 0,9m



Motor disability

Sensorial disabilities

Learning disabilities

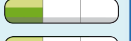
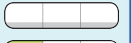

Play value : 2

swinging



balancing



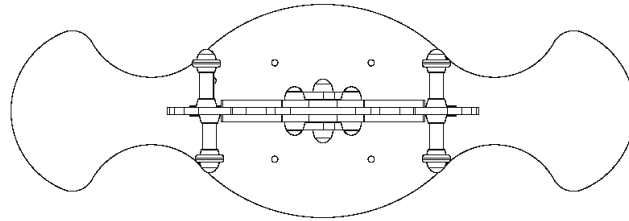



## Installation of equipment

Impact area =

-  Impact area
-  Free space

		
1	0,6m	7m <sup>2</sup>

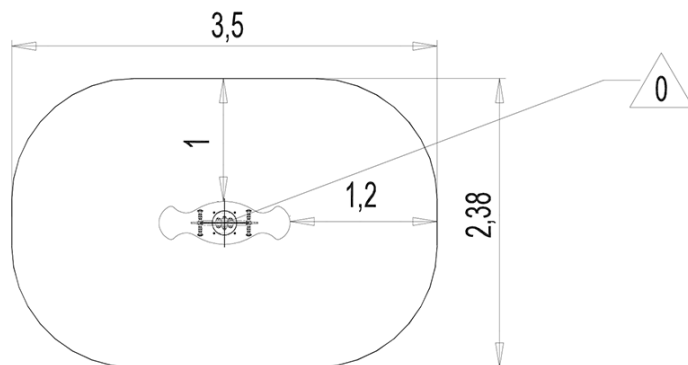

1



01h00



0m<sup>3</sup>



7m<sup>2</sup>



33kg



11kg

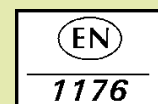

*Proludic*

2012-11-07