



2+



10



0,6m



1 = 2,3m 2 = 1,4m 3 = 1,9m



Motor disability

Sensorial disabilities

Learning disabilities

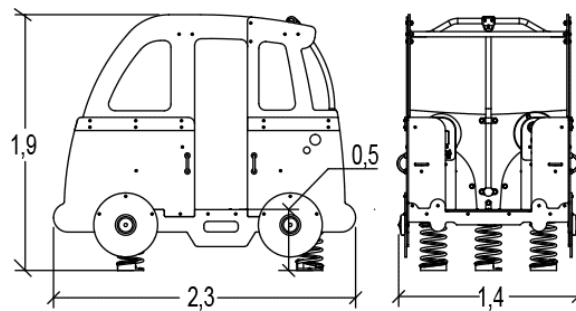
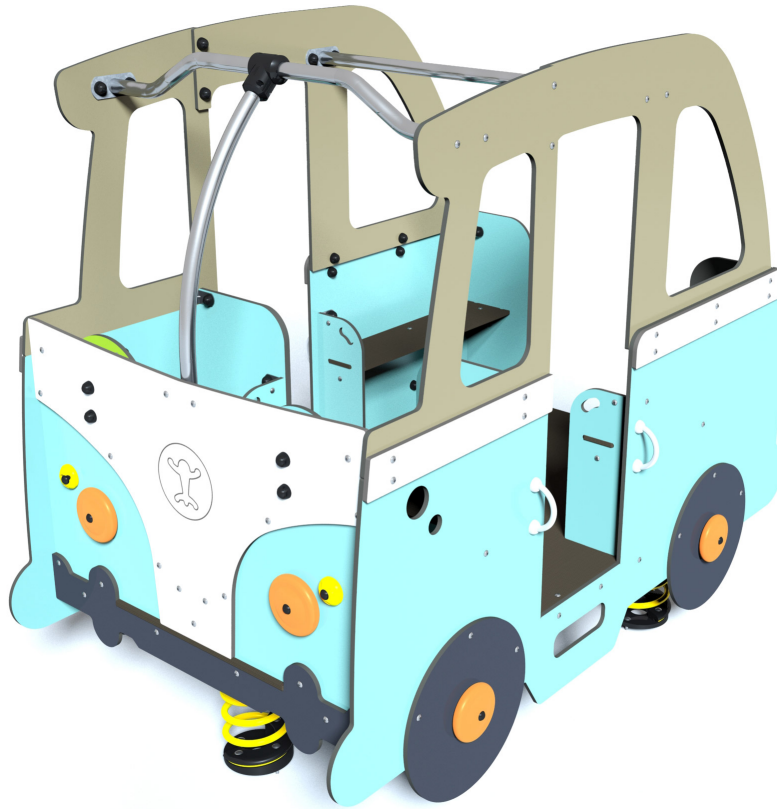
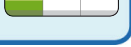
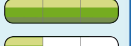
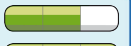

Play value :

7

resting



meeting



role play



balancing



thinking



handling



tactile stimulation



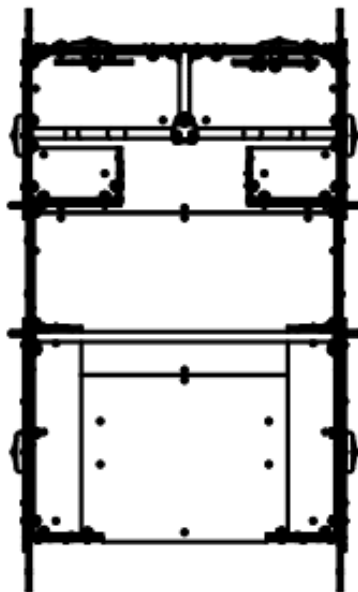



Installation of equipment

Impact area =

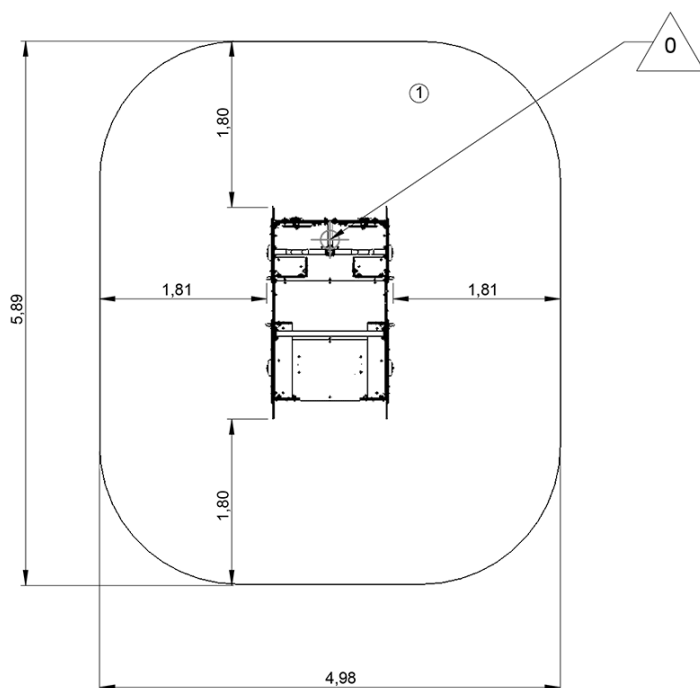
 Impact area
 Free space



		
1	0,6m	27,5m ²



2



05h00



0m³



27.5m²



313kg



13kg

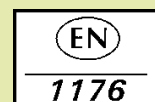

Proludic

0000-00-00