



3+



30



2,7m



1 = 10,7m 2 = 6,8m 3 = 3,6m



Motor disability

Sensorial disabilities

Learning disabilities

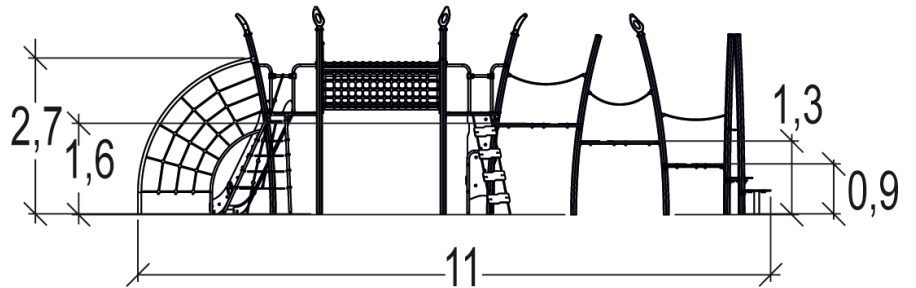
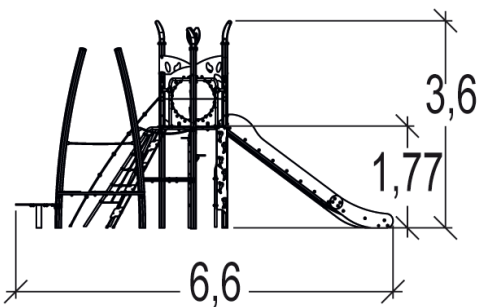

Play value : 12

climbing



x1

sliding



x1

meeting



x1

crawling



x1

balancing



x3

climbing



x4

getting across



x1

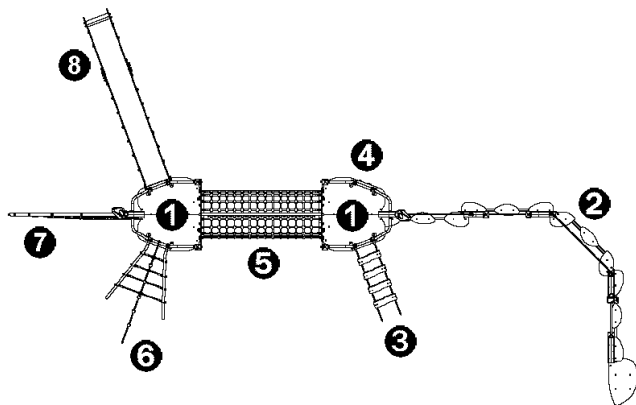

- ① Platform with no roof, Ht: 1,77m
- ② Pathway
- ③ Net ladder
- ④ Climbing wall
- ⑤ Net tunnel
- ⑥ Tilted net Ht: 1.77m
- ⑦ Leaf net
- ⑧ Slide Ht : 1.77m

Installation of equipment

Impact area =

- Impact area
- Free space

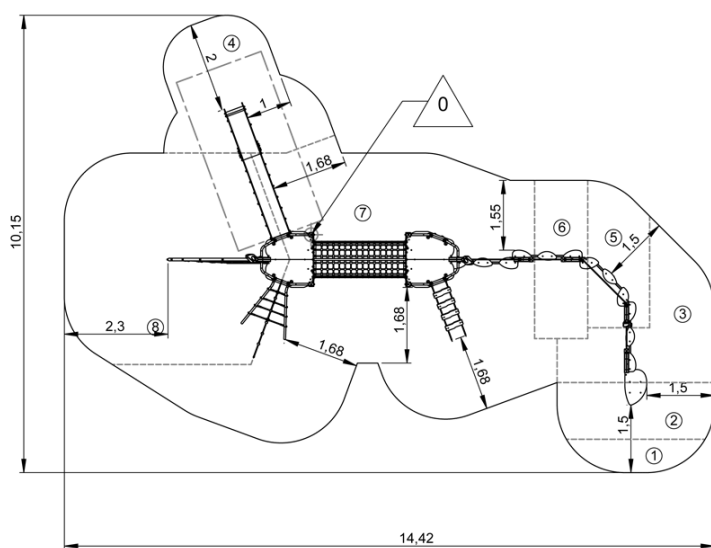

1	0,6m	2m ²
2	0,66m	5m ²
3	0,88m	6,5m ²
4	1m	8,5m ²
5	1,18m	4,5m ²
6	1,57m	9,5m ²
7	1,77m	36m ²
8	2,7m	20,5m ²



2



20h00



0.6m³



86.5m²



689kg



44kg

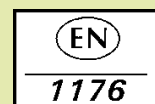

Proludic

0000-00-00