



2+

4

1m00

1 = 4m37 2 = 1m75 3 = 2m60

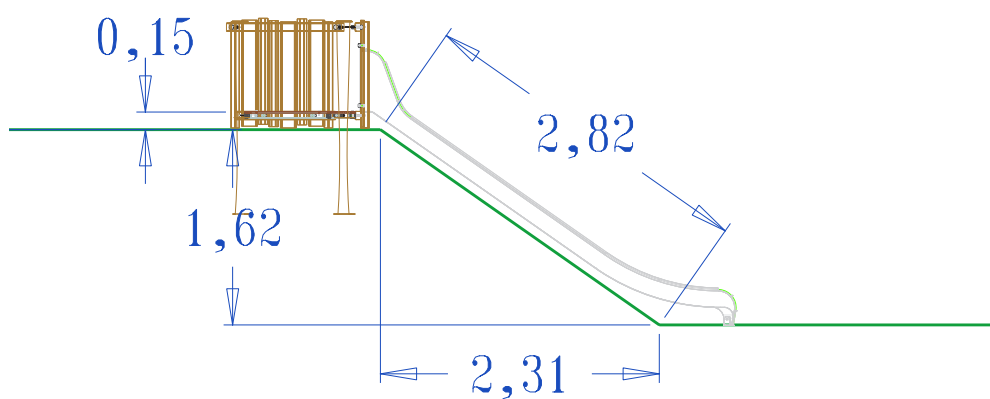
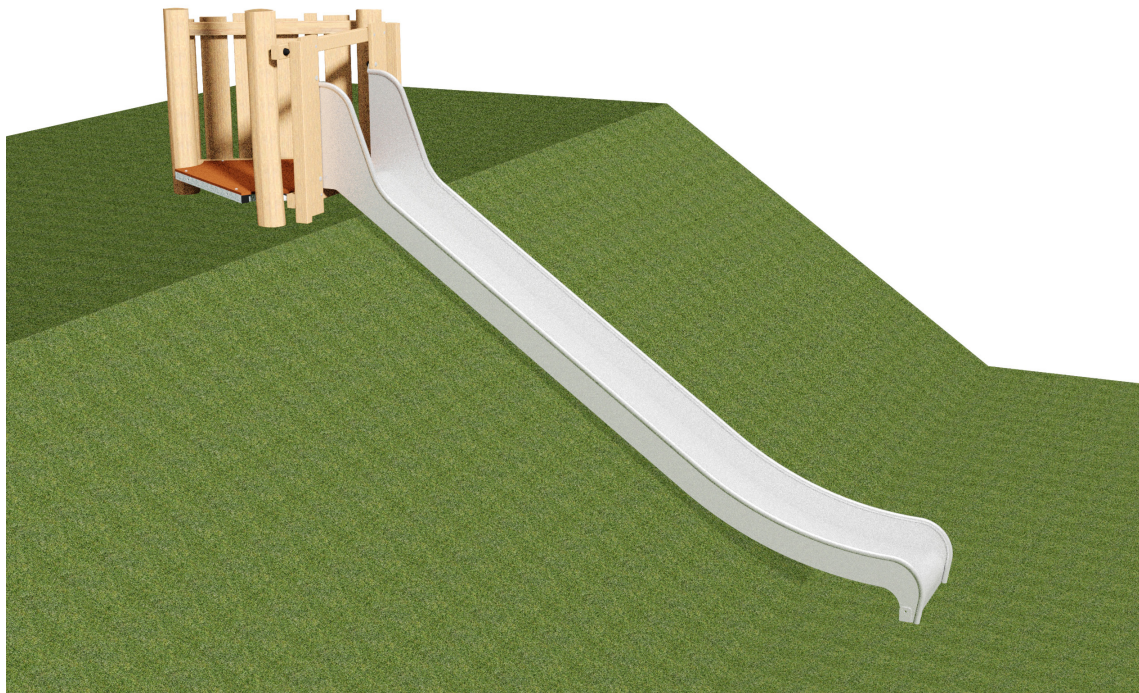

Fonctions ludiques

se rencontrer /fabuler

Glisser



X1

X1

Nombre d'éléments ludiques : 2

Accessibilité



Handicap moteur

Handicap sensoriel

Handicap mental

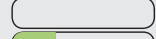

FT-BrD-10/07/2017

Proludic

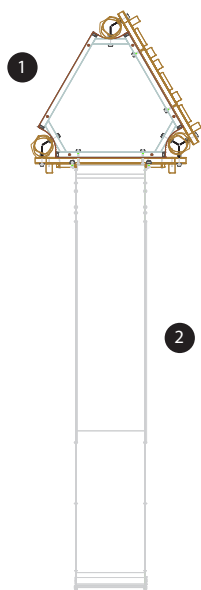



- ① Plate forme Ht. 0m15
- ② Toboggan Inox Ht. 1m77

Installation de l'équipement

Zone d'impact : Surface de sol minimale requise d'après la norme EN 1176-1

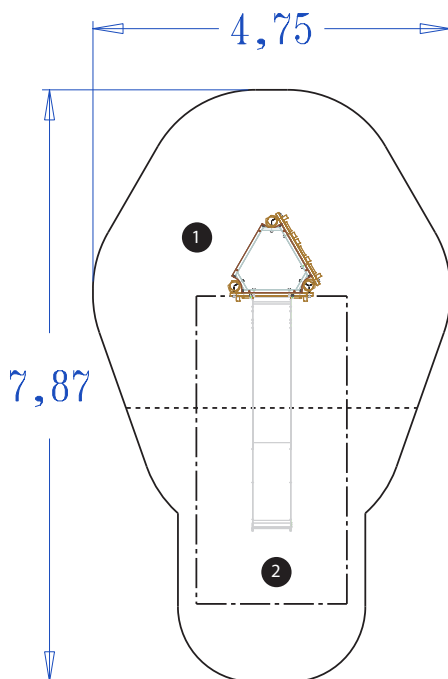
- Zone d'impact
- - - - - Espace libre



		
1	0,60 m	16,5 m ²
2	1,00 m	10 m ²