

 3+
 6
 0,6m

 1 = 4,04m
 2 = 1,14m
 3 = 1,19m



Motor inclusion
 Sensory inclusion
 Mental inclusion

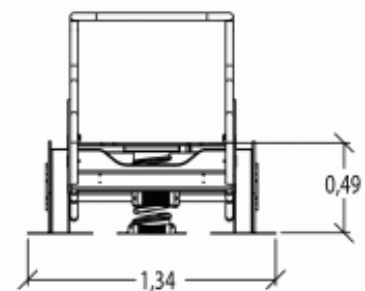
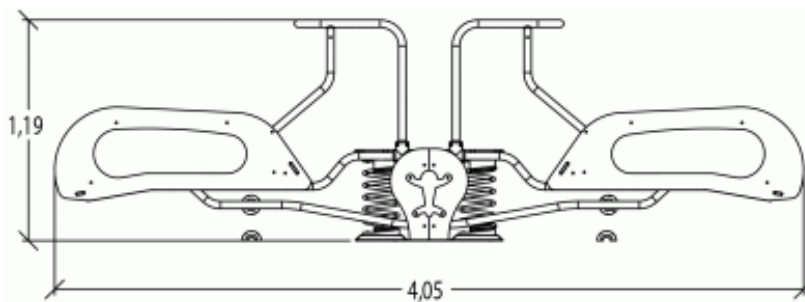
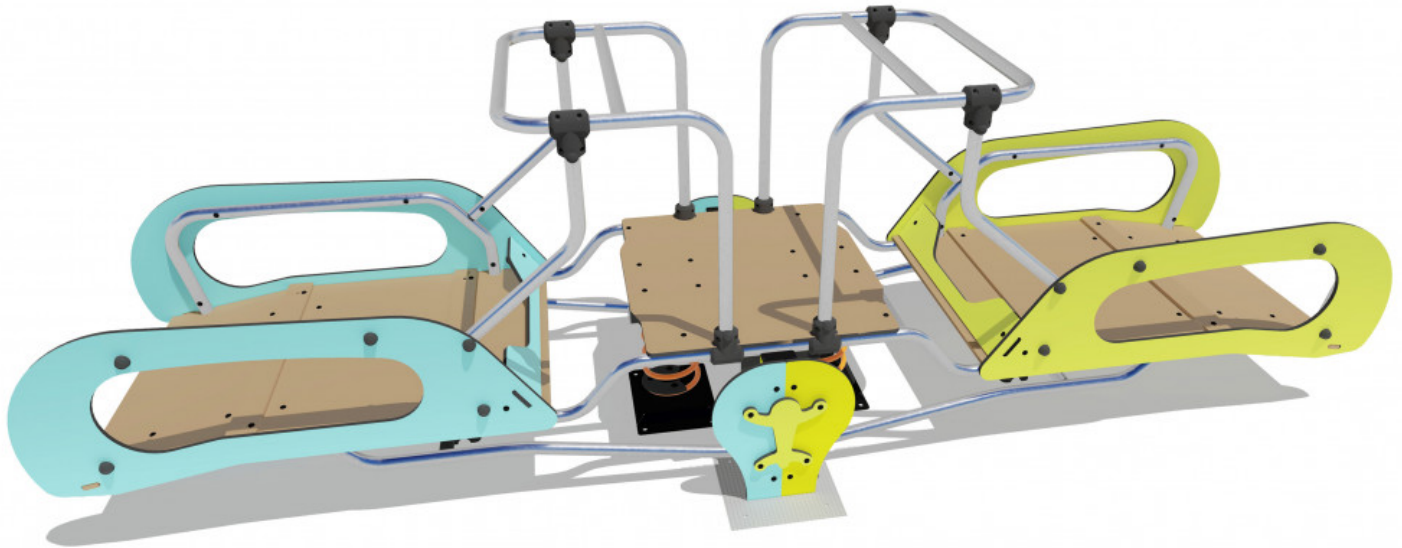

Play value : 5

- | | | | | |
|---|---|---|---|---|
| role play | meeting | resting | swinging | balancing |
|  |  |  |  |  |
| x1 | x1 | x1 | x1 | x1 |

Components

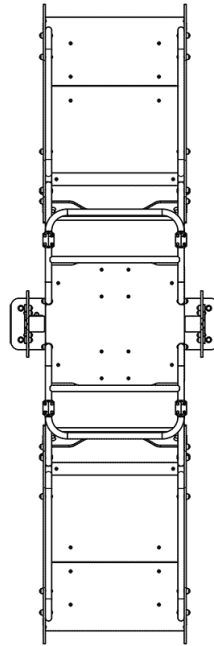

Installation of equipment

Impact area =

— Impact area
- - - Free space

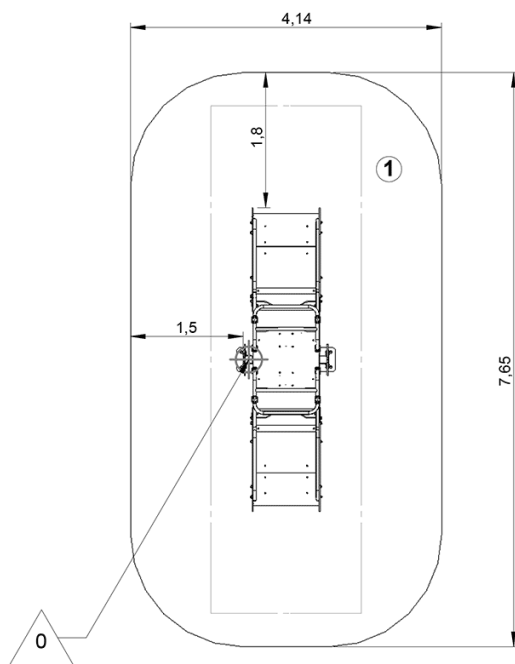

1	0,5m	30m ²
---	------	------------------



2



06h00



0m³



30m²



245kg



59kg

