

 **2+**
 **32**
 **3m**









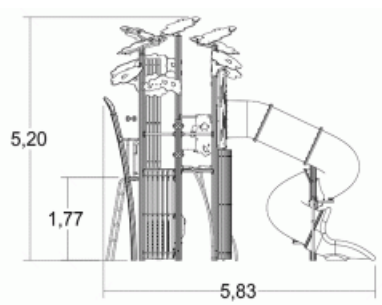
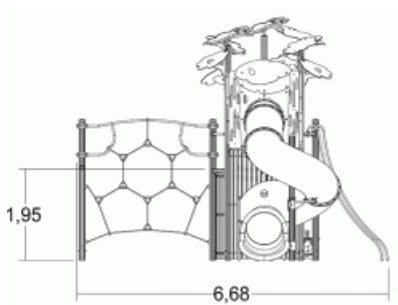







1 = 6,69m
2 = 5,83m
3 = 5,2m



Motor inclusion
 Sensory inclusion
 Mental inclusion



Play value : 26

role play	sliding	meeting	resting	handling	swinging	hiding	taking shelter
 x3	 x3	 x1	 x1	 x4	 x1	 x2	 x1
thinking	sound stimulation	tactile stimulation	visual stimulation	climbing	getting across		
 x2	 x1	 x2	 x1	 x3	 x1		

Components

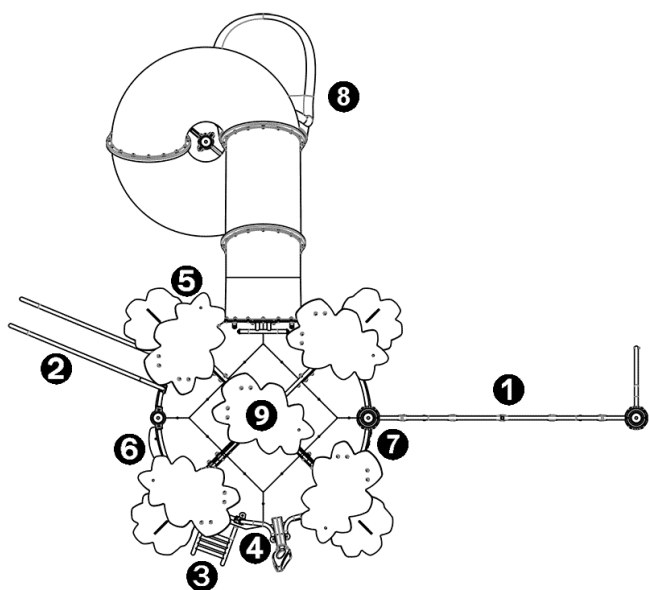

- 1 Net IXO
- 2 Speed slide
- 3 Ladder Ht: 1.77m
- 4 PANNEAU LUDIQUE BOULIER
- 5 palissade cabane
- 6 Shop
- 7 2-seater suspended seats
- 8 toboggan polyéthylène Ht : 2.37 m
- 9 plate-forme Ht : 2,37 m

Installation of equipment

IMPORTANT: It is essential to refer to the installation instructions for information on the size of the safety areas.

-  Impact area (minimum normative surface)
-  Free space

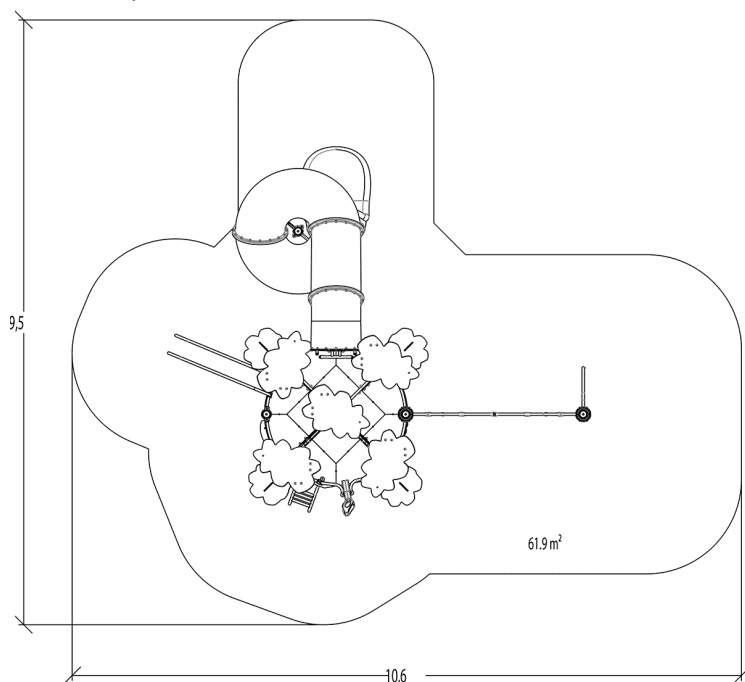

1	0,6m	9,5m ²
2	1m	9,5m ²
3	1,77m	6m ²
4	2,37m	7,5m ²
5	3m	30m ²



2



20h00



1.2m³



62.5m²



1247kg



41kg

