  
 > 1,40m    10    1,52m

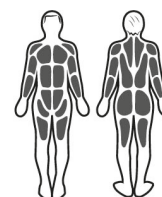

 1 = 6,52m  
 2 = 4,02m  
 3 = 2,75m



Sports formula

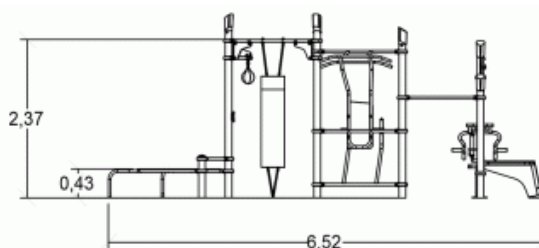
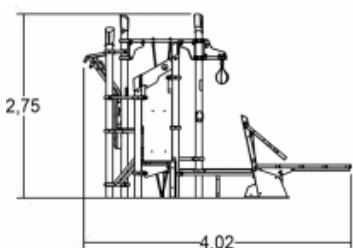

Muscular stimulation



► **Sports activities :**

**12**

hanging



x2

Pull-ups



x2

Dips



x1

Push-ups



x1

Abs



x2

boxing



x2

Resistance



x1

Soulever



x1

 muscle strengthening

 heart health

 balance

 coordination

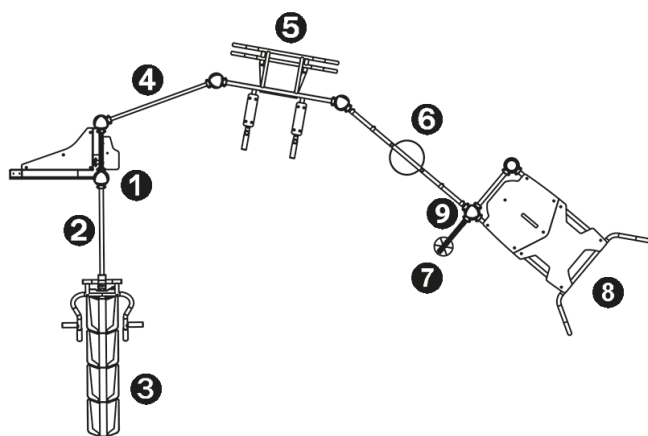

## ► Components



- ① 3 in 1 Totem
- ② Barre de connexion
- ③ Banc développé couché
- ④ Horizontal bar L. 125 cm
- ⑤ Chaise romaine
- ⑥ Punchbag
- ⑦ Punchball
- ⑧ Abs Board/Push-ups
- ⑨ Support téléphone

## ► Installation of equipment

**IMPORTANT:** It is essential to refer to the installation instructions for information on the size of the safety areas.

-  Impact area (minimum normative surface)
-  Free space

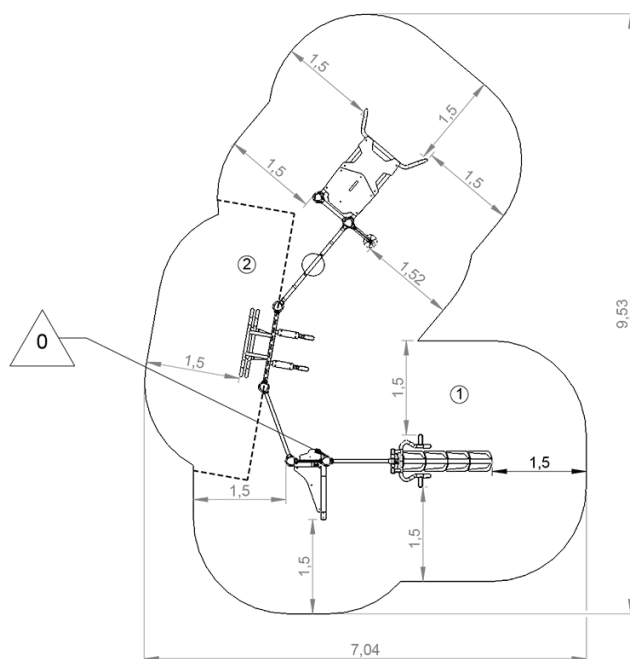

	Height (m)	Area (m <sup>2</sup> )
1	0,6m	36,5m <sup>2</sup>
2	1,27m	6m <sup>2</sup>
3	1,52m	4m <sup>2</sup>



2



25h00



1.4m<sup>3</sup>



46.5m<sup>2</sup>



457kg



24kg

