

Tolerances (mm)			
Dimension			Deviation
(1)	-	20	±0,2
(20)	-	50	±0,5
(50)	-	200	±1,0
(200)	-		±2,0

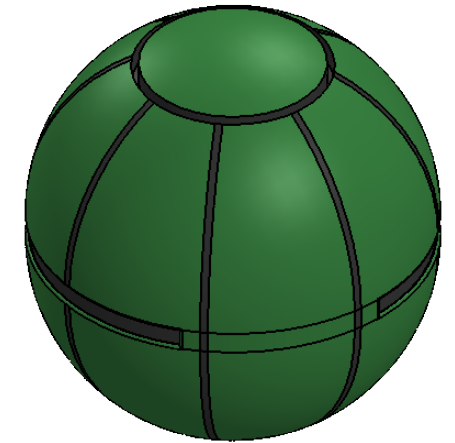
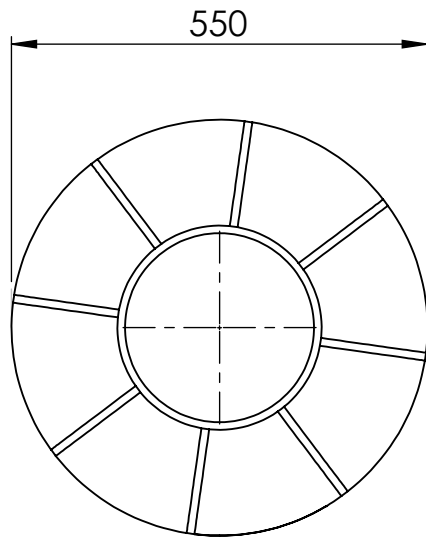
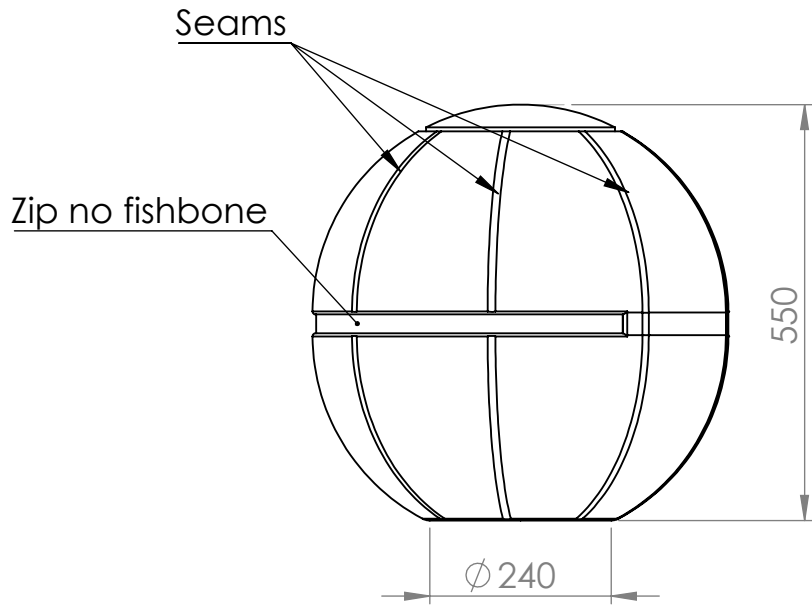

Material	X	Art.nr.	640055	Blad	1/1	A4
Skala	1:10	Sign.	Jonte	Benämning	Office Ballz 550 mm	
		Datum	2016-04-07	Rev	-	