

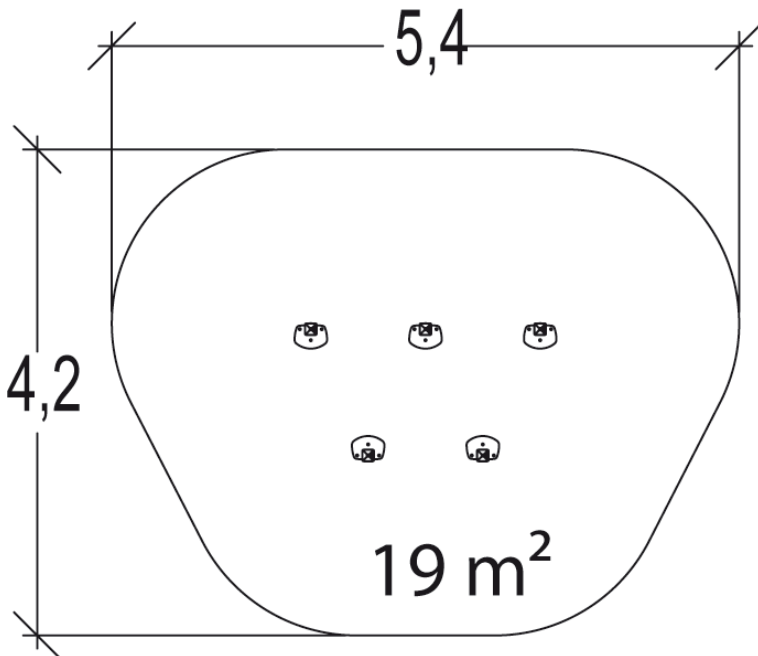

1=2.3m 2=1.2m 3=2.2m



INSTALLATION



0.15m³



2



03h00

OTHER INFORMATION



2 players

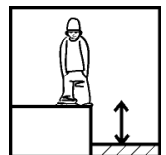

HCL= 0.55m

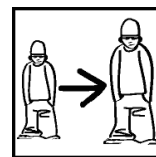

6+

CERTIFICATIONS

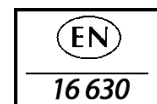

Total weight = 100 kg

Heaviest part = 18 kg