



2+



1



0,6m



1 = 1,05m 2 = 0,4m 3 = 0,68m



Motor disability

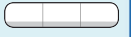

Sensorial disabilities

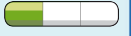

Learning disabilities

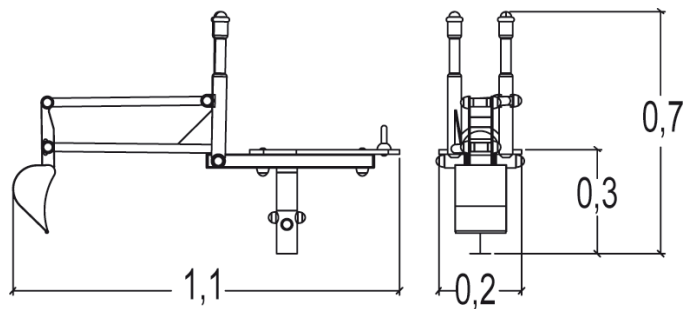
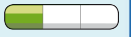

Play value : **1**

handling



x1

1 Digger

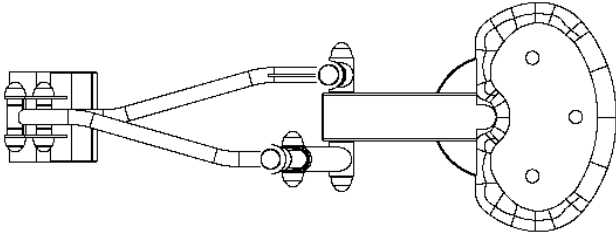



Installation of equipment

Impact area =

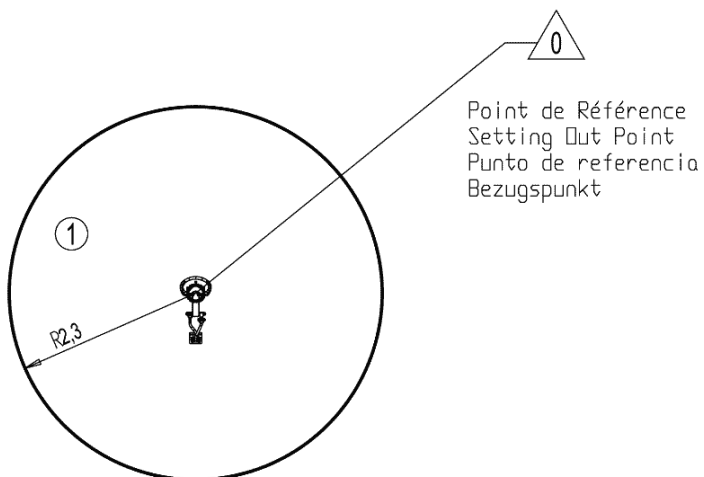
 Impact area
 Free space



		
1	<0,6m	17m ²



1



00h30



0.4m³



18m²



12kg



12kg

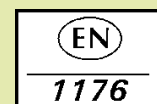

Proludic

2012-11-09