

1+ | **2** | **0m** | **1 = 1,09m 2 = 0,18m 3 = 0,9m**

 Motor disability
 Sensorial disabilities
 Learning disabilities

Installed on G3422 posts

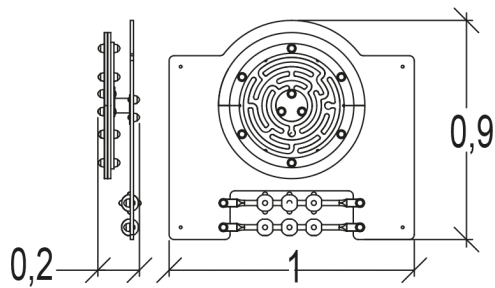
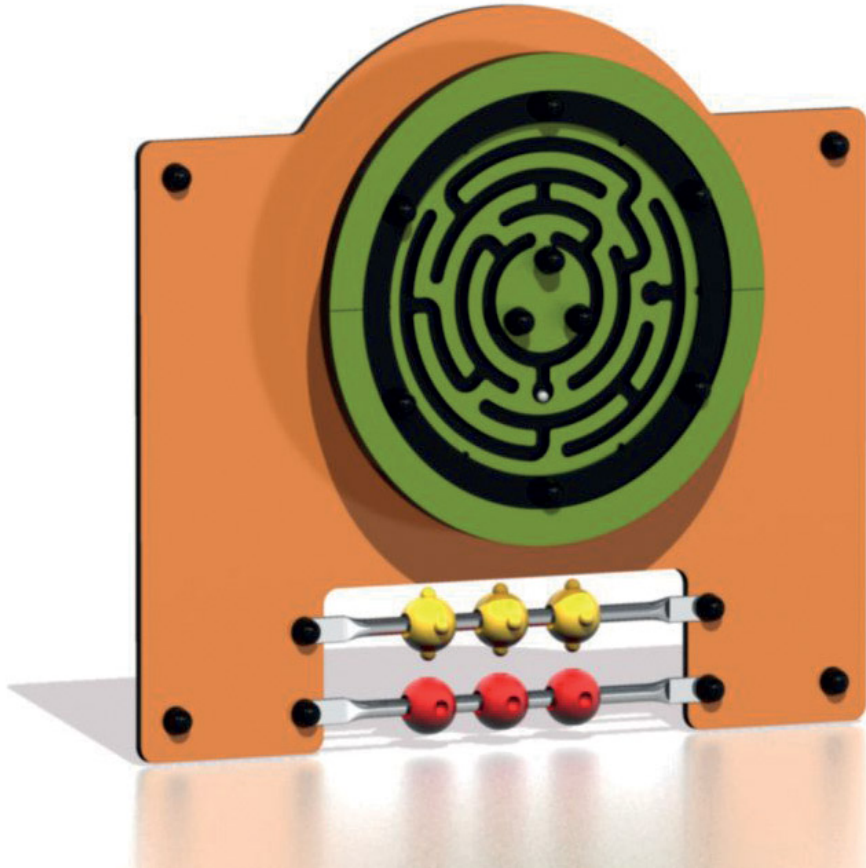

Play value : 2

handling



thinking



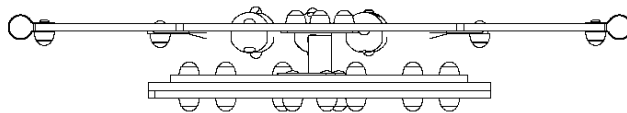







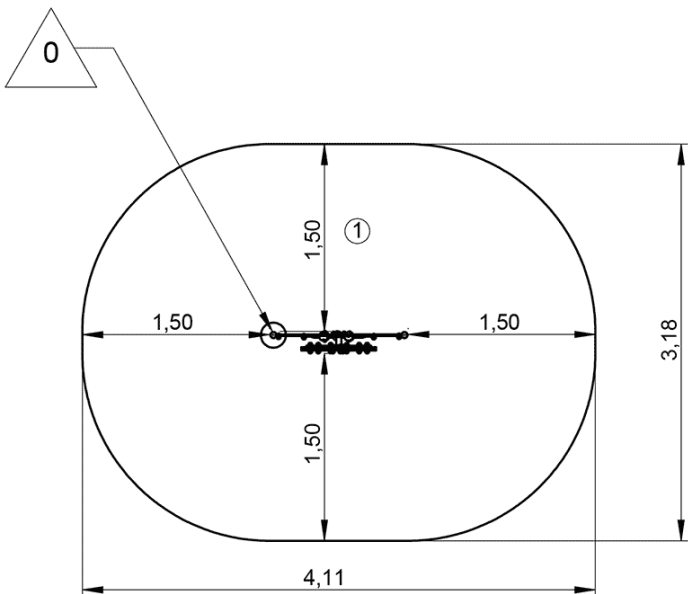



Installation of equipment

Impact area =

-  Impact area
-  Free space



		
1	0m	11m ²

							
2	00h45	0m ³	11m ²	33kg	17kg		0000-00-00