



1+



3



0m



1 = 0,76m 2 = 0,72m 3 = 0,59m



Motor disability
 Sensorial disabilities
 Learning disabilities

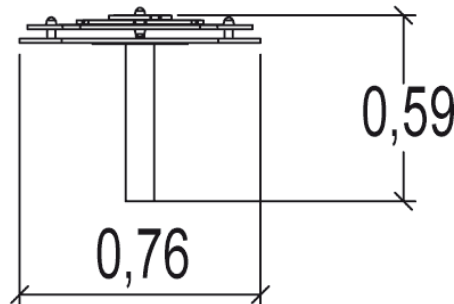
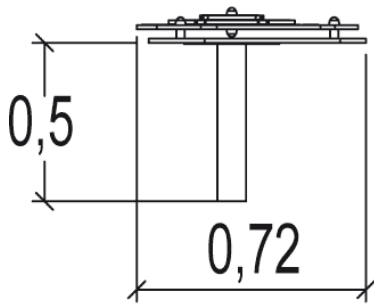
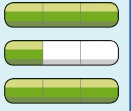

Play value : 3

handling



tactile stimulation



thinking



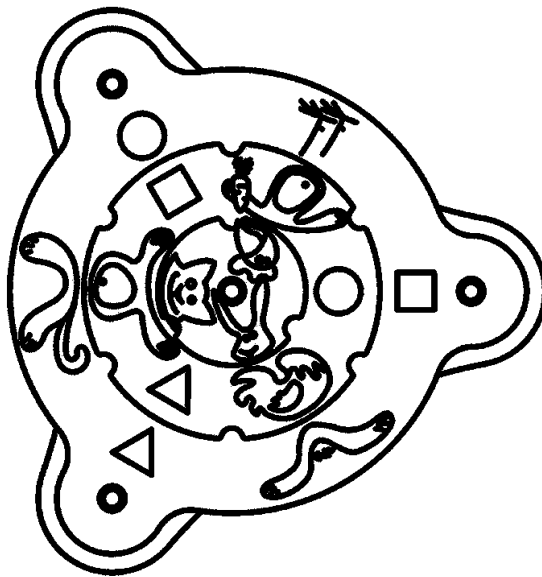







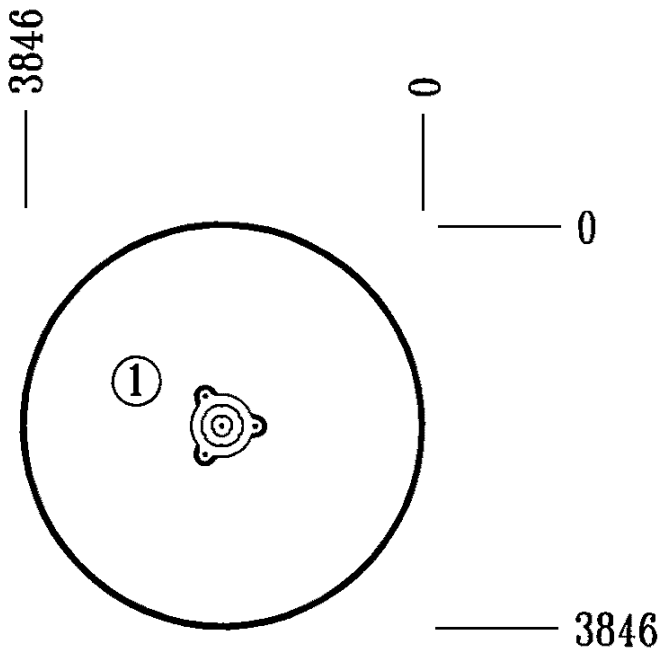



Installation of equipment

Impact area =

-  Impact area
-  Free space

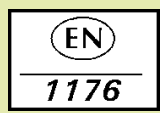

		
1	0m	12m ²

							
2	00h45	0.05m ³	12m ²	24kg	10kg		2013-03-07