



6+



35



2,5m



1 = 17m 2 = 10,3m 3 = 5m



Motor disability



Sensorial disabilities



Learning disabilities

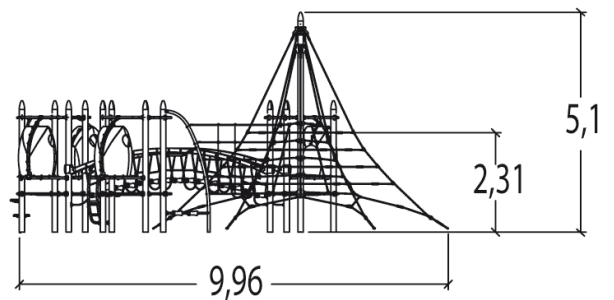
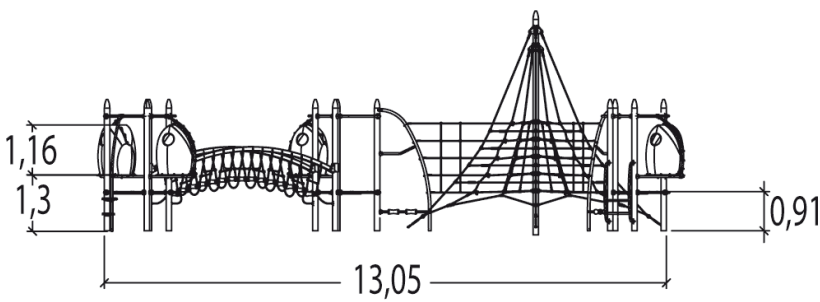
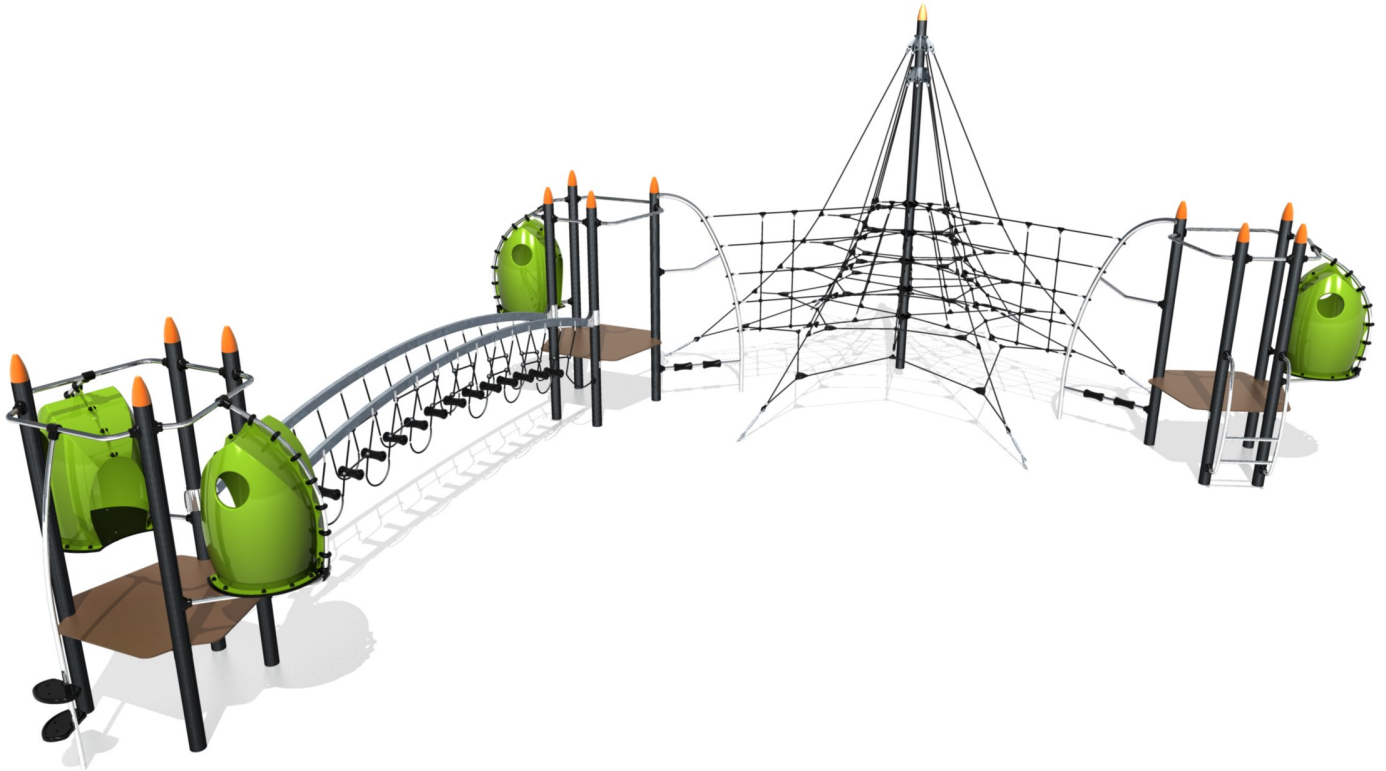

Play value : 12

meeting



x1

resting



x1

hiding



x1

balancing



x2

climbing



x4

getting across



x3

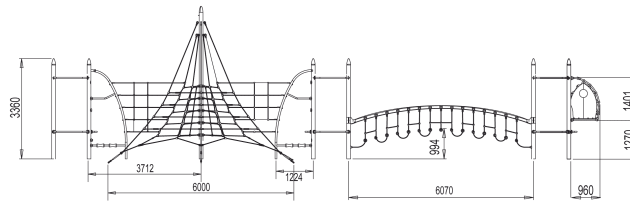



## Installation of equipment

Impact area =

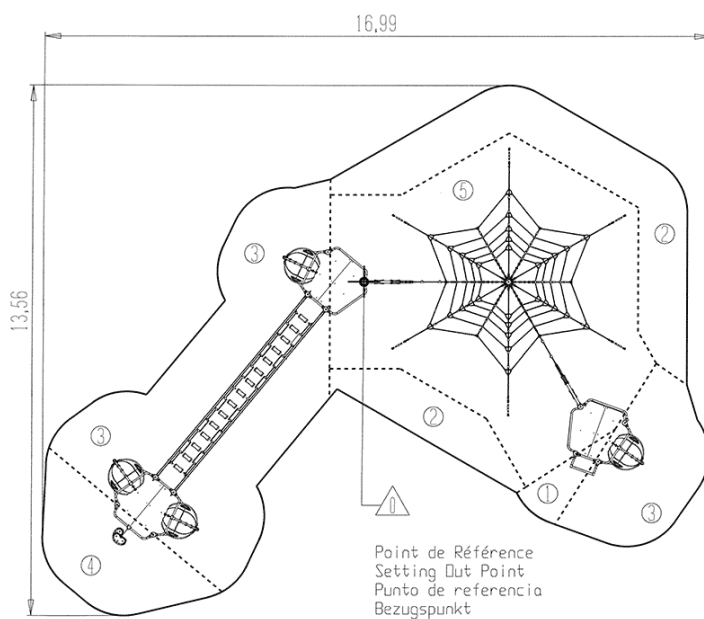
-  Impact area
-  Free space



		
1	0,9m	2m <sup>2</sup>
2	1,1m	22,5m <sup>2</sup>
3	1,3m	46,5m <sup>2</sup>
4	1,7m	10m <sup>2</sup>
5	2,5m	49m <sup>2</sup>



3



10h00



3.4m<sup>3</sup>



130m<sup>2</sup>



1283kg



146kg

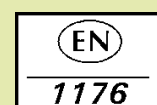

*Proludic*

2010-02-04