



1-8



6



0,3m



1 = 1,5m 2 = 0,75m 3 = 1,6m



Motor disability



Sensorial disabilities



Learning disabilities

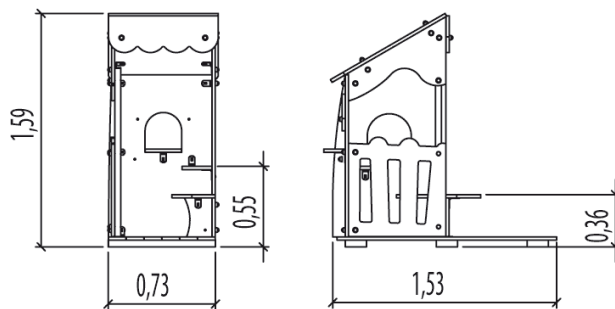
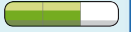

Play value :

2

meeting / role play



hiding / resting



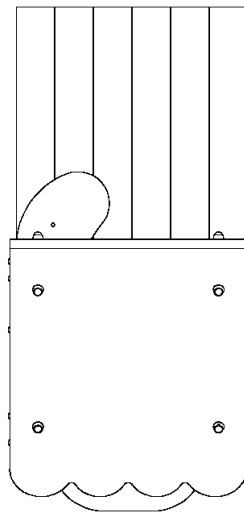



## Installation of equipment

Impact area =

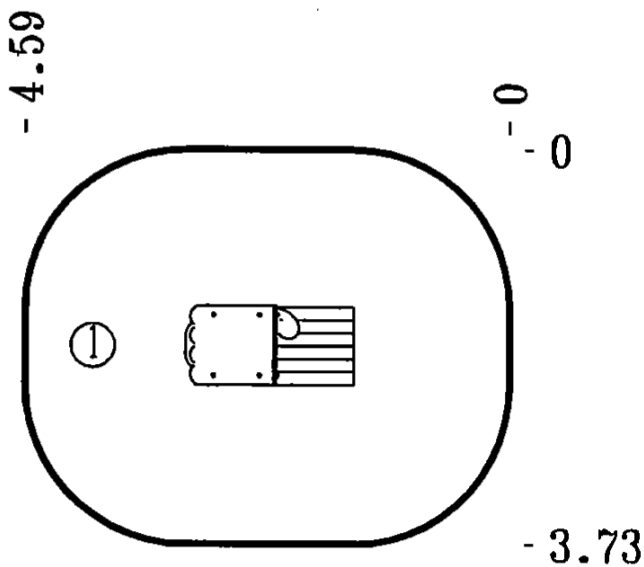
 Impact area  
 Free space



		
1	0,30m	15,5m <sup>2</sup>



2



01h30



0.1m<sup>3</sup>



15.5m<sup>2</sup>



90kg



27kg

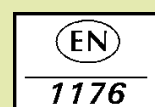

*Proludic*

2007-01-01