



3+



40



2,37m



1 = 16,5m 2 = 15,3m 3 = 6,65m

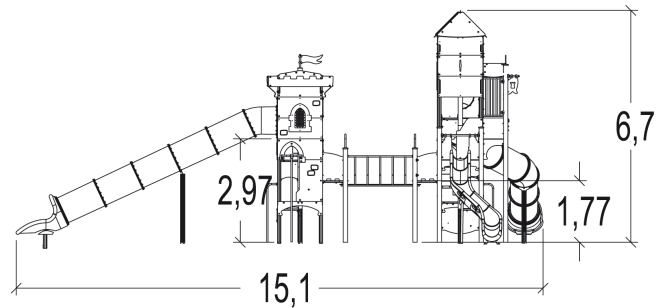
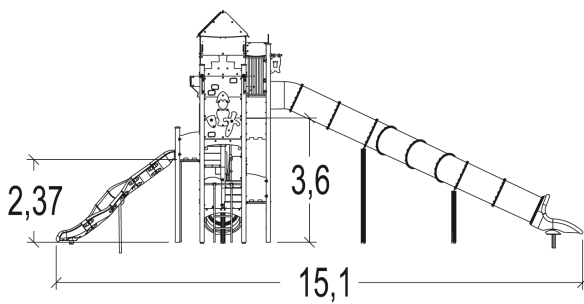

Play value : 16

climbing



x1

role play



x2

sliding



x3

meeting



x2

handling



x1

hiding



x2

taking shelter



x2

climbing



x2

getting across



x1

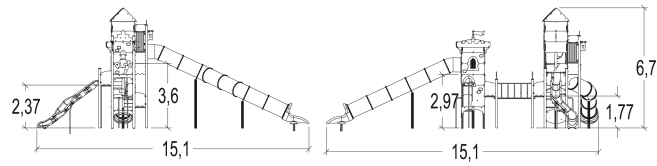



## Installation of equipment

Impact area =

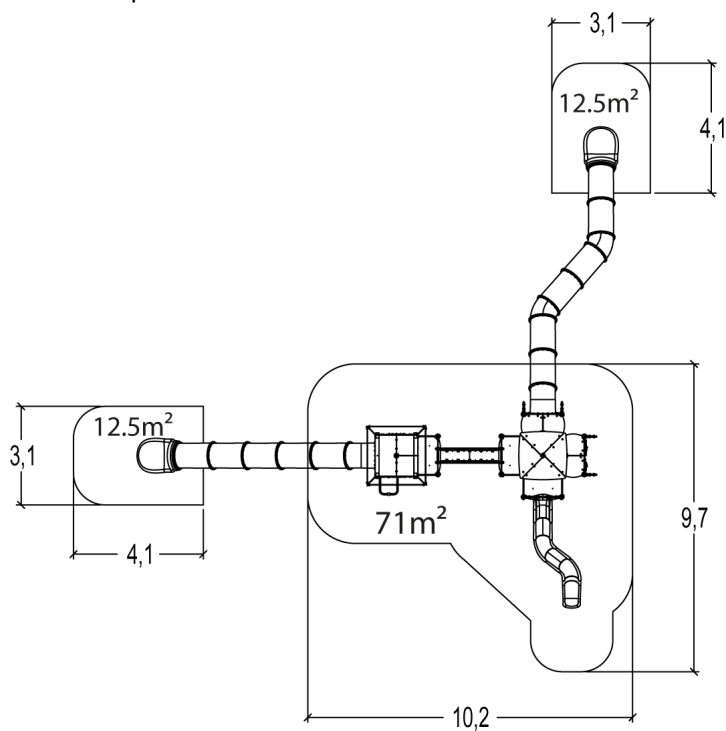
 Impact area  
 Free space



		
1	0,97m	15,5m <sup>2</sup>
2	1m	35m <sup>2</sup>
3	1,17m	14,5m <sup>2</sup>
4	1,77m	14m <sup>2</sup>
5	2,37m	17m <sup>2</sup>



4



00h00



5.1m<sup>3</sup>



96m<sup>2</sup>



2997kg



42kg

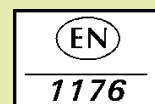

*Proludic*

2016-01-08