



2-8



20



1,17m



1 = 4,9m 2 = 1,3m 3 = 2,2m



Motor disability



Sensorial disabilities

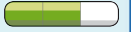

Learning disabilities

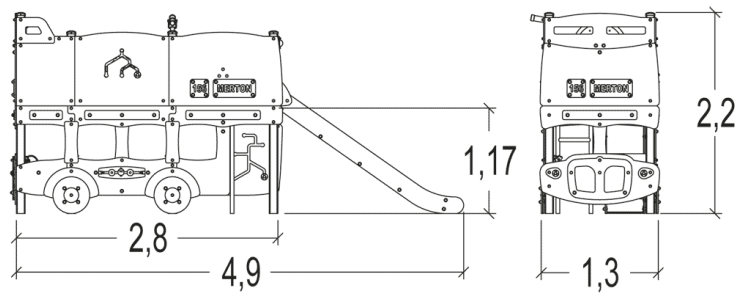

Play value : 2

handling



x1

visual stimulation



x1

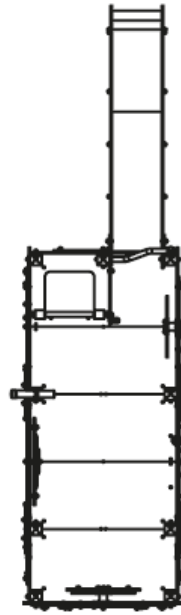

Installation of equipment

Impact area =

 Impact area
 Free space



— Zone d'impact
 Impact area
 Área de impacto
 Fallraum
 Valzone

 - - - Espace libre
 Free space
 Espacio libre
 Freiraum
 Vrije ruimte

 Point de référence
 Setting out point
 Punto de referencia
 Bezugspunkt
 Referentiepunt

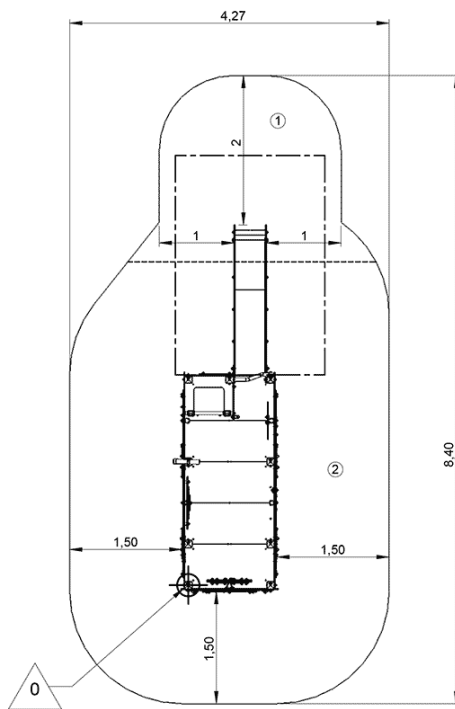
EN1176-1:2017
 EN1176-3:2017



		
1	1m	8,5m ²
2	1,17m	22m ²



2



21h00



0m³



30.4m²



602kg



18kg

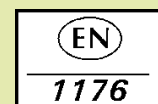

Proludic

2014-01-09