



2-6



4



0,6m



1 = 2,57m 2 = 1,18m 3 = 1,75m



Motor disability



Sensorial disabilities



Learning disabilities

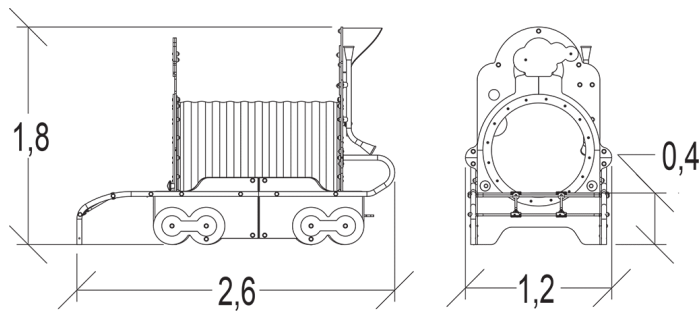
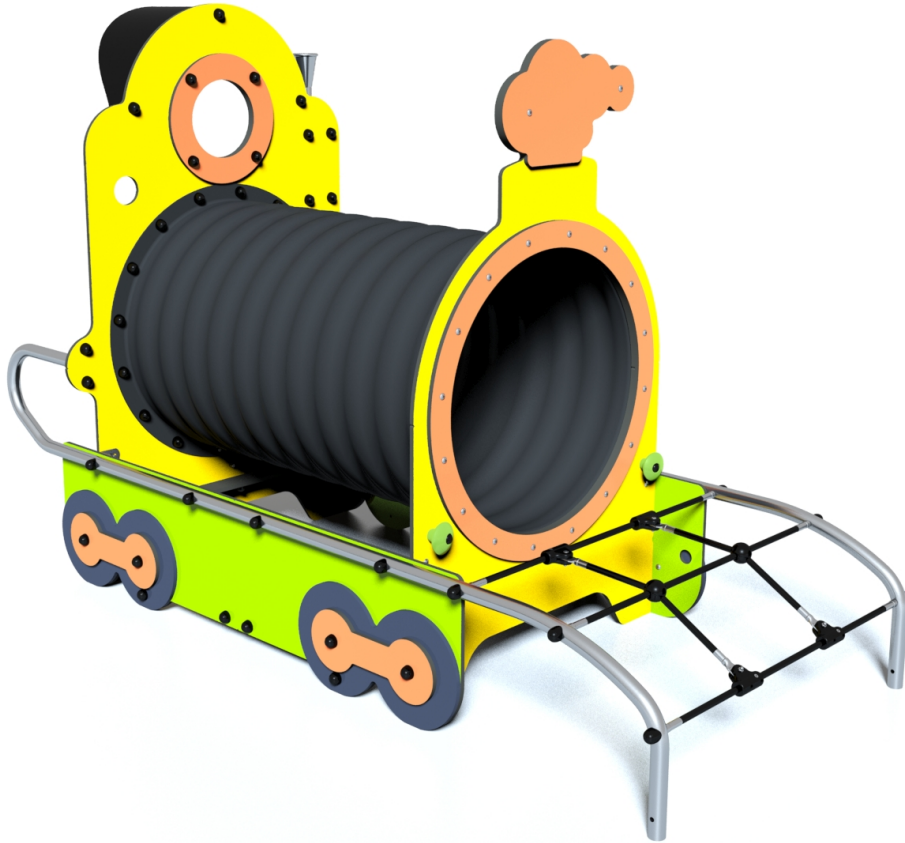

Play value : 9

role play



x1

meeting



x1

handling



x1

crawling



x1

hiding



x1

sound stimulation



x1

visual stimulation



x1

climbing



x1

getting across



x1

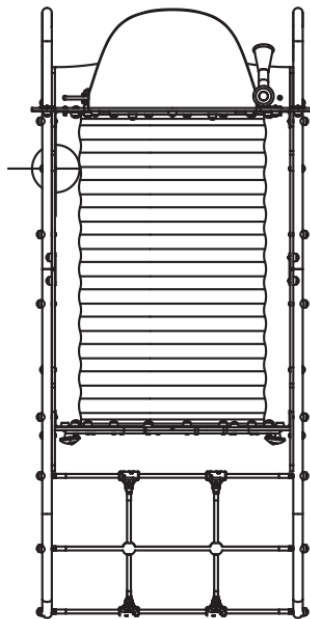







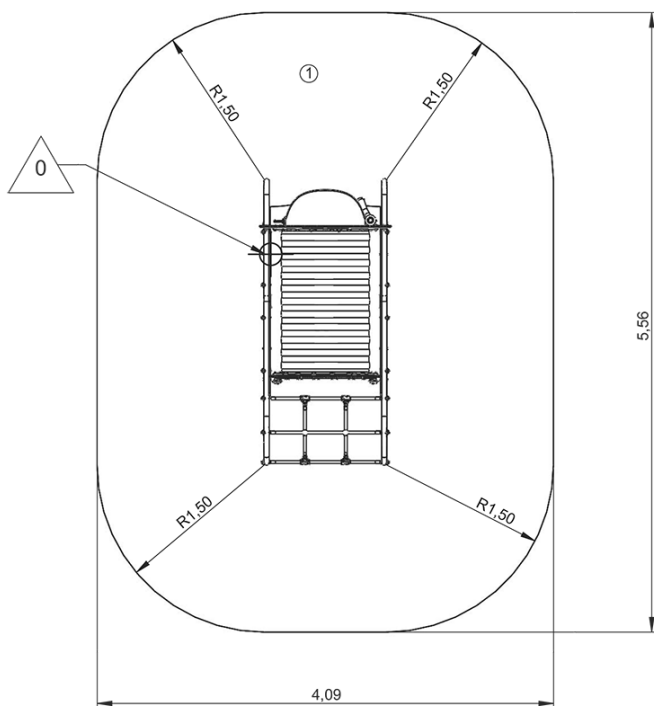



Installation of equipment

Impact area =

-  Impact area
-  Free space

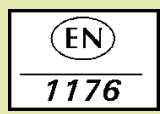

		
1	0,6m	21m ²

							
2	03h00	0.2m³	21m²	134kg	16kg		0000-00-00