



3+



60



2,37m



1 = 20m 2 = 13m 3 = 7m

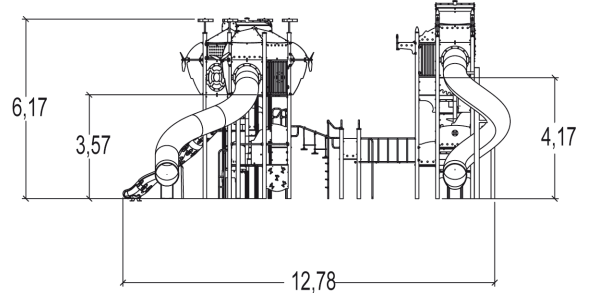
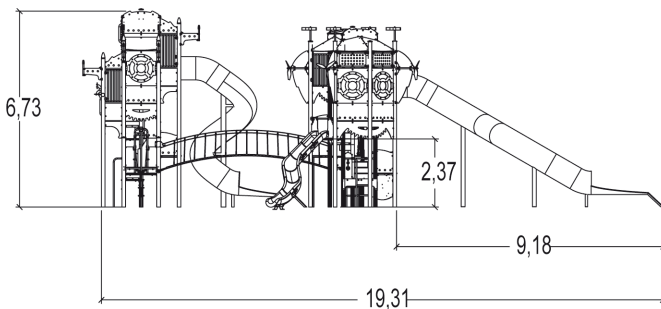
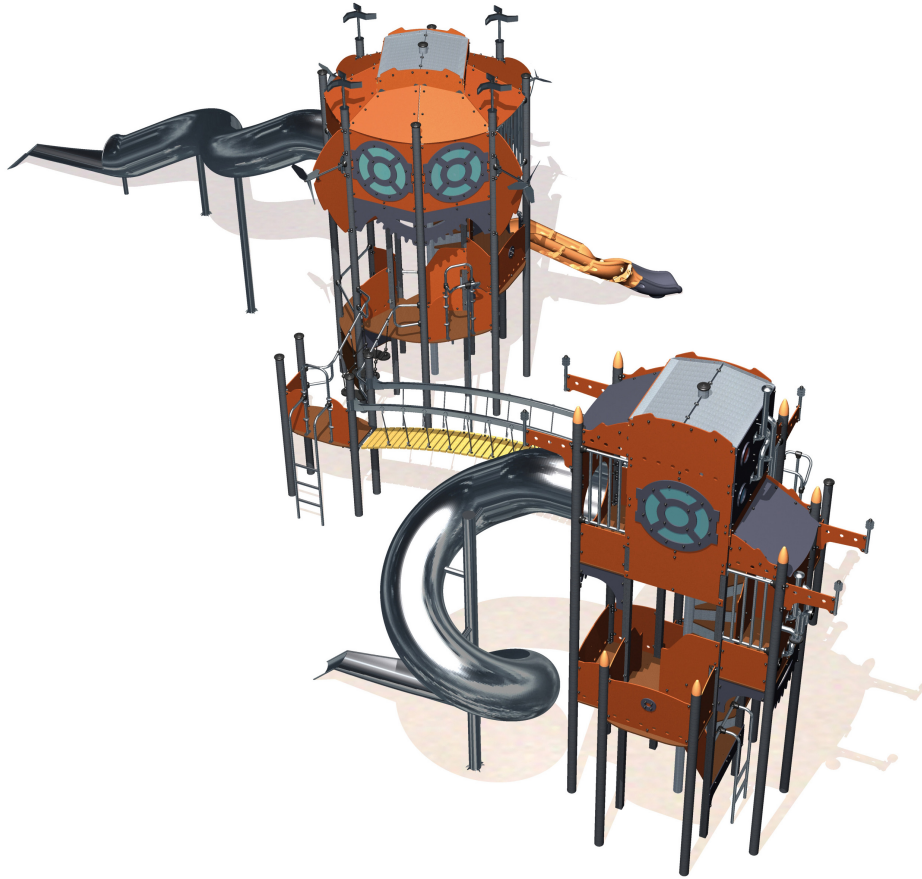

Play value : 22

climbing



x1

role play



x2

sliding



x4

meeting



x2

handling



x1

hiding



x2

balancing



x1

taking shelter



x2

climbing



x4

getting across



x3

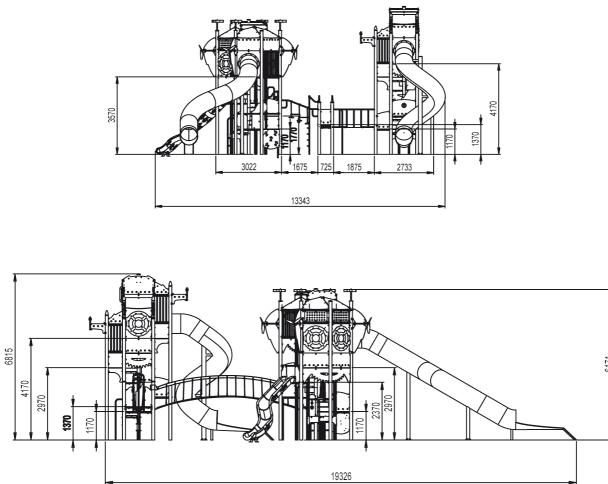



## Installation of equipment

Impact area =

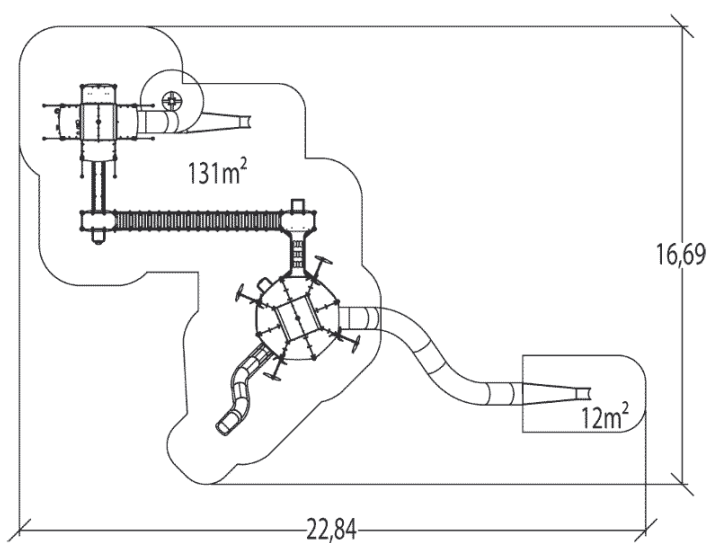
-  Impact area
-  Free space



		
1	0,97m	9m <sup>2</sup>
2	1m	34,5m <sup>2</sup>
3	1,17m	12,5m <sup>2</sup>
4	1,37m	39m <sup>2</sup>
5	1,77m	17,5m <sup>2</sup>
6	2,37m	35,5m <sup>2</sup>



0



00h00



0m<sup>3</sup>



148m<sup>2</sup>



5799kg



700kg

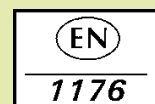

*Proludic*

2010-02-04