



3+



20



2,6m



1 = 5,11m 2 = 4,1m 3 = 3m

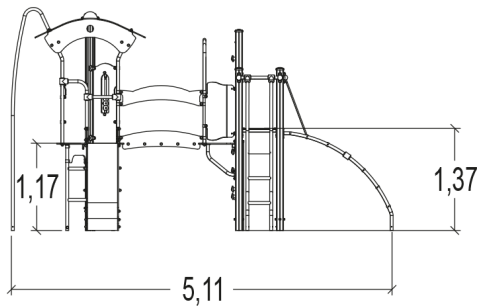
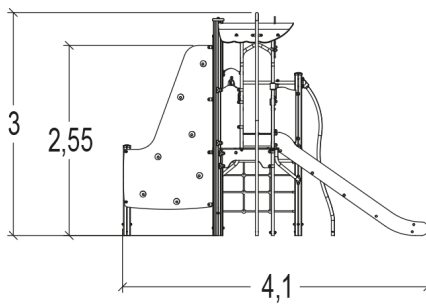

Play value :

19

climbing



x2

role play



x1

sliding



x3

meeting



x3

handling



x2

taking shelter



x1

thinking



x1

tactile stimulation



x1

visual stimulation



x1

climbing



x3

getting across



x1

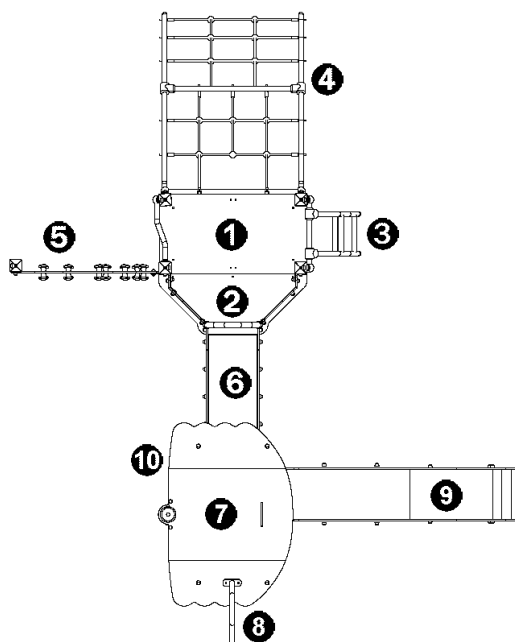

- ① Rectangular platform
- ② Platform HT: 1.17m
- ③ Curved ladder
- ④ Incline net H: 1.37m
- ⑤ Climbing wall
- ⑥ Walkway
- ⑦ Tower HT: 1.17m
- ⑧ Fireman's pole
- ⑨ Slide
- ⑩ Counting panel

Installation of equipment

Impact area =

- Impact area
- Free space

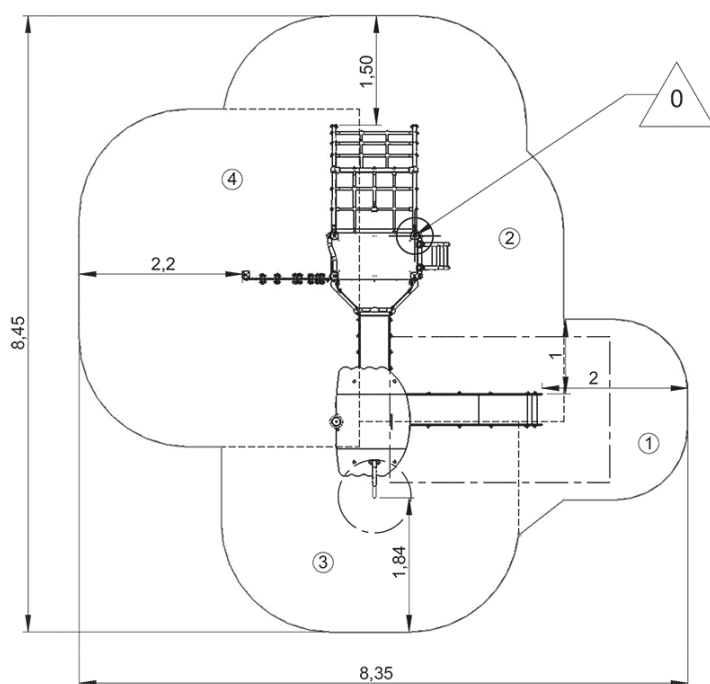

1	1m	5m ²
2	1,37m	16m ²
3	2m	10,5m ²
4	2,6m	17m ²



2



14h00



0.4m³



48.5m²



398kg



33kg

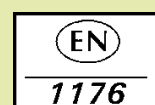

Proludic

0000-00-00