

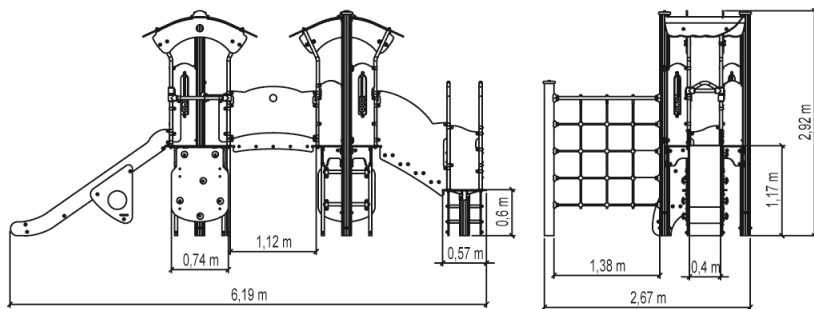







2+ | **30** | **1,8m** | **1 = 6,18m 2 = 2,71m 3 = 2,9m**

 Motor disability
 Sensorial disabilities
 Learning disabilities



Play value : **13**

 climbing x1	 sliding x1	 meeting x2	 resting x1	 handling x1	 taking shelter x1	 climbing x4	 getting across x2
---	--	--	--	---	--	---	---

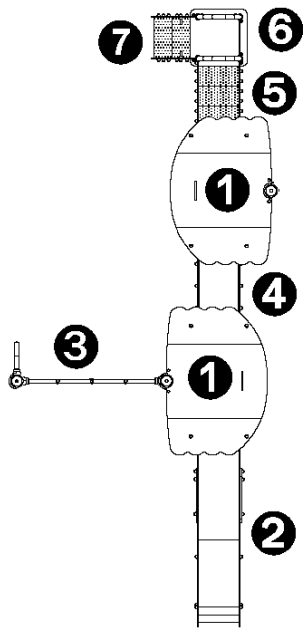

- ① Tower HT: 1.17m
- ② Slide HT: 1.17m
- ③ Climbing net
- ④ Walkway
- ⑤ Connecting staircase
- ⑥ Platform HT: 0.6m
- ⑦ Steps
- ⑧ Post
- ⑨ Post ladder
- ⑩ Climbing wall
- ⑪ Seat
- ⑫ Counting panel

Installation of equipment

Impact area =

- Impact area
- Free space

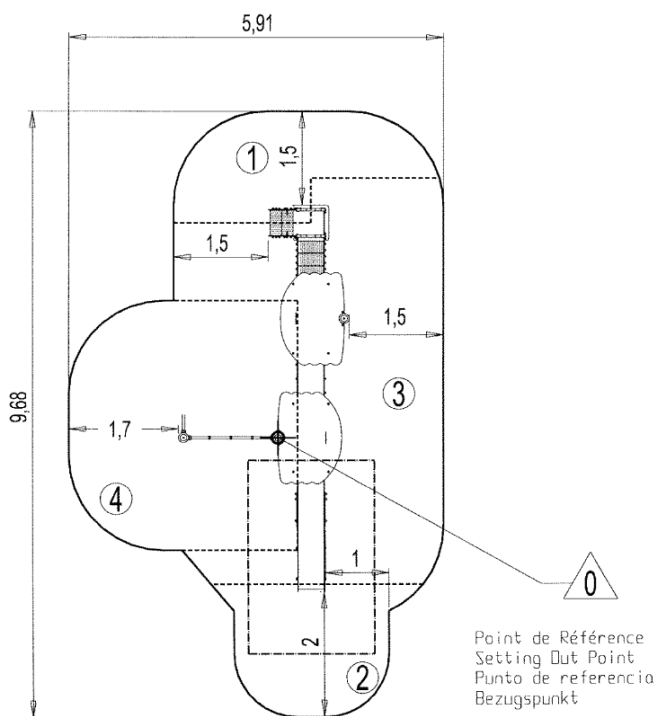

1	0,6m	5,5m ²
2	1m	5m ²
3	1,17m	17,5m ²
4	1,8m	12,5m ²



2



20h00



0.3m³



40.5m²



473kg



33kg



Proludic

2009-01-01