



2+



12



1,98m



1 = 2,69m 2 = 2,13m 3 = 1,98m

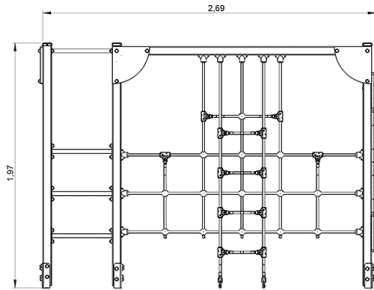
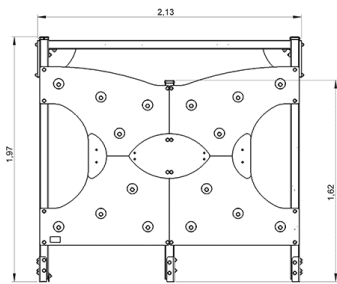
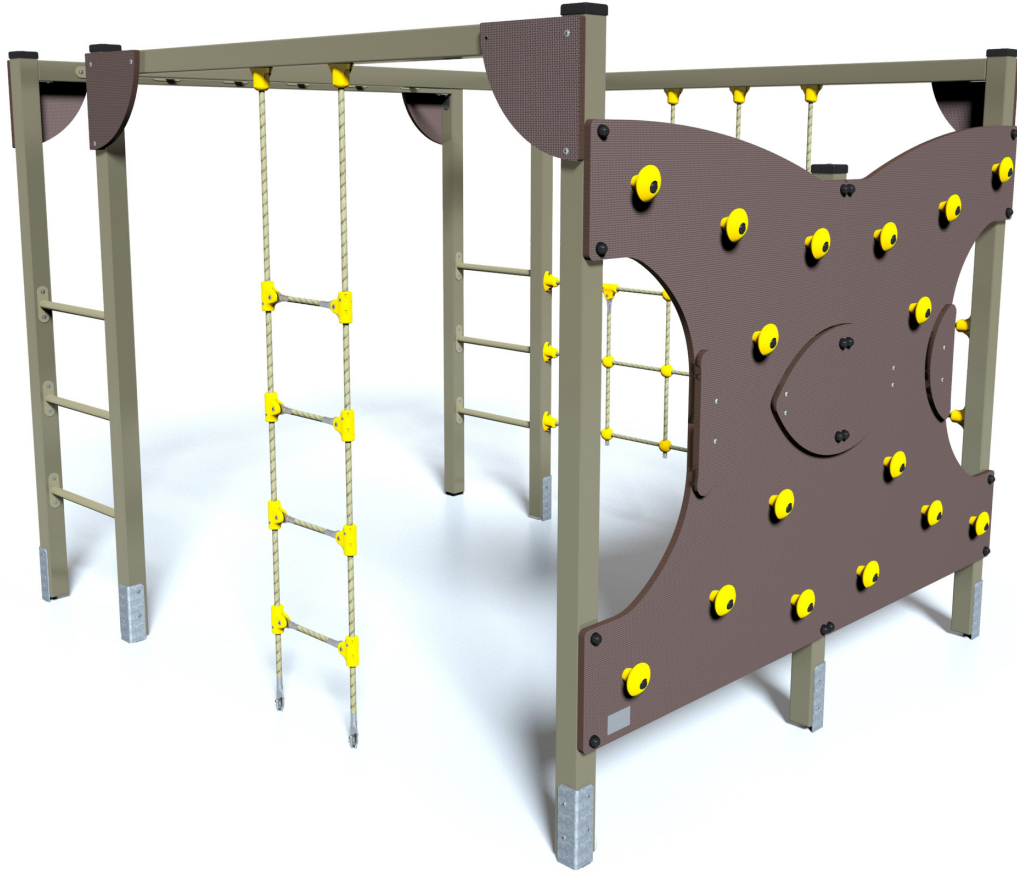

Play value : 4

climbing



climbing



hanging



getting across



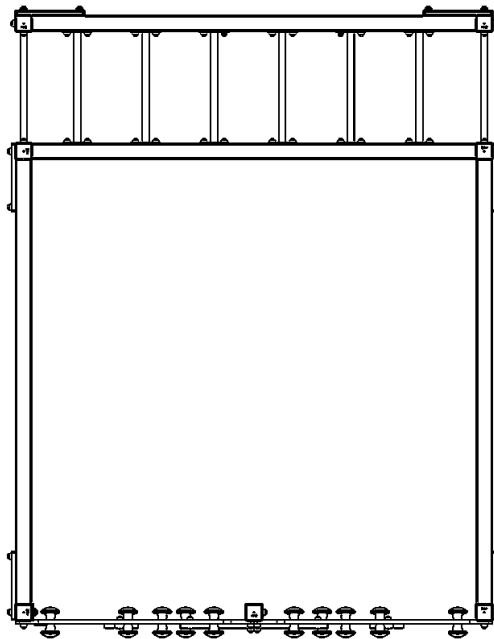



Installation of equipment

Impact area =

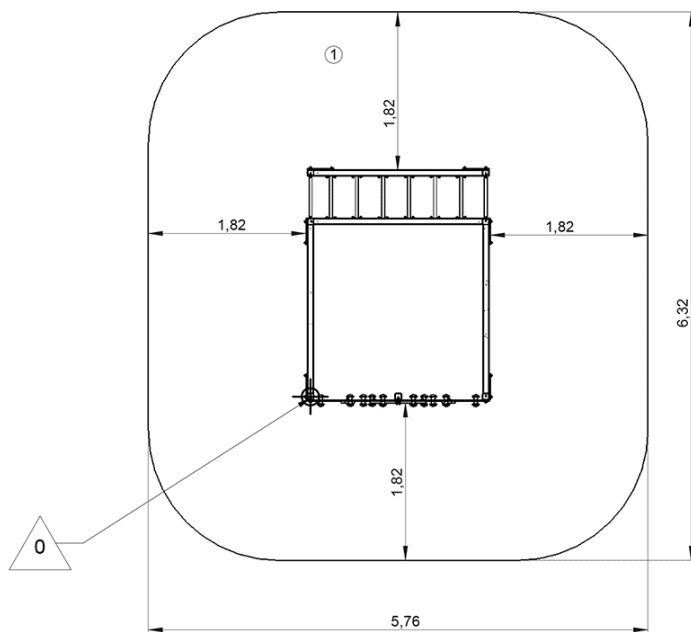
-  Impact area
-  Free space



		
1	1,98m	34,5m ²



2



04h00



0.25m³



34.5m²



155kg



6kg

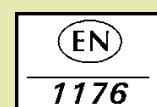

Proludic

0000-00-00