



1+



4



0,6m



1 = 1,05m 2 = 1,03m 3 = 1,21m

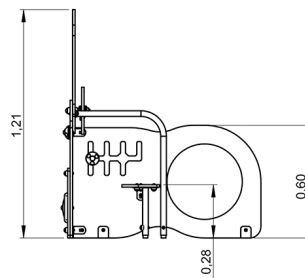
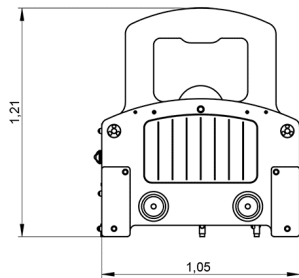
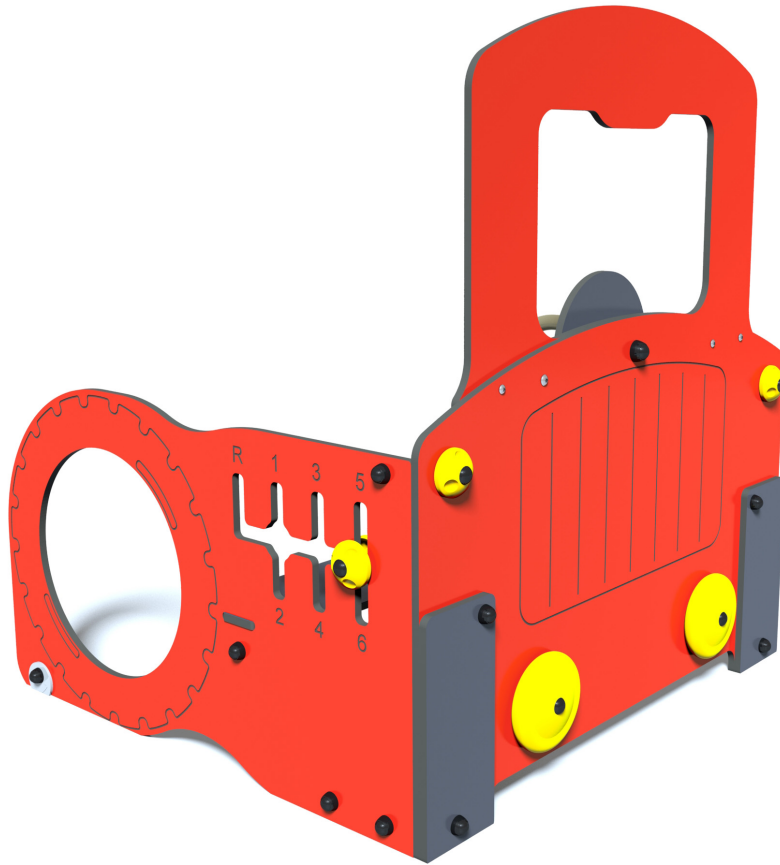

Play value : 5

meeting



role play



crawling



handling



resting



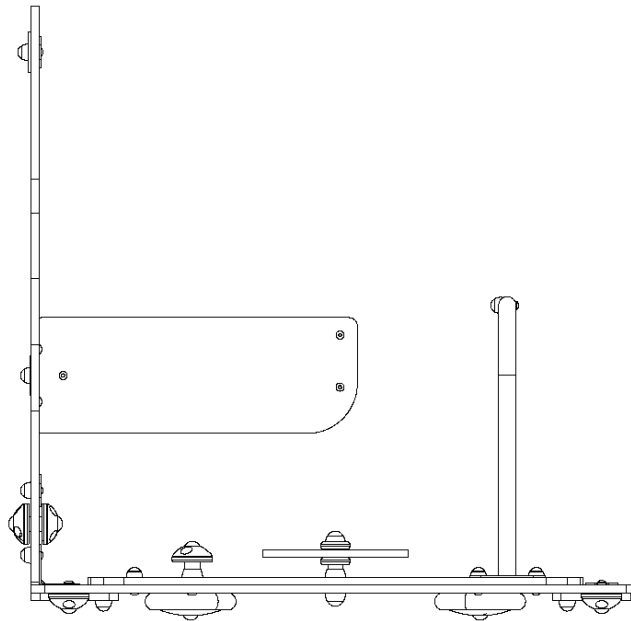







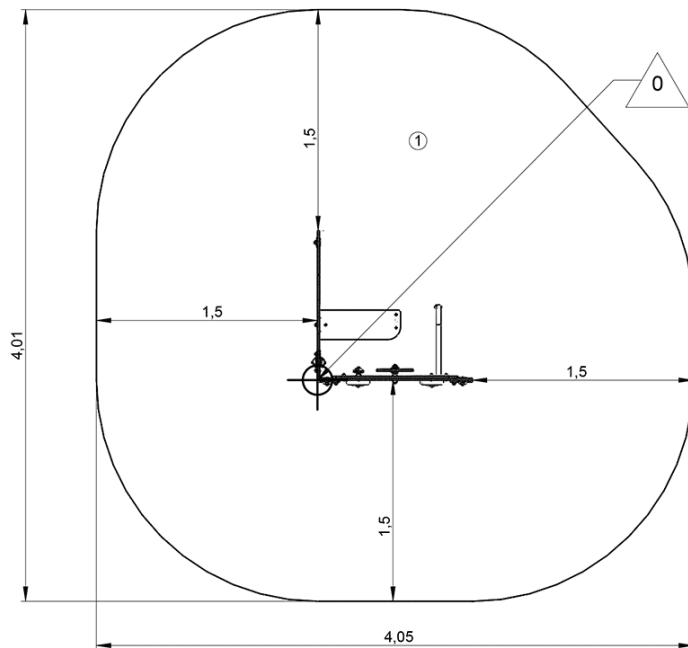



## Installation of equipment

Impact area =

-  Impact area
-  Free space

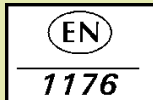

		
1	<0,6m	14m <sup>2</sup>

							
2	03h00	0.15m <sup>3</sup>	14m <sup>2</sup>	65kg	6kg		0000-00-00