

**1+** | **8** | **0,6m** | **1 = 1,76m** **2 = 0,6m** **3 = 1,97m**

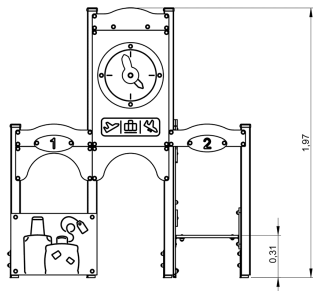

**Play value : 6**

role play

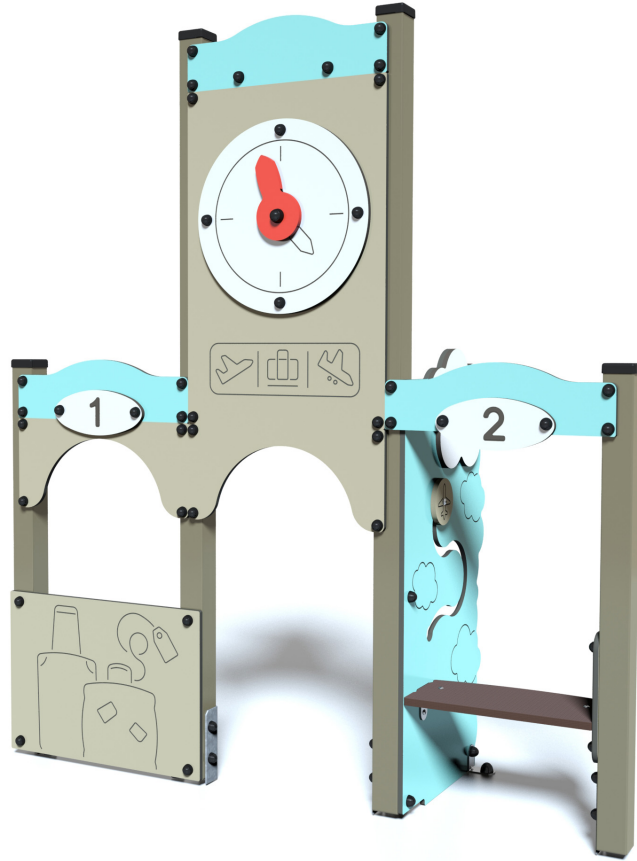

meeting



tactile stimulation



visual stimulation



handling



resting



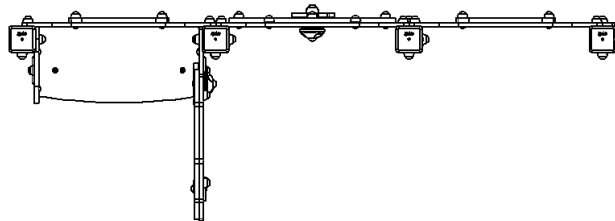







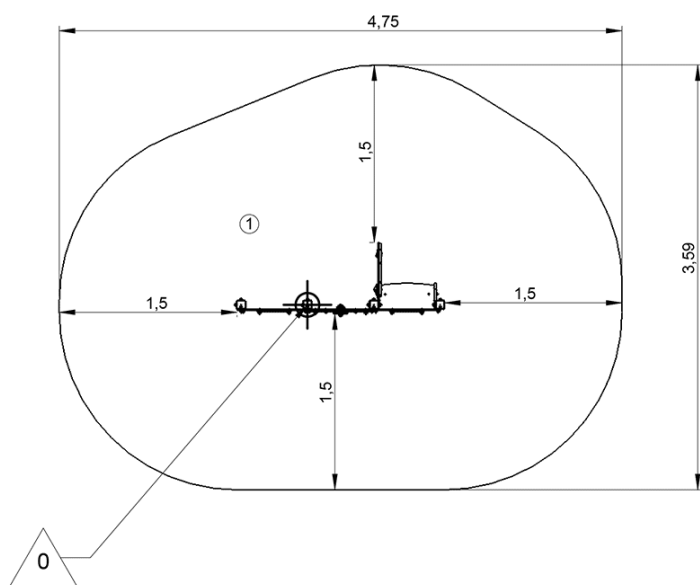

## Installation of equipment

Impact area =

-  Impact area
-  Free space



		
1	<0,6m	14m <sup>2</sup>

					
2	04h00	0.15m <sup>3</sup>	14m <sup>2</sup>	120kg	6kg

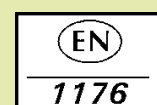

0000-00-00