



D»		
F	FÁ	ÌJÁ
G	FÈÁ	FÈÁ

— Z] ^ÁÁ] æc
 Q] æ0æ^æ
 OÈ^æÁÁ] æ&f
 Øæ|æ {
 Xæ [] ^



Ú[á cæ^Á...!^} &
 U^æ * Á ~ ç [á c
 Ú ~ } ç Á^Á^!^} &æ
 O^: * .] ~ \ c
 Ú^!^!} ç ~ } c

--- Ò] æ^Áá!^
 Ø^ÁÁ] æ^
 Ò] æá Áá!^
 Ø^áæ {
 X!æÁ á ç

ÒPFFI Ì ÈIGE17ÁÁ
 ÒPFFI Ì ÈIGE17ÁÁ

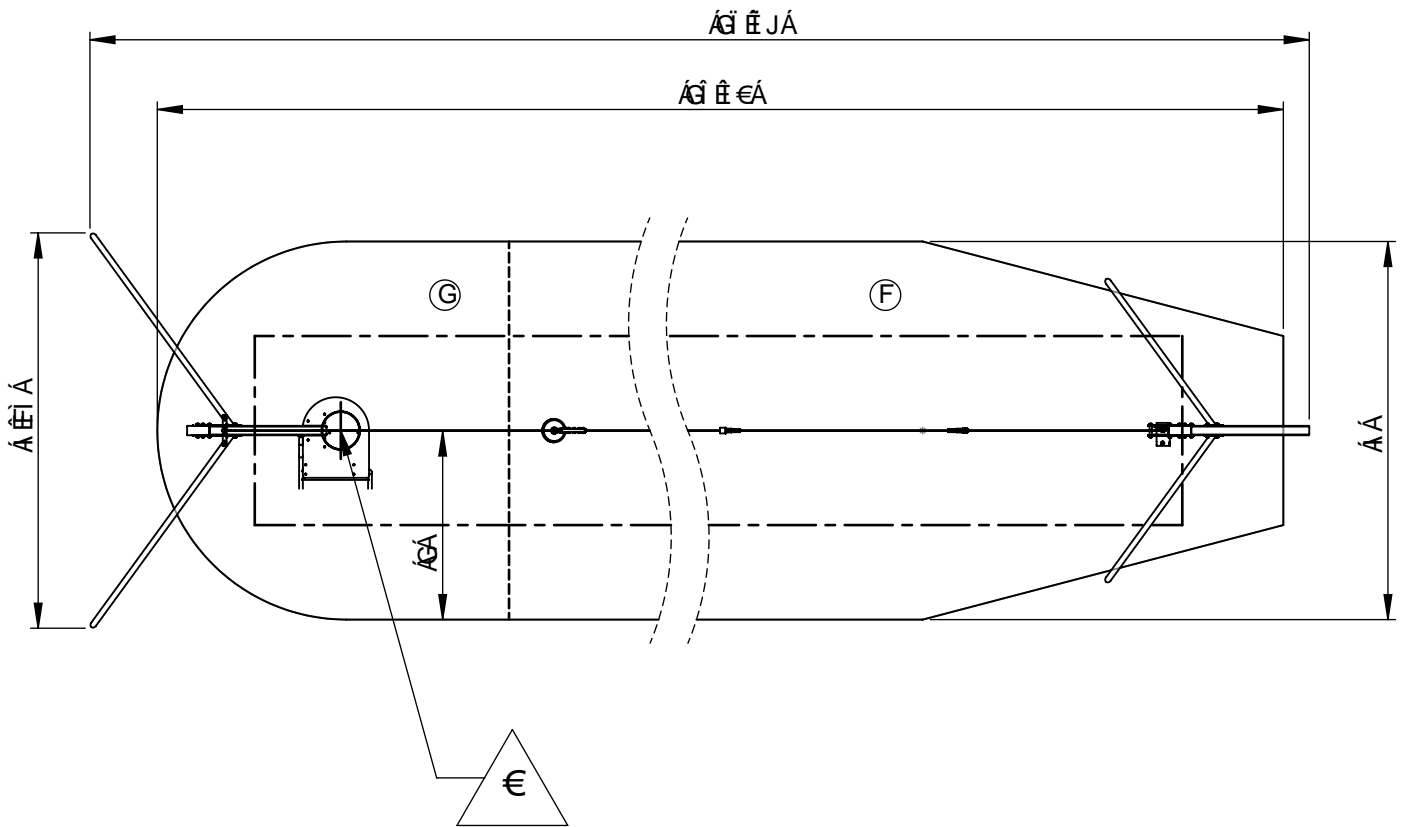

— Zone d'impact
Impact area
Area de impacto
Fallraum
Valzone

102.5 m²

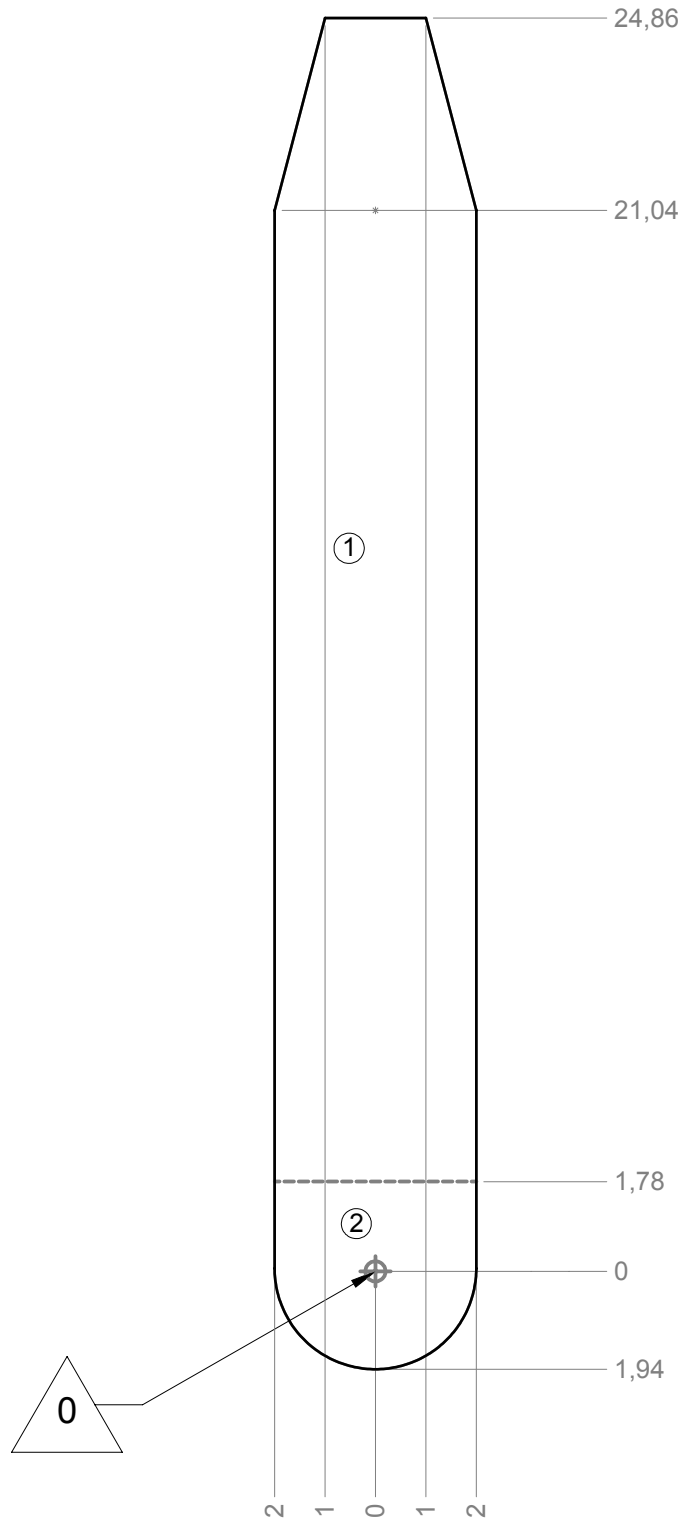

— Ü | Á ^ c
 S [· Á æ cæ | ^ Á æ æ ! æ æ
 Q E ^ } ^ |
 S [· ^ · Á O [á ^ } { æ æ ! æ æ
 S [· Á [á ^ { æ æ ! æ æ æ

Ì F Á
 F Ì H Á

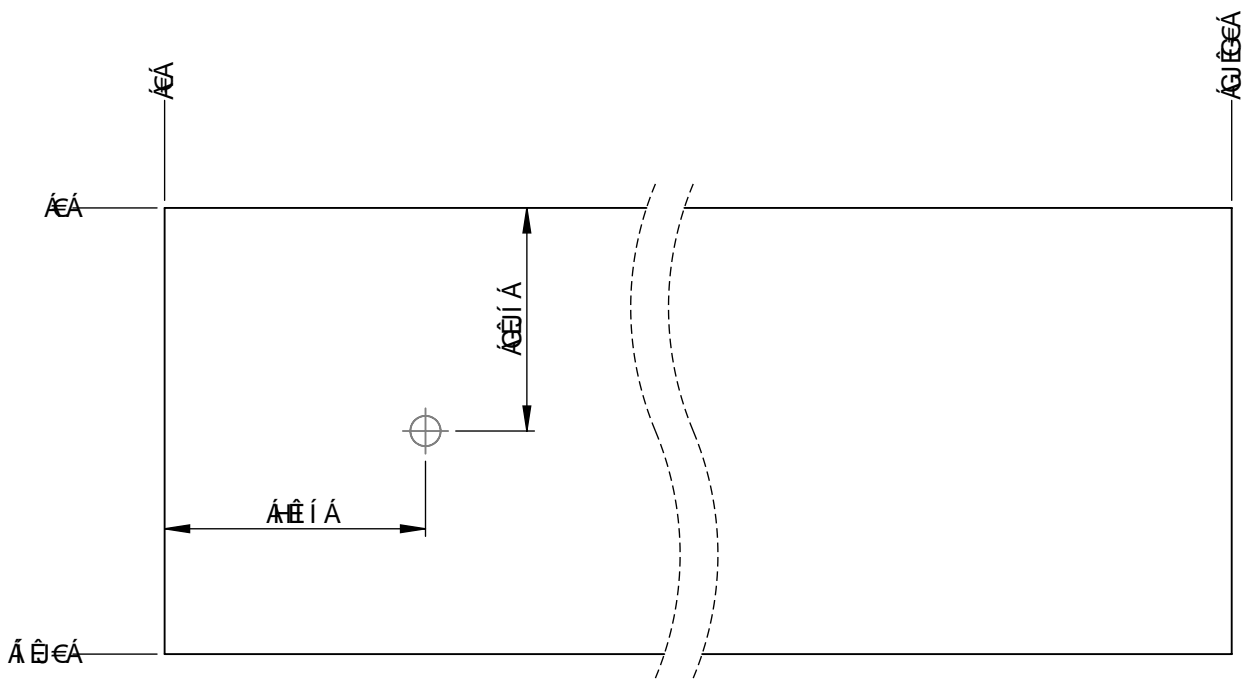

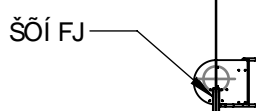
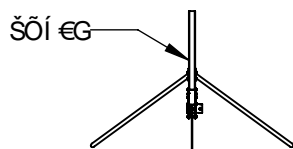

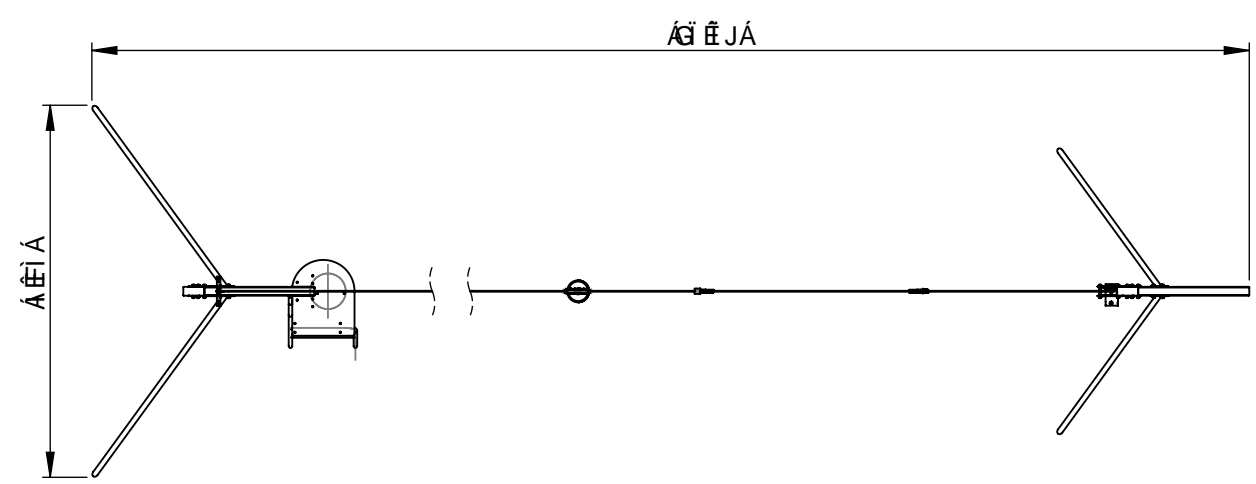
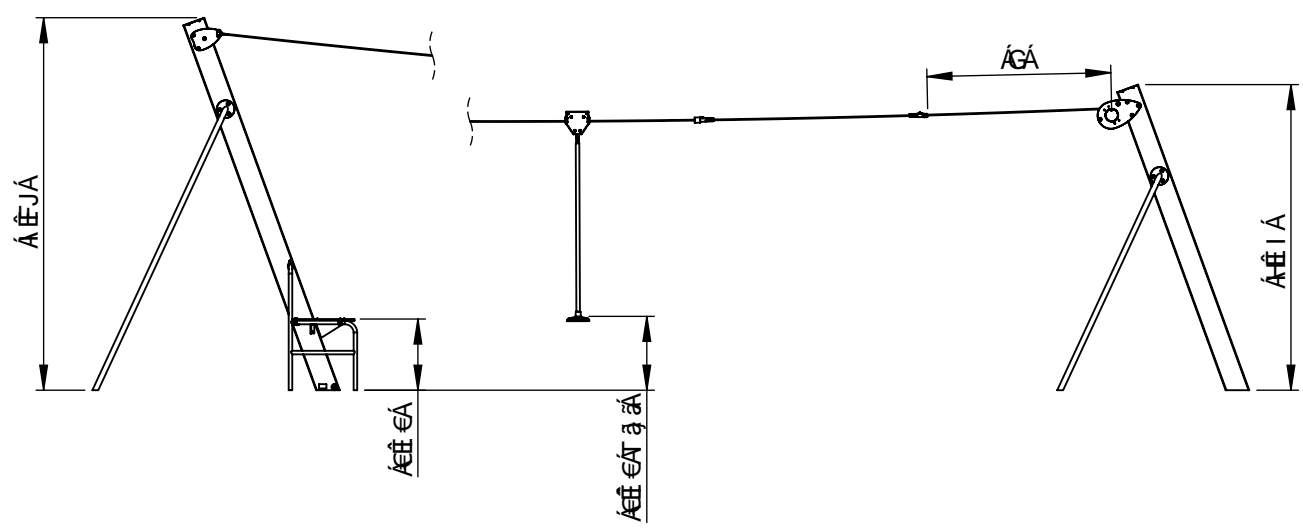



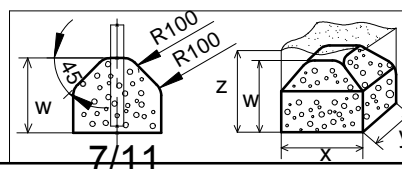
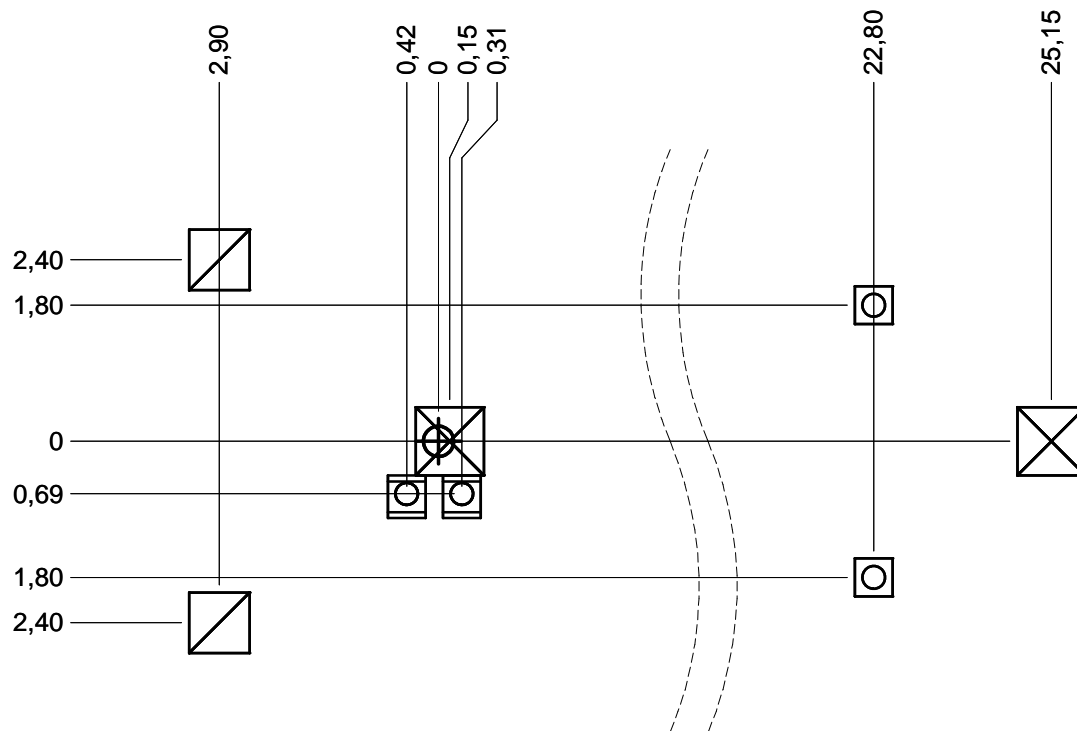



Implantation
 Footing plan
 Implantación
 Fundamentplan
 Funderingstekening



 x2
 20H
 2 m³

	x	y	w	z
	0.5	0.5	0.3	0.6
	0.8	0.8	0.5	0.8
	0.9	0.9	0.6	0.8

1

