

# Water play unit "Havel"

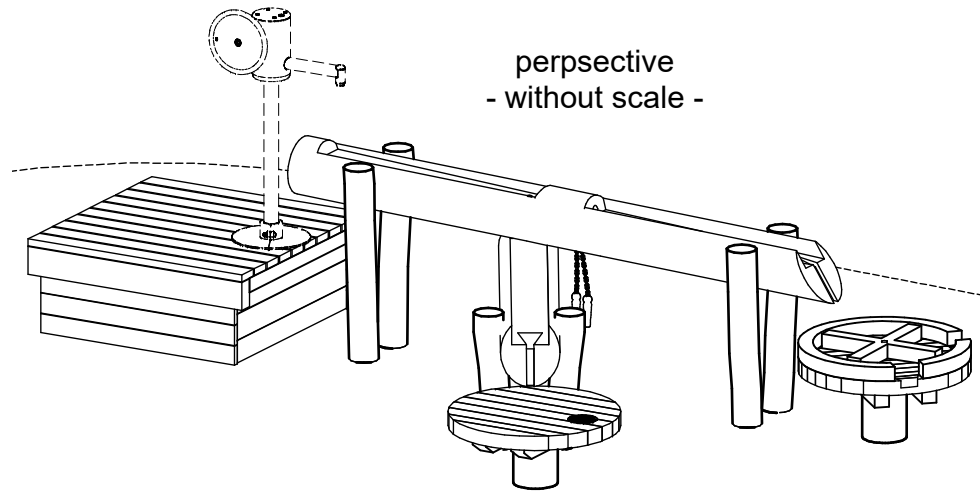

topview with  
minimum safety area

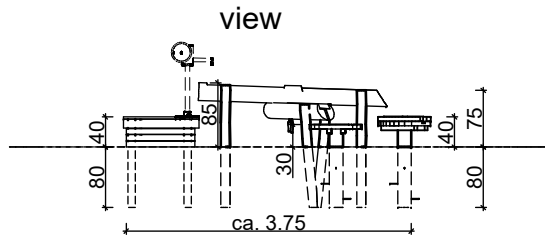
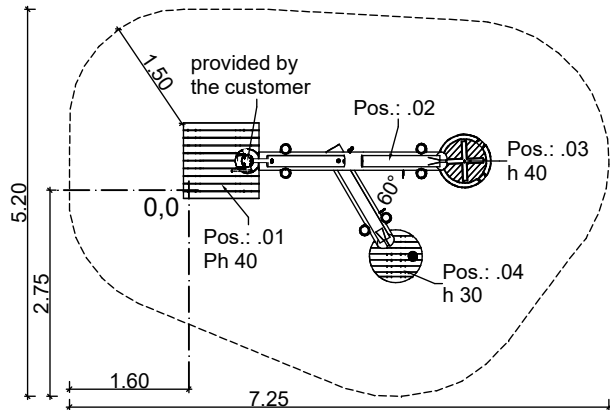

foundation plan  
check measurements  
on building site

because of crooked trees different  
measures are possible

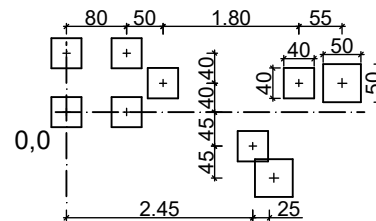

foundation detail  
without scale

minimum soil class III; check compression  
or make foundation bigger

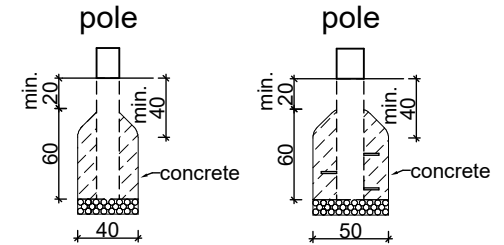

**wood certification: see order**

The minimum area must be free of obstacles to/on which the user can during his movement unexpectedly fall or crash. Hard and sharp objects, as well as trip-surfaces count as obstacles.

project:	Water play unit "Havel"	scale:	A4; 1:100	page:	1/1
address:		date:	29.08.2023	fall height:	max. 0,40m
advisor:		editor:	F. Becker	 Master enterprice of woodcarving handicrafts © SIK-Holzgestaltungs GmbH	
article ID:	8.05.72	order no.:			
project ID:		drawing type:	assembly		

# ASSEMBLING INSTRUCTION

## 8.05.72 Water Play Unit "Havel"

### Scope of delivery

Amount	Denomination	Measure
1	<b>tree fork (constructed made of 2 gutters approach lateral right)</b>	120 kg
1	platform for water pump	100 kg
1	mixing table with roundabout distributor	50 kg
1	mixing table with sieve	45 kg
<b>sum</b>	<b>approx</b>	<b>315 kg</b>

All weights are approximate. The heaviest component is highlighted in bold.

### Tools

- spade, shovel, tape measure, spirit level, hammer
- socket wrench 17 / 19 mm, screwdriver with insert Torx Bit (TX 10-30)
- 2 persons (2 installers at 9 h), wheel loader with palette fork, possibly mini excavators
- approx. concrete 0.7 m<sup>3</sup> C 20/25

### Assembling

- First, the playing surface (security area) should be measured, set the point (height) and the start point (platform) can be determined.
- Determine the foundation positions according to plan. **Measures are to be checked by the client/customer, because of the natural growth forms of the wood.**
- Digging holes, depending on the section for the unit and bringing in gravel shift 10 cm in order to prevent stagnant moisture.
- Lift the platform, tree fork and tables one after another into the prepared holes to adjust by means of spirit level and make them solid.
- **Installation-hole (cut) on the stand posts are to consider.**

**Attention:** if not adequately secured play towers or attachment parts may be tipping!

- It has to be on a slight slope to water storage in the course of the gutter. Before creating the foundations a sample stream is carried out in order to make any corrections.
- After everything is assembled and aligned, the foundation according to the drawing can be properly completed.
- After 3-5 days of curing time, tightening all screw joints which fill game surface again and clear the game surface for playing.
- Transportation braces and installation damage are to be removed after installation on site, grind and paint damaged areas.
- **Notice:** concrete needs about 28 days in order completely to harden.

### Security guidelines

During the assembly and transport to the site or attachment parts must play towers always be adequately protected, either through technology or through attached transportation braces.

***You take the case room for the game device from the installation drawing please.***

Near game devices with a free drop height of more than 600 mm and/or an enforce move after **EN 1176-1:2008 4.2.8.5.2, bzw. EN 1177** must be shock-absorbing playground grounds in the entire strike field. (Than are not valid in a shock-absorbing way bricks, stones, concrete, bitumen and wood).

### Preventive maintenance instructions

The device is to be checked 2 weeks after his arrangement for flawless function. Basically attention should be paid in this case to screw joints and the stability.

The game device should once in the week of a visual routine – inspection as soon as once in the month a functional inspection is subjected to. Once per year the main inspection is to be carried out.

We recommend, to dig the device freely once in the year up to the foundations and to colour the equipment pieces with a solvent free herb varnish.

**(see also check list regular maintenance and the tips in the catalogue of the SIK-Holzgestaltungs GmbH)**

Rev. 02.2016	Page 1 von 1	MASTER ENTERPRISE OF WOODCARVING HANDICRAFTS / © SIK-Holzgestaltungs GmbH	
FURTHER INFORMATION: SIK-HOLZGESTALTUNGS GMBH, LANGENLIPSDORF 54 A, D-14913 NIEDERGÖRSDORF; +49(0)33742.799 0; WWW.SIK-HOLZ.DE; INFO@SIK-HOLZ.DE			