

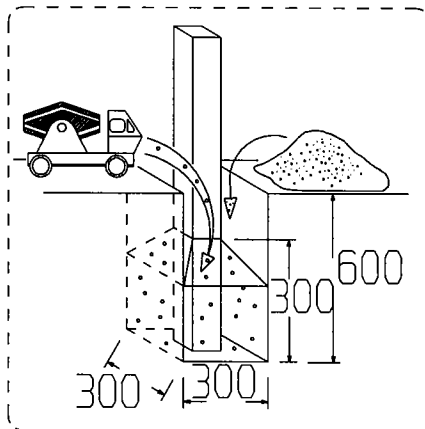

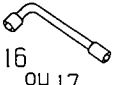



U 4103-T





 16 ou 17			
			M ³

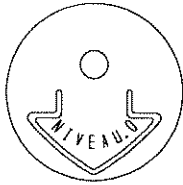
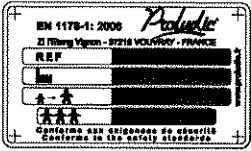

LA000

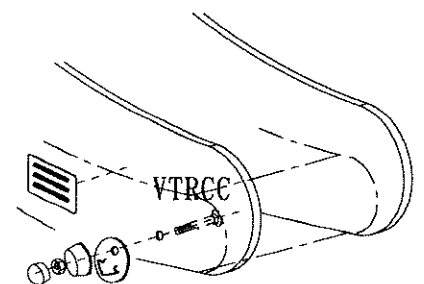
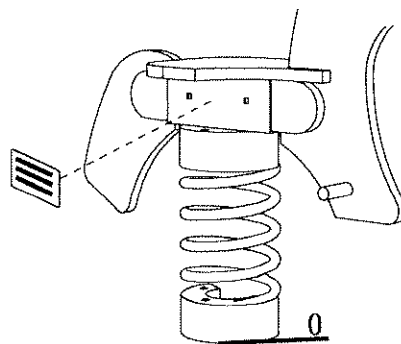
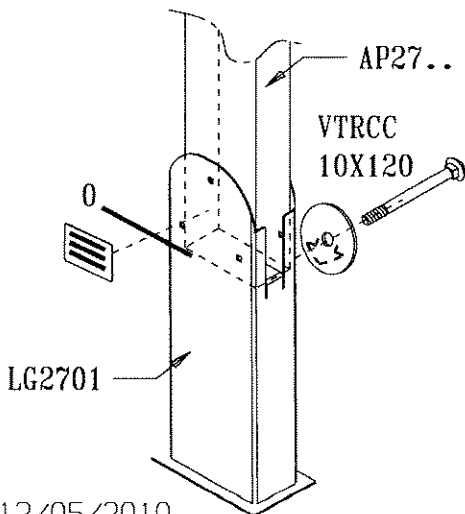
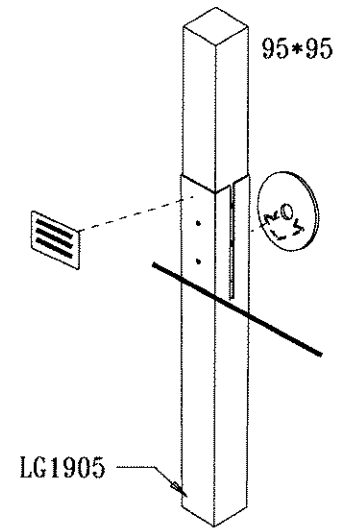
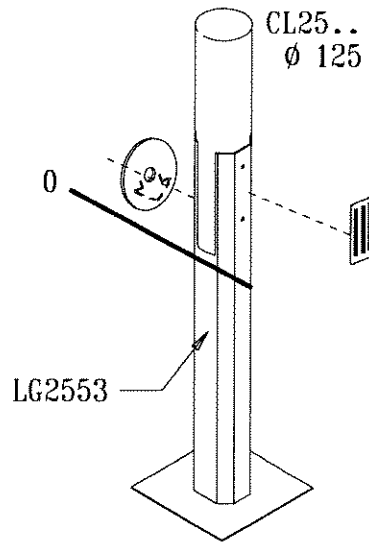
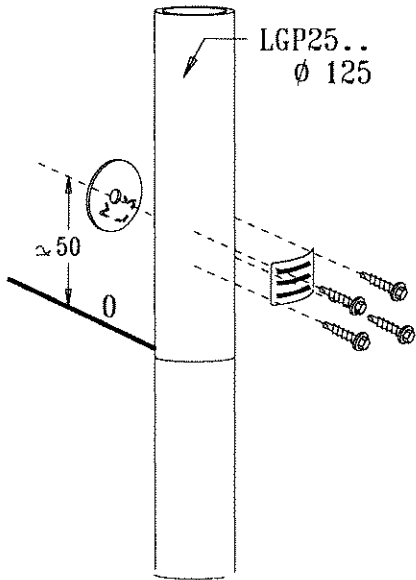
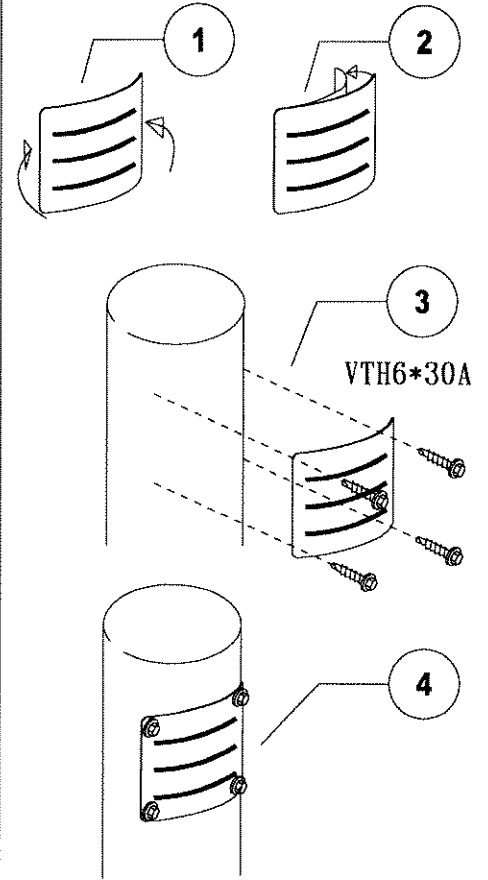
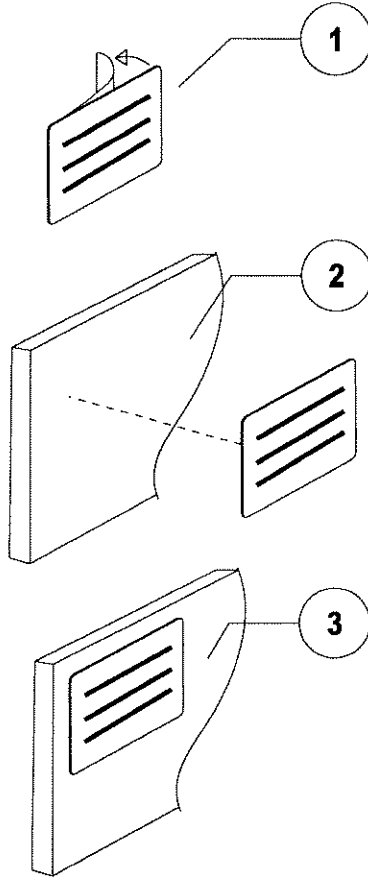
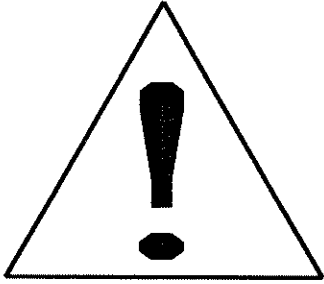
MI0002

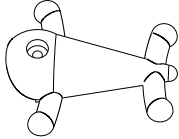
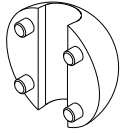
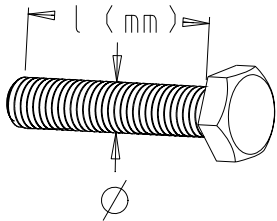
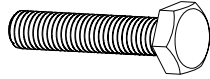

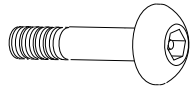
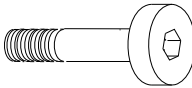
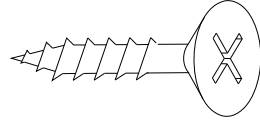
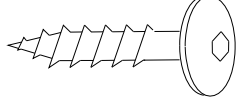
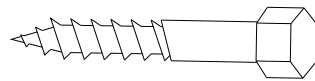
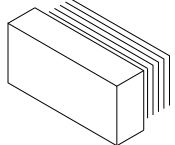
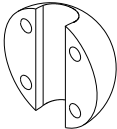
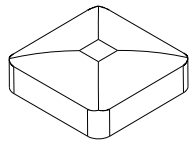
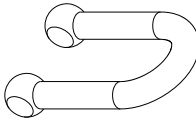
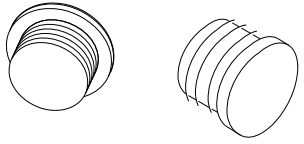
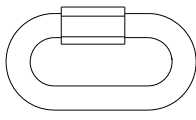
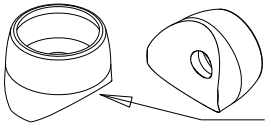
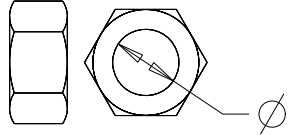
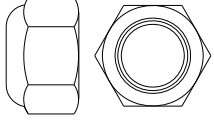
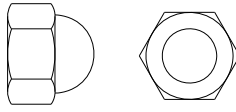
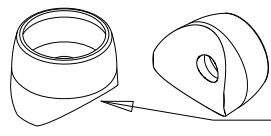
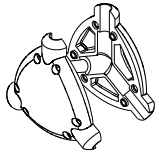
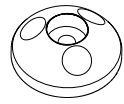
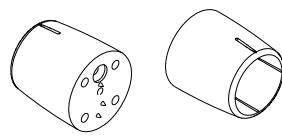
	M100VJ		MI6A	 <p>VTH 10 x 120</p> <p>Ø</p> <p>l (mm)</p>  <p>VTH</p>  <p>VTRCC</p>  <p>VCBHC</p>  <p>VBTR</p>  <p>VWT</p>  <p>VBT</p>  <p>VTF</p>
	M4080		MI6B	
	MI0001N		RMANI06	
	M42		RMARA06	
	MI2503 Ø 40	 <p>VECMØ nut</p>  <p>VEFMØ locknut</p>  <p>VEBMØ blind nut</p>		
	MI2701 Ø 60			
	MI28N			
	MI323J			
	MI5C			