



Monteringsanvisning



Assembly Instructions



Monteringsanvisning

Produkt nr. / Product no. / Produkt nr.

50-151-760

Ordr. nr. _____

Dato. _____

Sign. _____

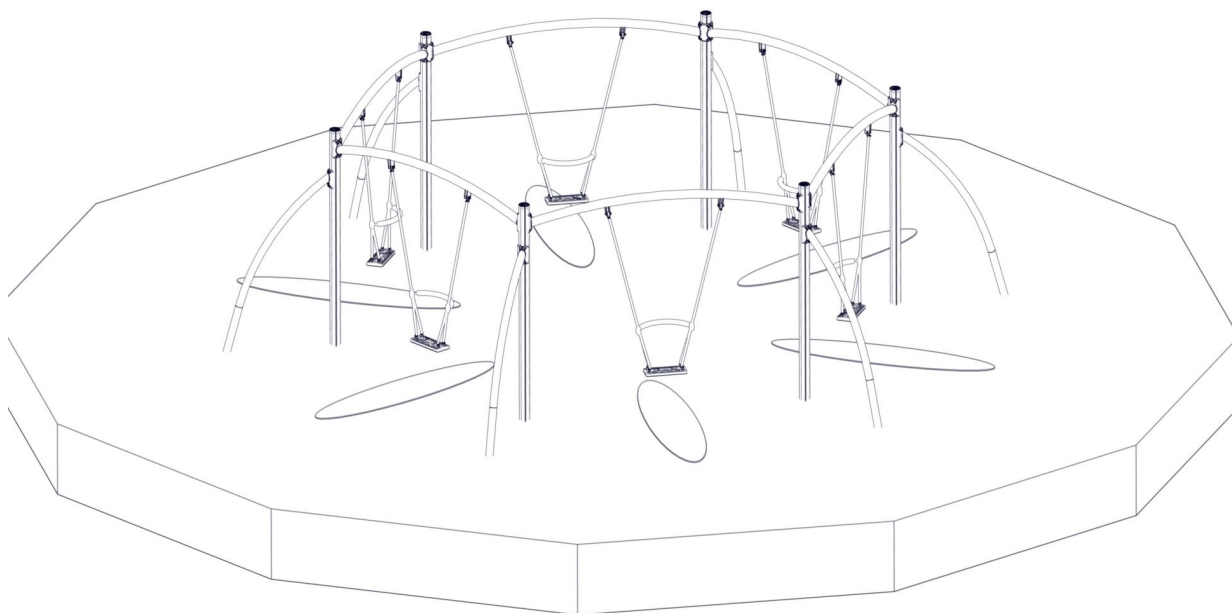

sove

Søve AS
3830 Ulefoss - Norway
Tlf: +47 35 94 65 65
www.sove.no



Søve AB
EA Rosengrensgatan 32
421 31 Västra Frölunda
Phone: +46 (0)31 773 97 00
www.sove.se

Monteringstips / Assembly Advice / Monteringsstips**N**

- Les monteringsanvisningen nøye før montering.
- Monter elementene i rekkefølgen som vist.
- Boltene bør ikke skrues for hardt til før alt er montert, vatret og loddet. Skru så boltene til.
- NB! Ved bruk av drill, kan boltene ryke.
- På grunn av at solen kan gjøre rutsjeplaten veldig varm, bør rutsjebanens utløp vende mot nord-øst eller nord-vest.
- Er lekeutstyret plassert i naturlige ferdselstraséer må området sikres mot gjennomgang.
- Innspringningshinder bør vurderes rundt lekeapparater hvor det er stor bevegelse, f.eks. ved huskestativ.
- Det bør være fritt innsyn til lekeutstyr som er beregnet for barn under 3 år.

NB! Under monteringsarbeidet må utstyr, som ikke er forankret forsvarlig i bakken, sikres slik at det ikke velte.

Området må avstenges under montering av apparatene med sperrebånd eller lignende.

EN

- Read the instruction carefully before assembling the play unit..
- Assemble the components in the sequence shown in these instructions.
- Fixings must not be fully tightened during assembly. Before casting the foundations, the structure must be level and plumb, at which point all fixings are tightened.
- PS! If use of drill, the bolts may be wrecked.
- Avoid positioning the slide facing due south because of overheating – ideal positions are facing north-east or north-west.
- Secure the construction-area to prevent people from walking through it.
- Consider installing barriers around play-equipment which gives rise to a lot of activity – i.e.swings.
- Ensure that clear vision is possible across the play area so that supervision is possible from any position, particularly where children under 3 years of age will be playing.

NB! During assembly of the equipment, ensure that all structures are securely propped, especially when left overnight. Also ensure that equipment is supported whilst concrete foundations are setting and enclose the area securely to prevent access.







Monteringstips / Assembly Advice / Monteringsstips**S**

- Läs monteringsanvisningen noga före montering.
 - Montera delarna i den ordningen som anvisas
 - Skruvarna bör inte skruvas för hårt tills allt är monterat, i våg och lodat.
- OBS! Används elektrisk skruvdragare, kan bulten gå sönder. Hårdra därför manuellt!
- Solen kan göra att rutchbanan blir väldigt varm. Banans nedfart rekommenderas att vändas i norrlig riktning
 - Om lekplatsen placeras vid en gångväg mm bör området säkras mot genomfart av gående och cyklister.
 - Insprängningshinder bör placeras runt lekutrustning med stor rörelse, t ex, gungställning.
 - Det bör vara fri insyn till lekutrustning beräknat till barn under 3 år.

OBS! Under monteringsarbete bör utrustningen som inte ska förankras i marken, ställs så att den inte kan välta.

Området måste spärras när lekutrustningen byggs upp, med avspärningsband eller liknande.

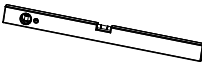
Nødvendig verktøy / Tools required / Nödvändiga verktyg

<p>(N)</p> <p>(UK)</p> <p>(S)</p>	<p>(A)</p> 	<p>(B)</p>  <p>Torx Nr 45 High quality</p>	<p>(C)</p>  <p>13</p>	<p>(D)</p> 	<p>(E)</p> 
		<p>Metermål</p> <p>Metric measure</p> <p>Tumstoc</p> 		<p>Merkebånd</p> <p>Mark ribbon</p> <p>Märkeband</p> 	

Nødvendig antall personer / Number of persons required / Lämpligt antal personer

<p>(N)</p> <p>(UK)</p> <p>(S)</p>	
-----------------------------------	---

Anbefalt arealbehov ved montering / Recommended working space / Rekommenderad arealbehov vid montering

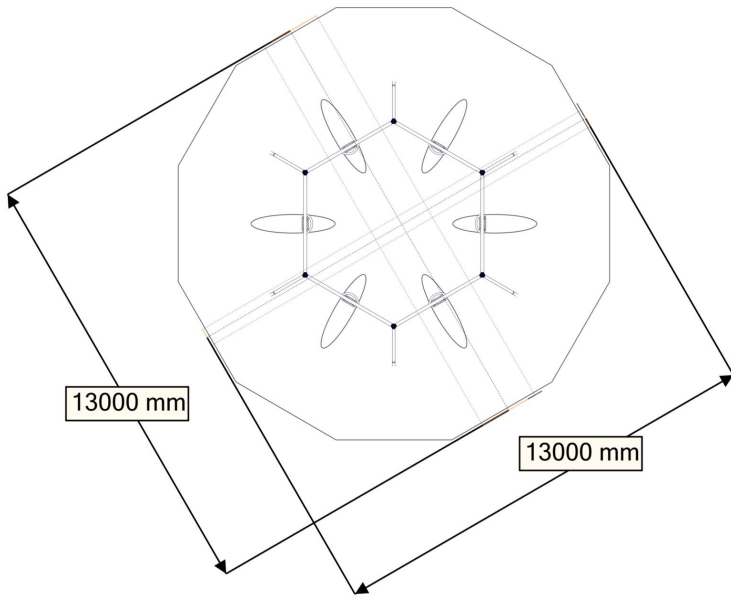
<p>(N)</p> <p>(UK)</p> <p>(S)</p>	
-----------------------------------	--

Sikkerhetszone / Safety zone / Säkerhetszon

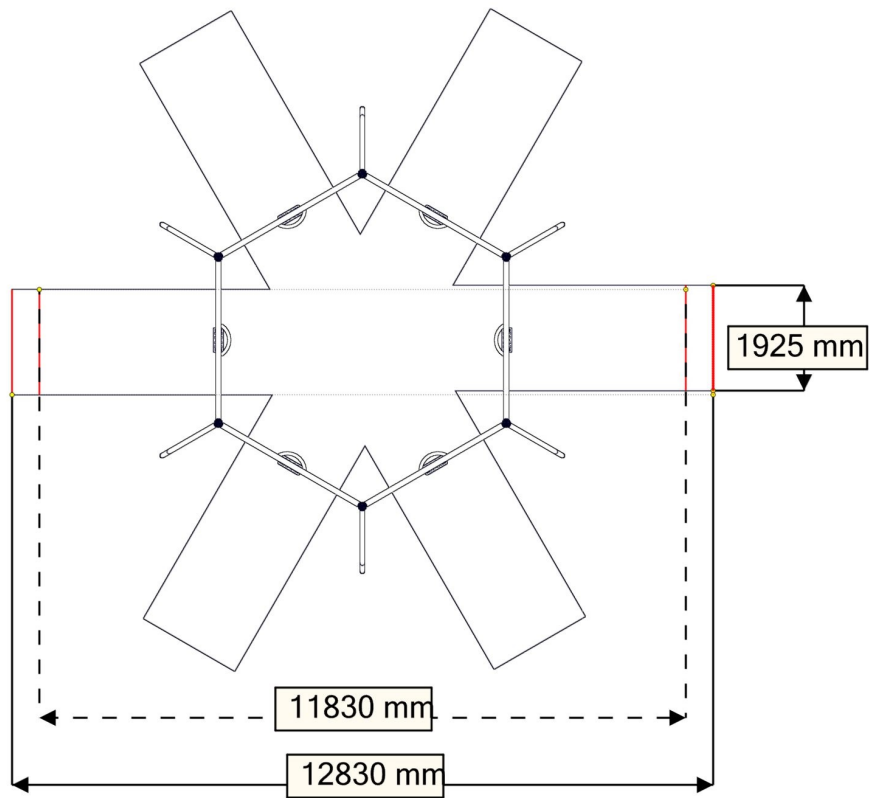

Fallhöjder / Free height of fall / Fallhöjder

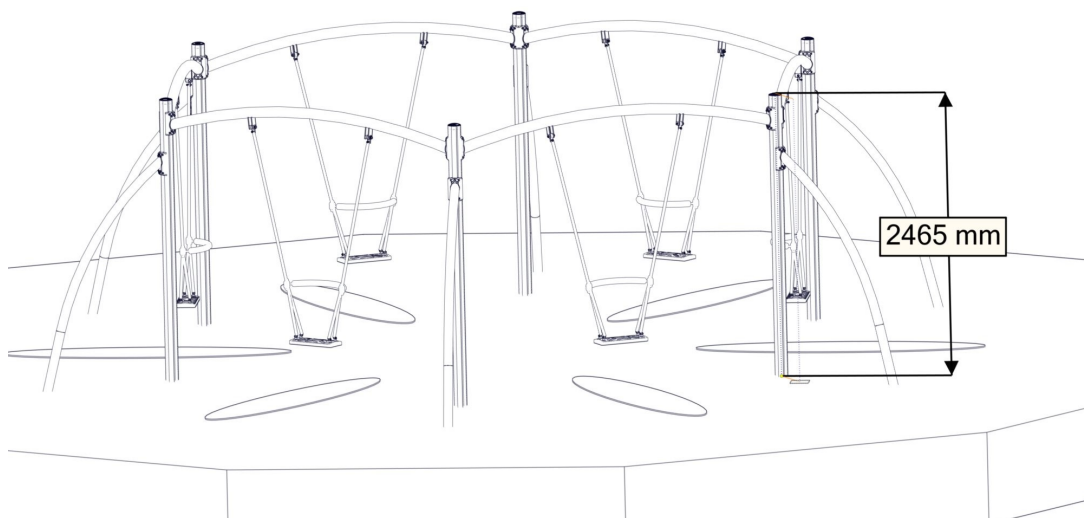

Plassering forankring/ground plan/ placering av förankringar

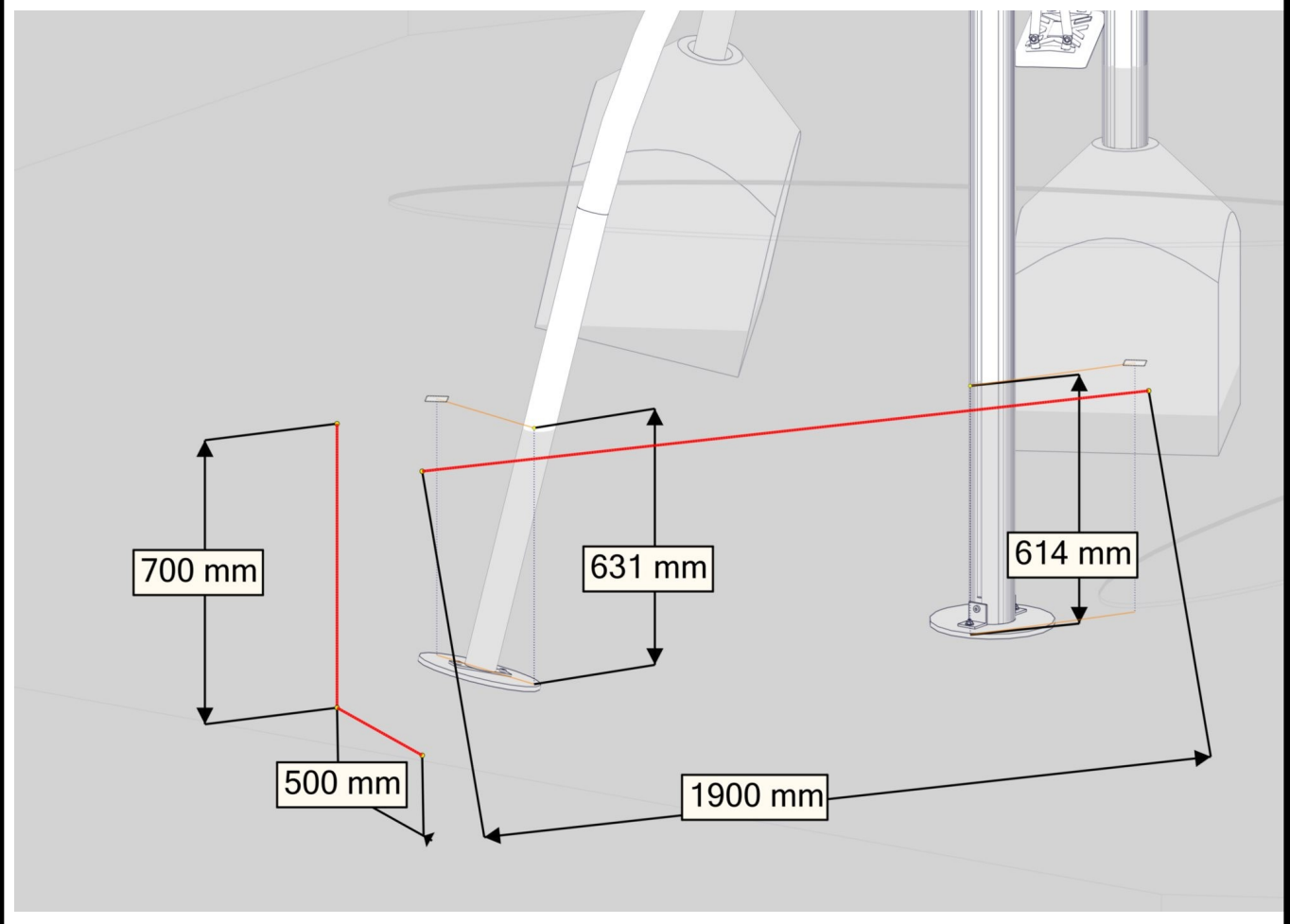
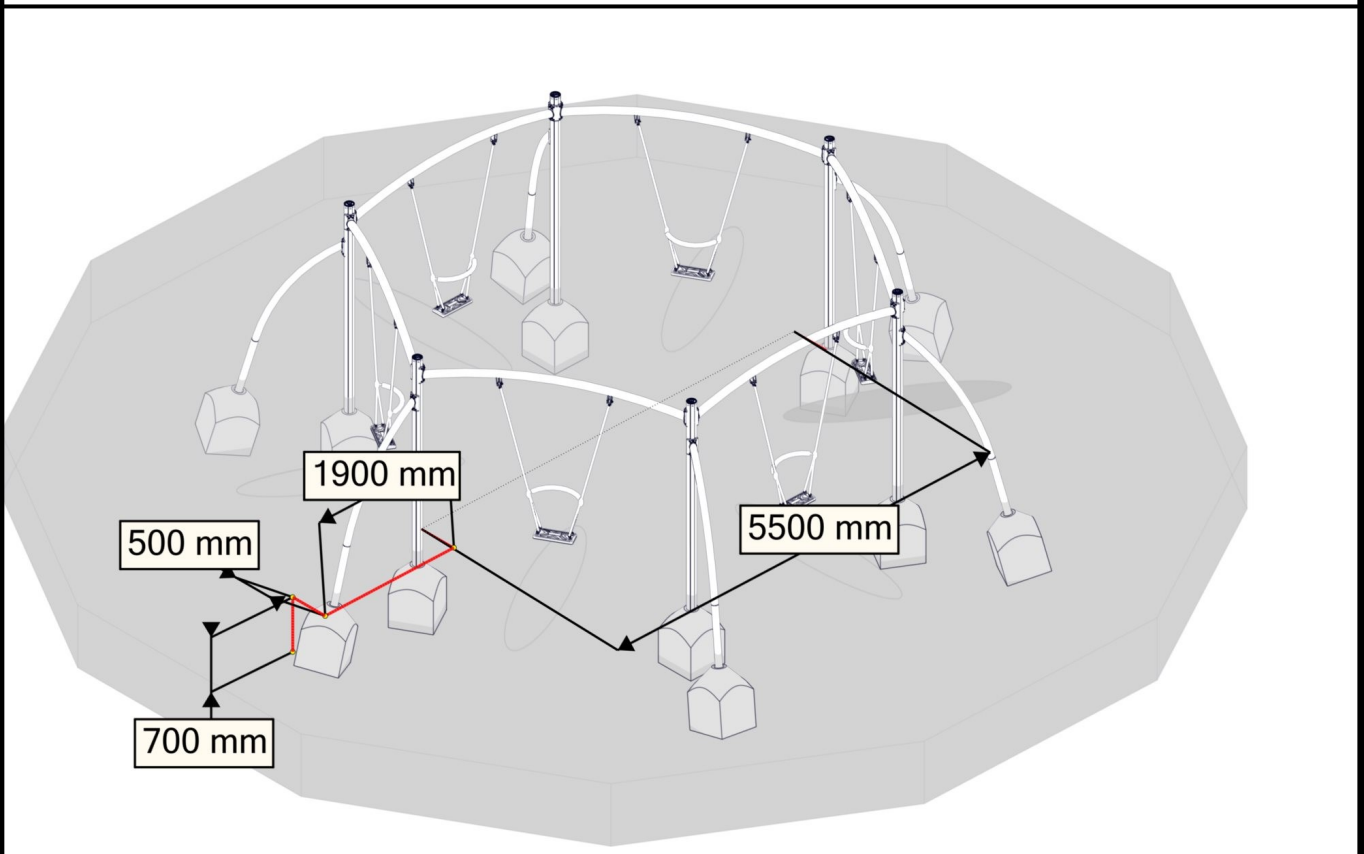

Fundamentering med betong // Foundation concrete // Förankring med betong

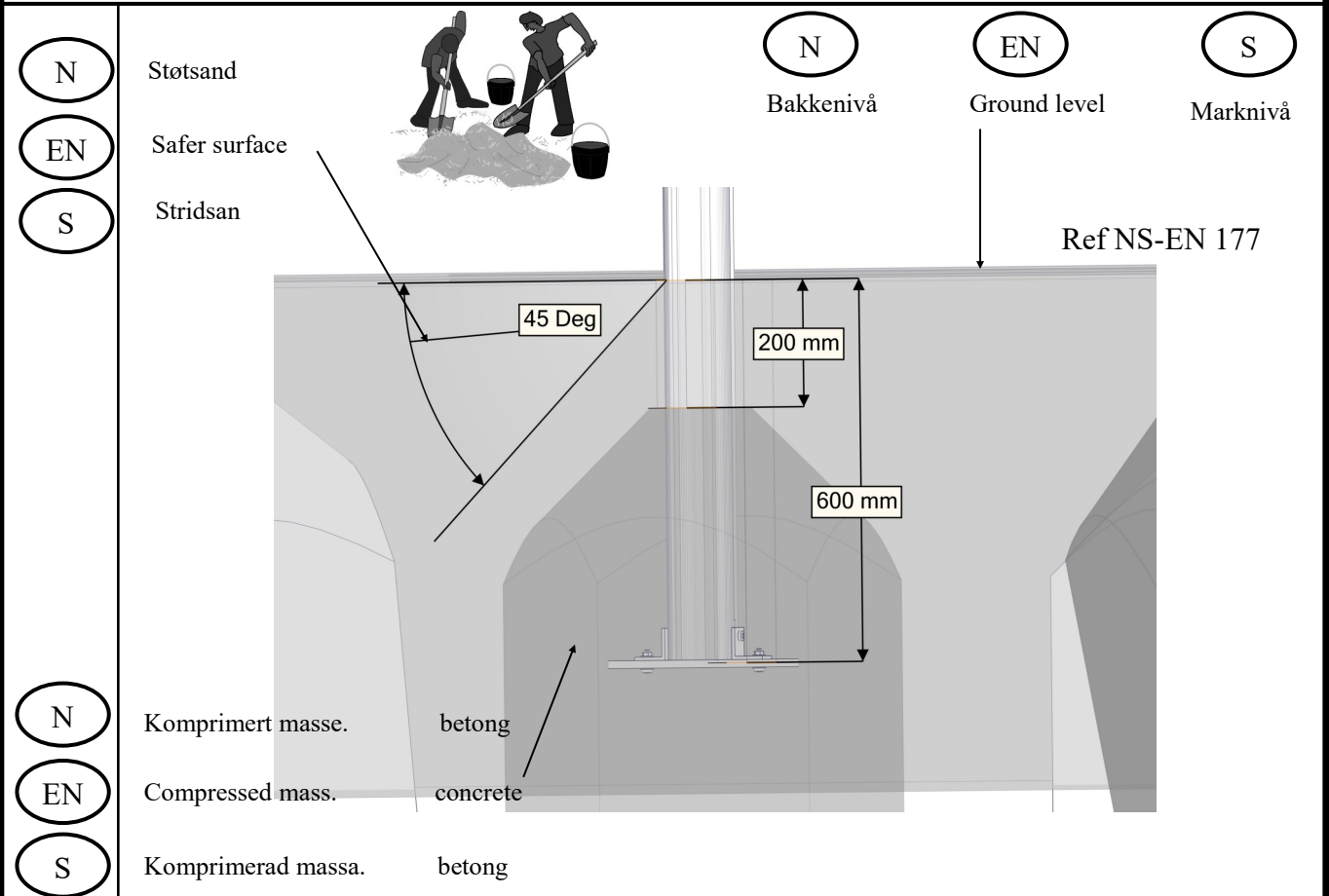



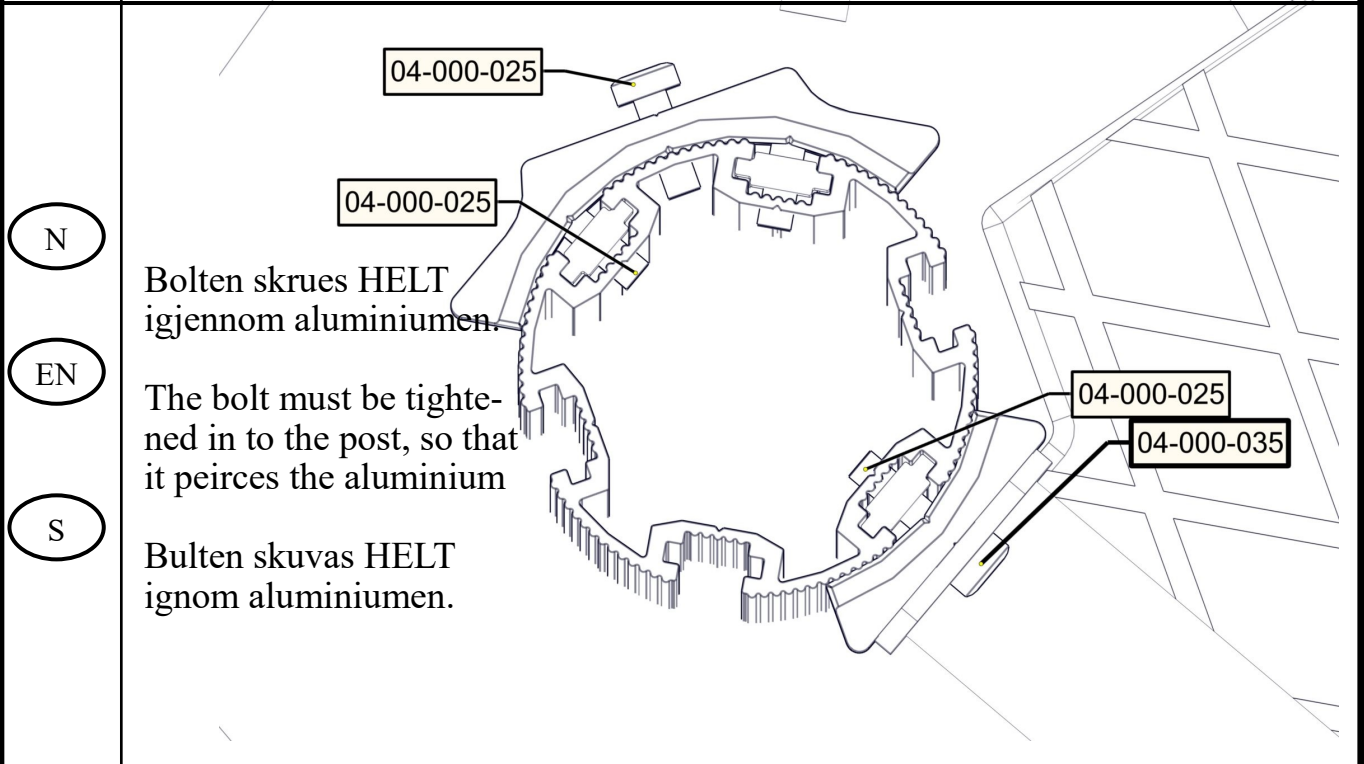



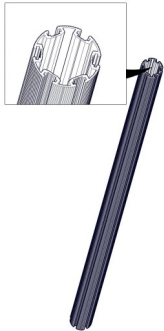

(N)	Alle mål er oppgitt i millimeter
(EN)	Scale measured in mm
(S)	Alla mått är i millimeter.

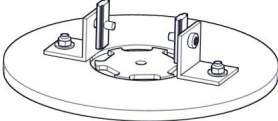
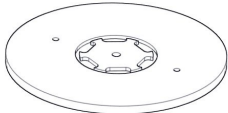









Boltepakker for / Boltpackage for / Bultpaket för

Sign. _____

Stolpe 6SP_110		Navn	Artnr/dimensjon	Ant	Lev
		Stolpe L=3150 600-2550	07-100-403	6	
Stolpe end		Navn	Artnr/dimensjon	Ant	Lev
		Stopl end	04-400-100	6	
Fundament	Ant= 6	Navn	Artnr/dimensjon	Ant	Lev
		Funplate (1)	07-400-011	6	
		Vinkel 50x50x4 11mm (2)	04-070-050	12	
		Brikke 50 (2)	04-060-050	12	
		Torx M8x25 (2) Torx M8x30 (2)	04-000-025 04-000-030	12 12	
		Skive M8 (4)	04-055-008	24	
		Mutter M8 (2)	04-040-008	12	

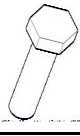
Boltepakker for / Boltpackage for / Bultpaket för





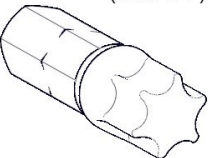
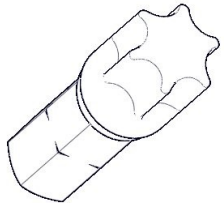







Sign. _____

Støttebein 07-200-088	Ant= 6	Navn	Artnr/dimensjon	Ant	Lev
		Støttebein	07-200-088 (1)	6	
		Brikke 200_2T	04-060-200(2)	12	
		30Gr_200_Huske (1)	07-150-042(Huske)	6	
		M8x20 sekskant(6) Rustfri	04-028-020(2)	36	
		Skive M8 Rustfri	04-058-008(6) 04-055-008(2)	36 12	
		Fundament HPL (1) HOH 120	07-400-105	6	
		Torx M8x25(4) Torx M8x30(2)	04-000-025 04-000-030	24 12	
		Låsemutter M8(2)	04-040-008	12	

Bit Torx TX45 (Drive 1/4")	Ant= 1	Navn	Artnr/dimensjon	Ant	Lev
 Torx TX45 (drive 1/4")		Bit Torx TX45	04-001-045	1	

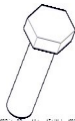
Boltepakker for / Boltpackage for / Bultpaket för

Sign. _____

Produktmerke	Ant= 1	Navn	Artnr/dimensjon	Ant	Lev
		0gr 150_2H (2) Med Produktmerke	????	1	
		Brikke 150_2T(2)	04-060-150	1	
		Torx M8x35 (2)	04-000-035	2	
Overligger Bue 07-200-080	Ant= 6	Navn	Artnr/dimensjon	Ant	Lev
		Overligger_bue	07-200-085(1)	6	
		Brikke 200_2T	04-060-200(4)	24	
		30Gr_200_Huske	07-150-042(Huske)(2)	12	
		Torx M8x25	04-000-025(8)	48	
		Sekskant M8x16 (8) Sekskant M8x25 (4) Rustfritt	04-028-016(8) 04-028-020(4)	48 24	
		Skive M8 Rustfri	04-058-008(12)	72	
Loctite	Ant= 1	Navn	Artnr/dimensjon	Ant	Lev
		Loctite	!!!!	1	

Plassering av forankringer / Ground plan / Placering av förankringar

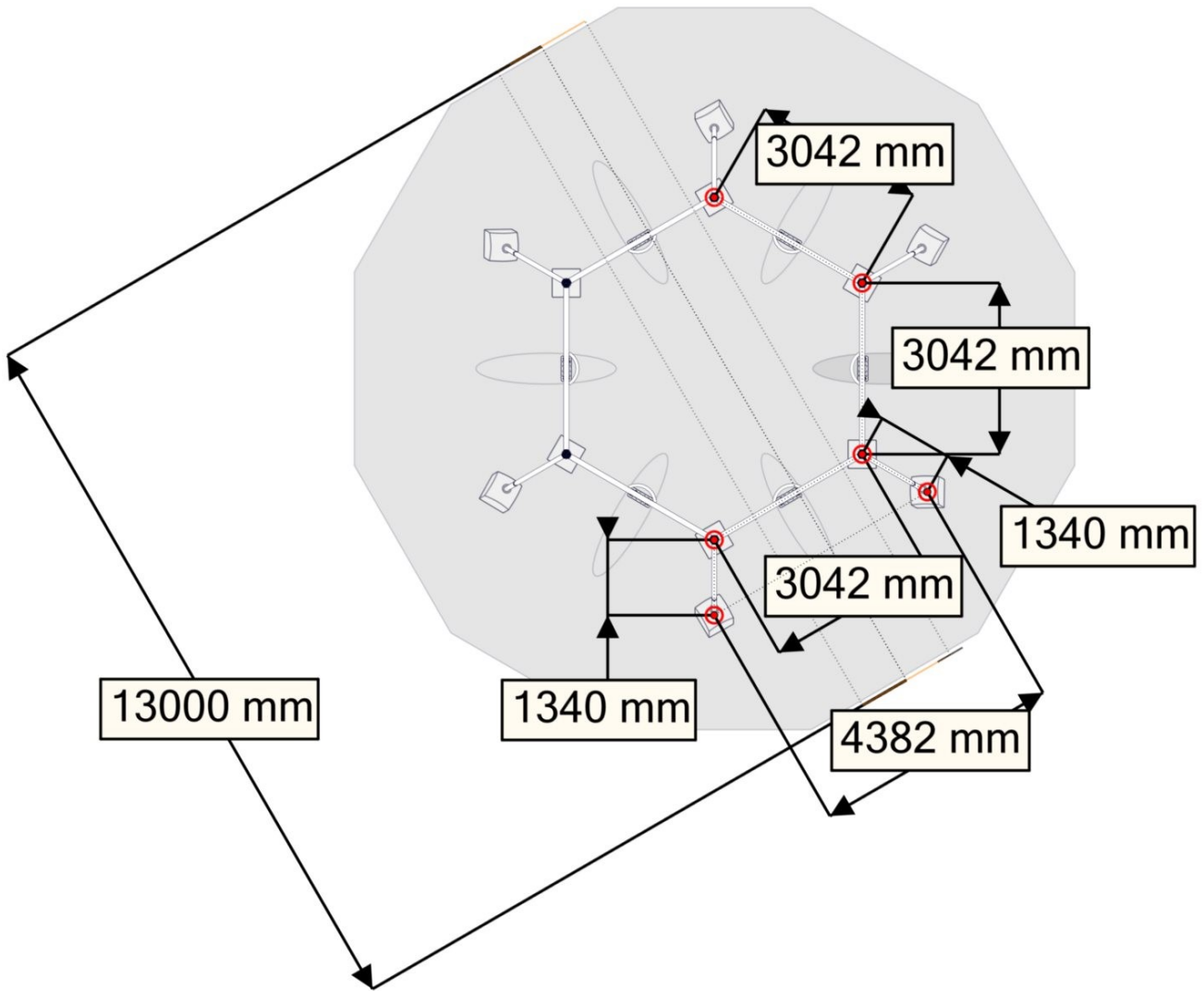

N

UK

S

Scale measured in mm

Alla mått är i millimeter.

6x

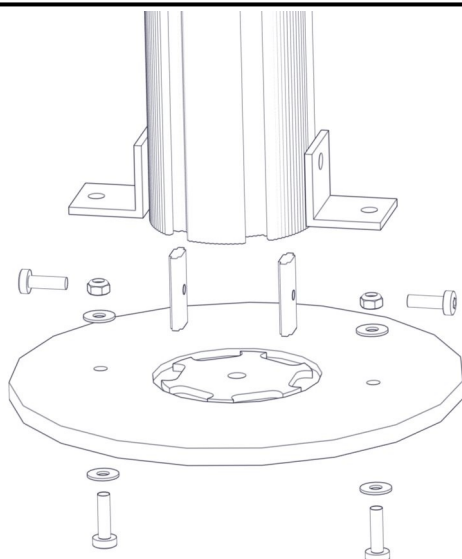

nr	PartName	Artnr	Antall
1	Torx M8x25	04-000-025	2
2	Torx M8x30	04-000-030	2
3	Låsemutter M8	04-040-008	2
4	Skive M8 stor	04-055-008	4
5	Brikke50 1XM8	04-060-050	2
7		07-100-403	1
8	Fundamentplate 1 stolpe	07-400-011	1

6x

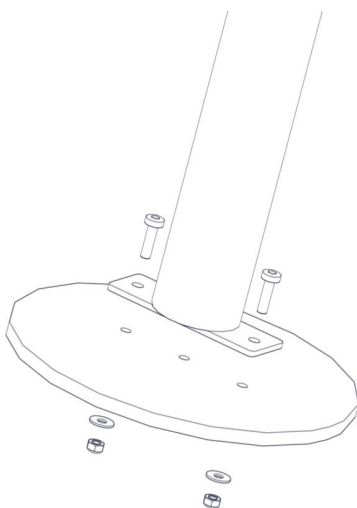

nr	PartName	Artnr	Antall
1	Torx M8x30	04-000-030	2
2	Låsemutter M8	04-040-008	2
3	Skive M8 stor	04-055-008	2
5		07-400-105	1
4	Stottebein huskestativ	07-200-088	1

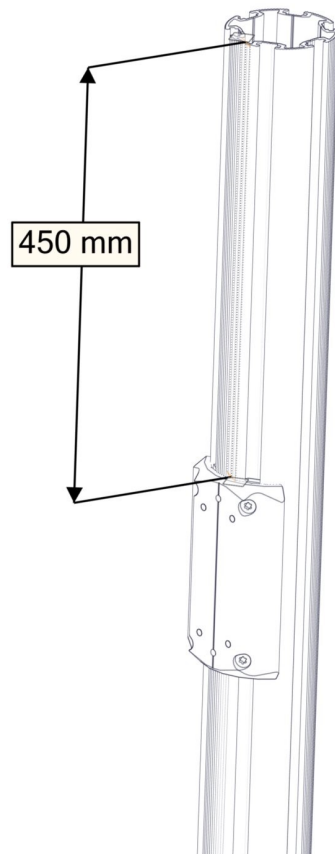

6x

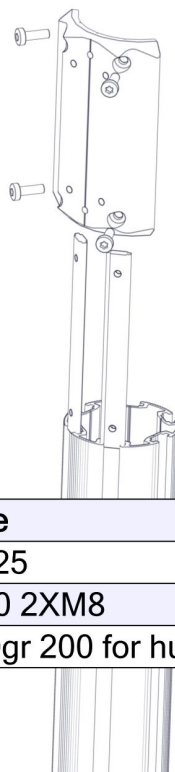

nr	PartName	Artnr	Antall
1	Torx M8x25	04-000-025	4
2	Brikke 200 2XM8	04-060-200	2
3	Beslag 30gr 200 for huske	07-150-042	1

6x

450 mm



nr	PartName	Artnr	Antall
1	Sekskant M8x20	04-028-020	6
2	Skive M8	04-050-008	6
4	Stottebein huskestativ	07-200-088	1

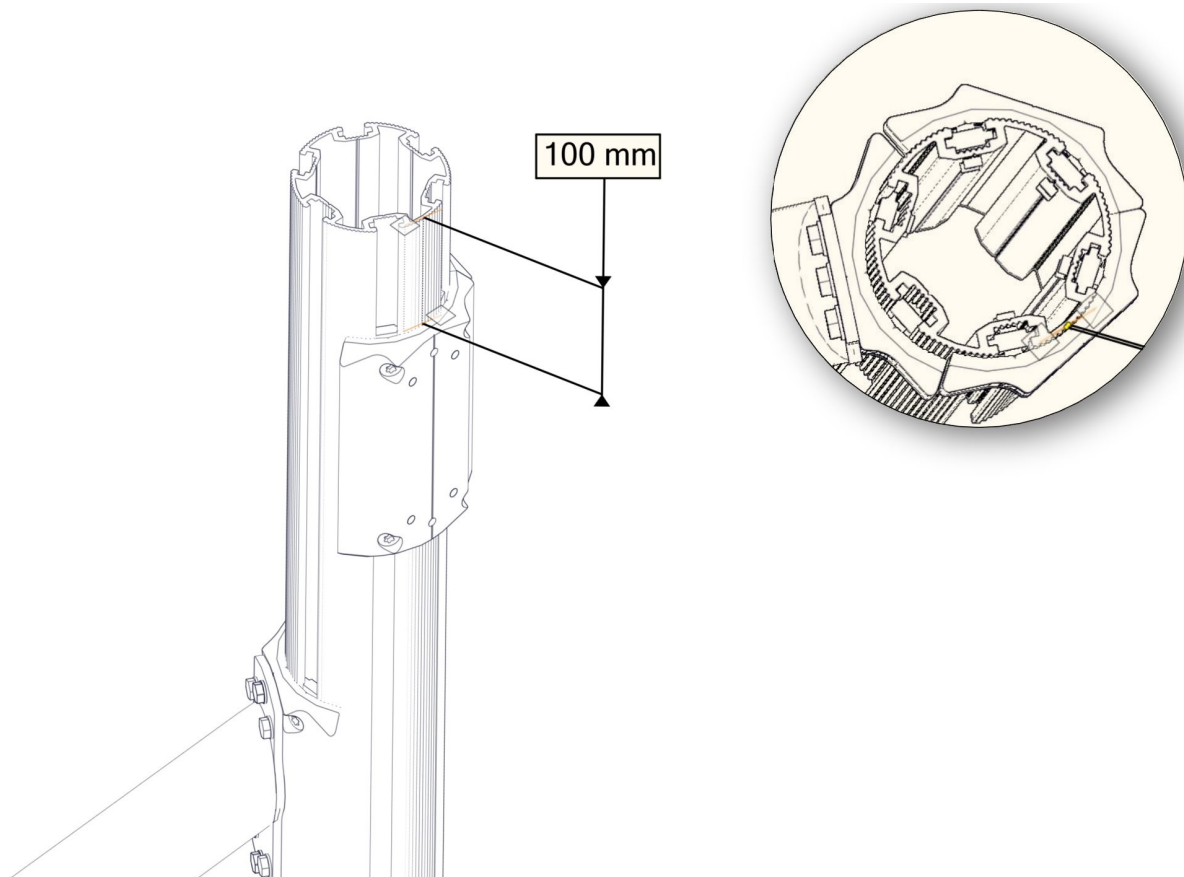

100 mm

6x

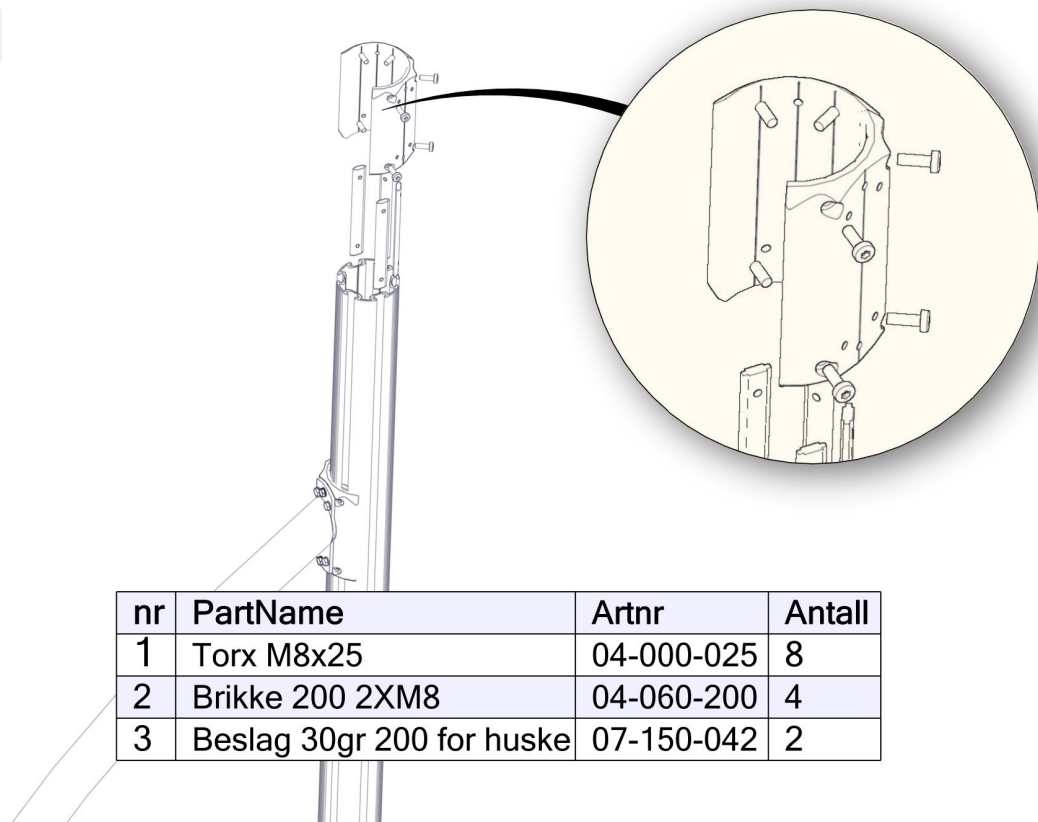

3x

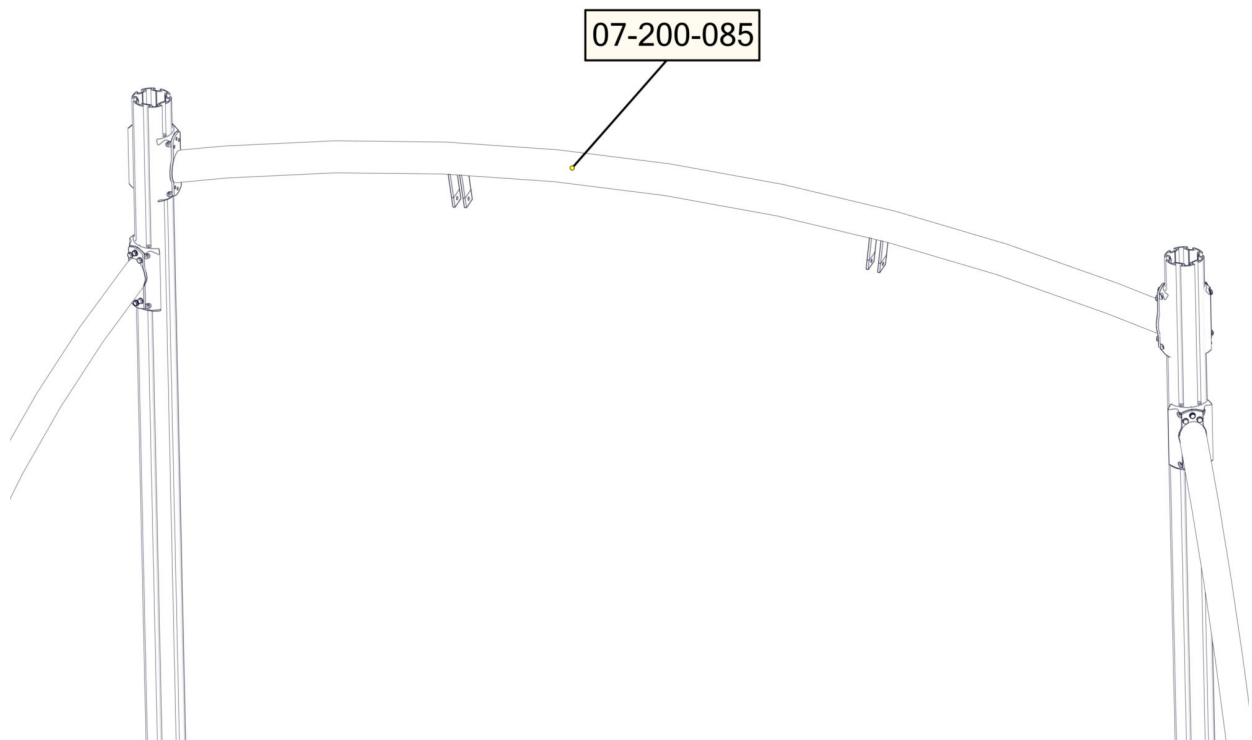

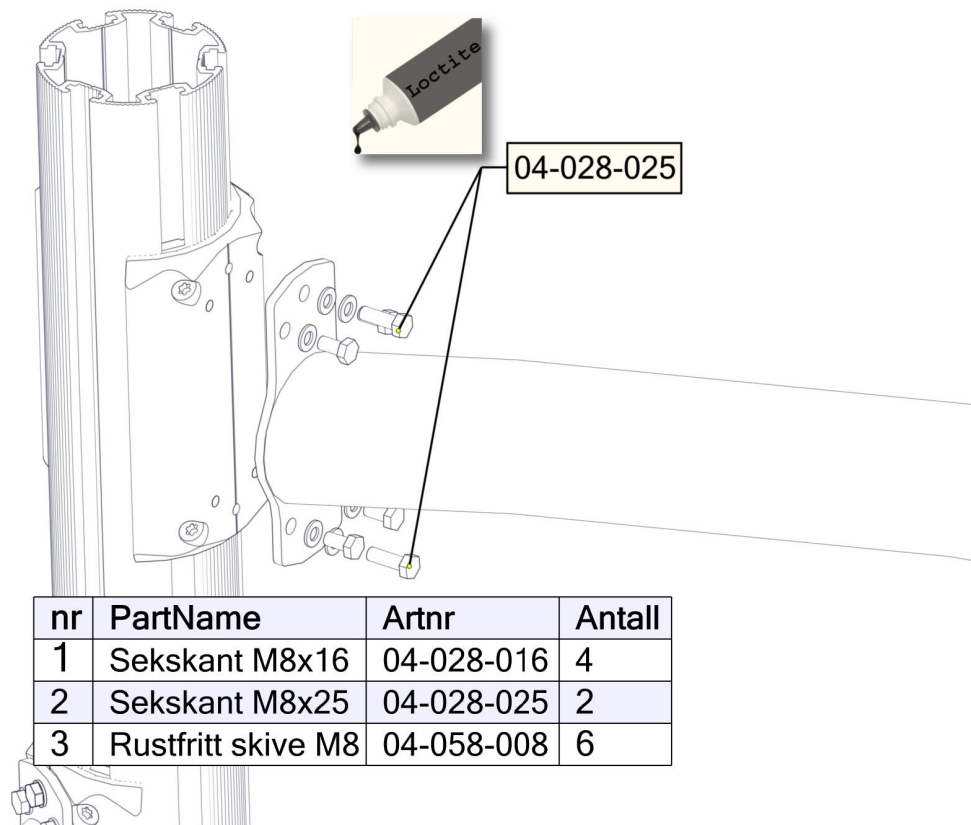

*Pas på at oppheng peker riktig veg!
 *Look out that the mountingbracket is pointing the right way down
 *OBS! Att gungfästena ska hänga lodrätt när överliggaren är rätt monterad

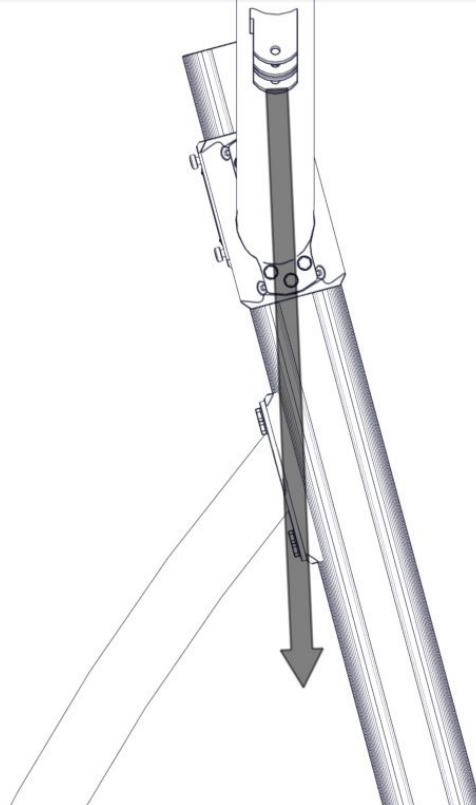

*Pas på at oppheng peker riktig veg!
*Look out that the mountingbracket is pointing the right way down
*OBS! Att gungfästena ska hänga lodrätt när överliggaren är rätt monterad

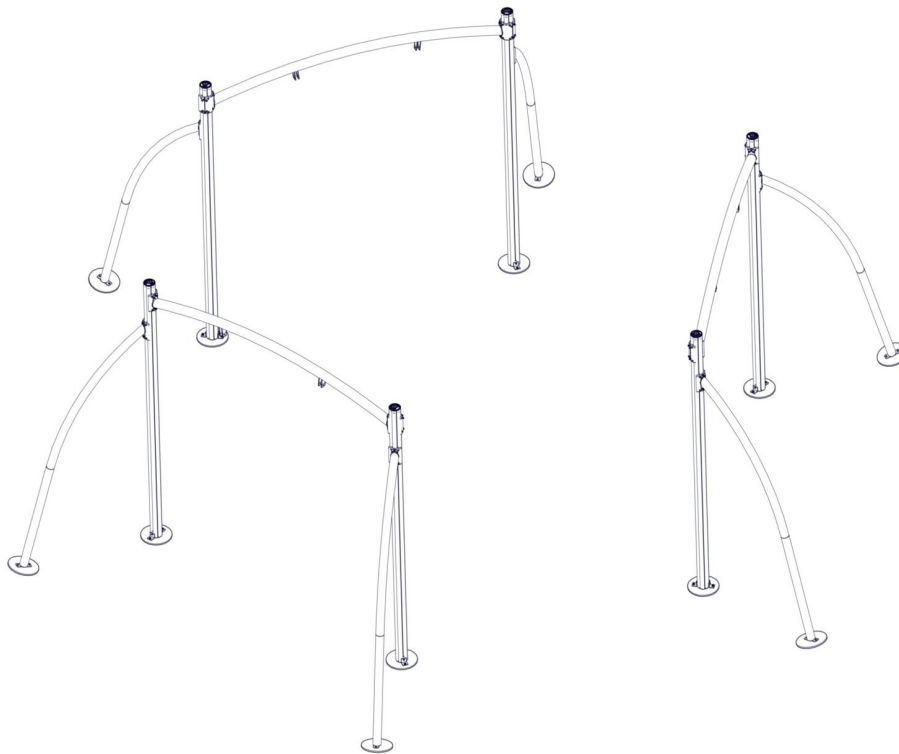
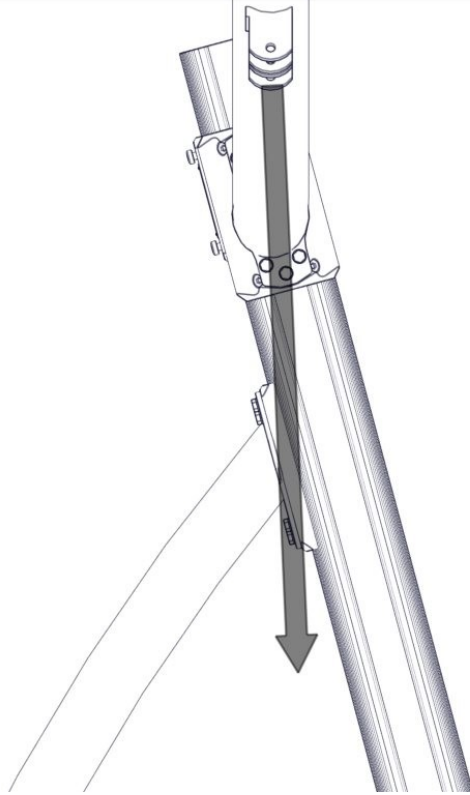

6x

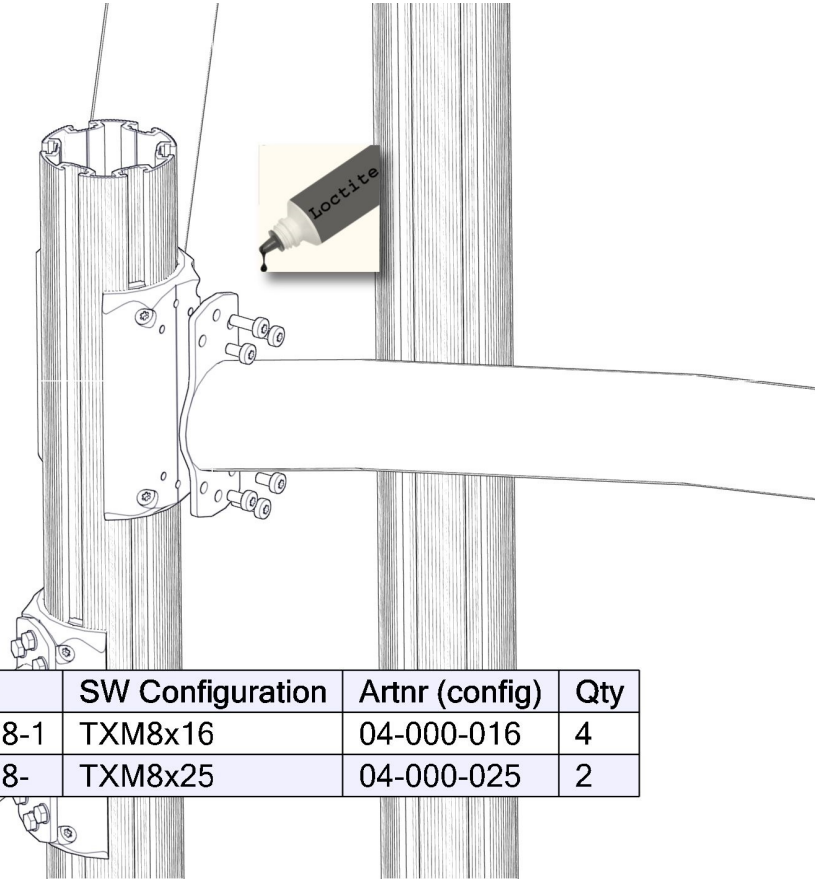

BOM ID	Name	SW Configuration	Artnr (config)	Qty
1	TorxM8-1	TXM8x16	04-000-016	4
2	TorxM8-	TXM8x25	04-000-025	2

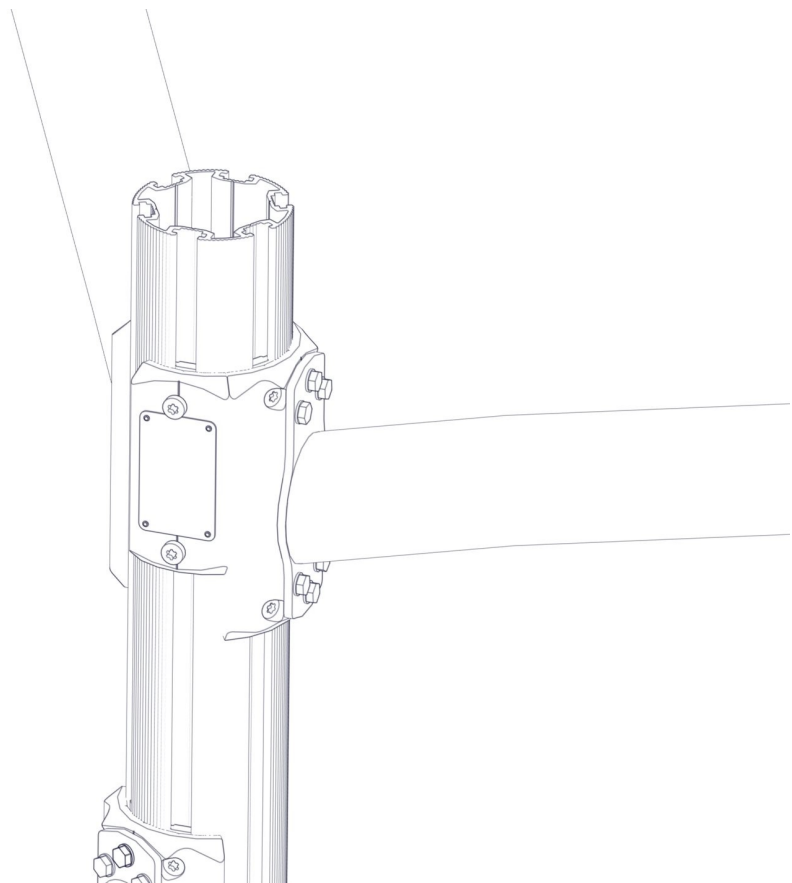

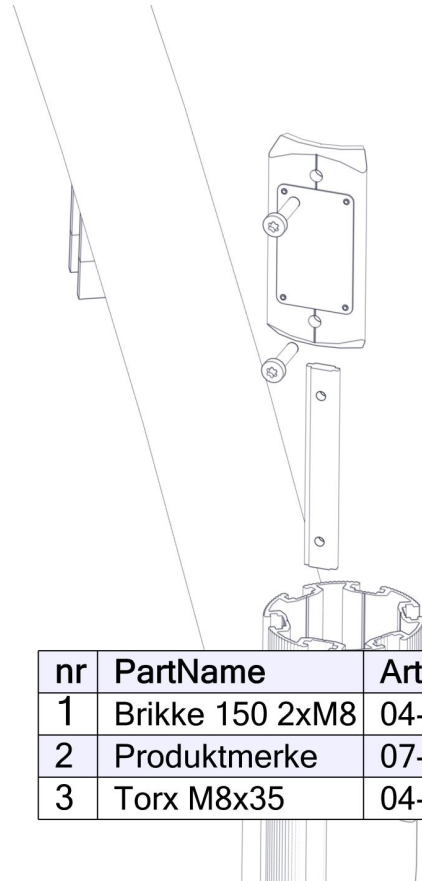

nr	PartName	Artnr	Antall
1	Brikke 150 2xM8	04-060-151	1
2	Produktmerke	07-500-500	1
3	Torx M8x35	04-000-035	2

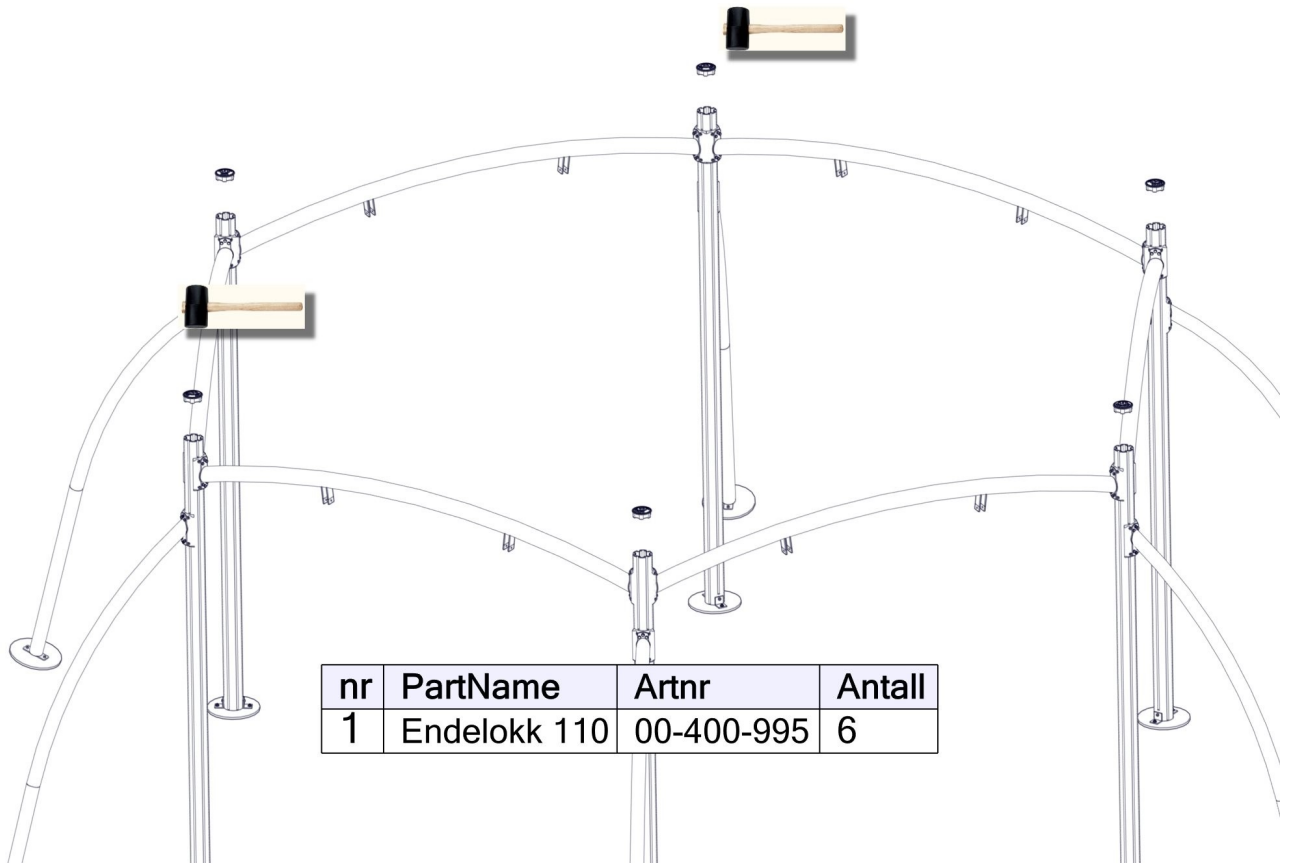



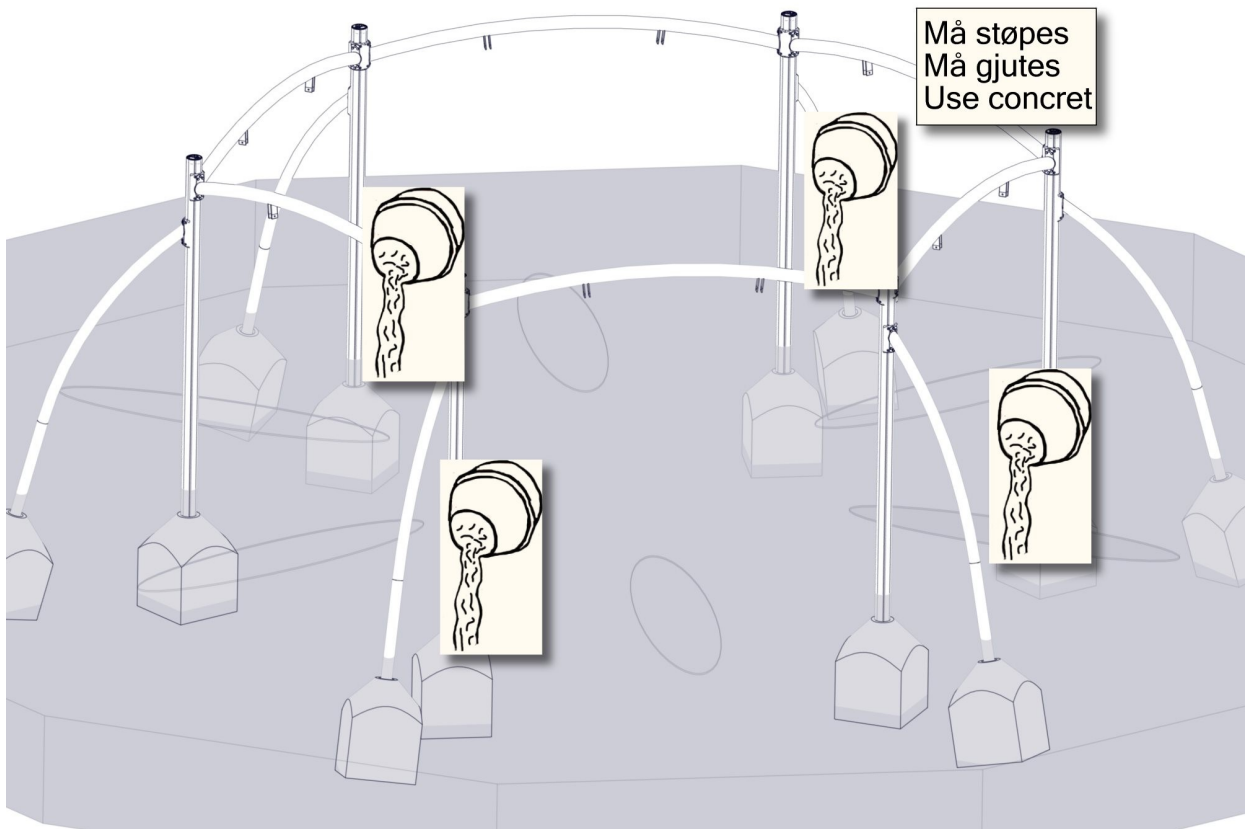







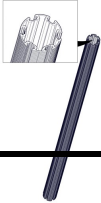

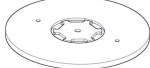

nr	PartName	Artnr	Antall
1	Endelokk 110	00-400-995	6



Før utstyret tas i bruk / Before play begins // Innan lekredskapet tas i bruk	
N	<ul style="list-style-type: none"> ● Påse at fallunderlag er utlagt i henhold til gjeldende regler eller vår anbefaling ● Fjern alle monteringshjelpemidler (rester av betong, planker, paller, plast, og lignende) ● Før utstyret tas i bruk, burde man sjekke at det ikke er fare for at anorakksnorer og lignende som kan hekte seg fast noen steder på lekeapparatet. (Vedlagte snor med dobbe (kneledd) kan brukes til å sjekke at dette er i orden. Se vedlagte veiledning for bruk av denne. Dette gjøres for å oppdage eventuelle feilmonteringer.?) ● NB! Bør stå i 2-3 dager før bruk
EN	<ul style="list-style-type: none"> ● Make sure the area and depth of safer surfacing are according to the current standard, or to the manufacturer's recommendation ● Make sure all tools and surplus materials are removed before play begins ● PS! When complete, allow 2-3 days for the concrete to set before use
S	<ul style="list-style-type: none"> ● Kontrollera att fallunderlag är utlagt enligt gällande regler eller vårt rekommendation ● Ta bort alla monteringshjälpmedel (rester av betong, plankor, pallar, plast och liknande) ● Innan lekredskapet används, kontrollera att anoracksnoddar eller kläder/delar av kläder eller liknande inte kan fastna i några delar på redskapet. (Den bipackade "knävringen" kan man med fördel användas för denna kontroll. ● Detta görs för att upptäcka eventuella felmonteringar.)

Pakkliste / Boltpackage / Packlista

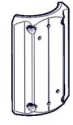
Sign. _____

Bilde		Navn	Artnr/dimensjon	Ant	Lev
	Stolpe 110	Stolpe 110 L=3150 600-2550	07-100-4013	6	
		Endelokk 110	00-400-995	6	
		Fundamentplate	04-400-100	6	
		Støttebein	07-200-088	6	
		Overligger bue	07-200-085	6	
		Produktmerke	07-500-500	1	
		Brikke 50 1xM8 Brikke 200 2xM8 Brikke 150 2xM8	04-060-040 04-060-200 04-060-150	12 36 1	
		Vinkel 50x50x50x5 11mm hull	04-070-050	12	
		Torx M8x25 Torx M8x30 Torx M8x35	04-000-025 04-000-030 04-000-035	84 24 2	
		Låsemutter M8	04-090-108	24	
		Skive M8 Skive M8 Rustfri	04-055-008 04-058-008	36 108	
		Fundamentplate HPL	07-400-105	6	
		Sekskant M8x16 Sekskant M8x20 Sekskant M8x25	04-028-016 04-028-020 04-028-025	48 36 24	
		Beslag 30gr_200 Huske	07-150-042	18	
		Loctite		1	