

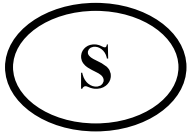

**Monteringsanvisning**



**Assembly Instructions**



**Monteringsanvisning**

Produkt nr. / Product no. / Produkt nr.

**16-500-012**

Ordr. nr. \_\_\_\_\_

Dato. \_\_\_\_\_

Sign. \_\_\_\_\_

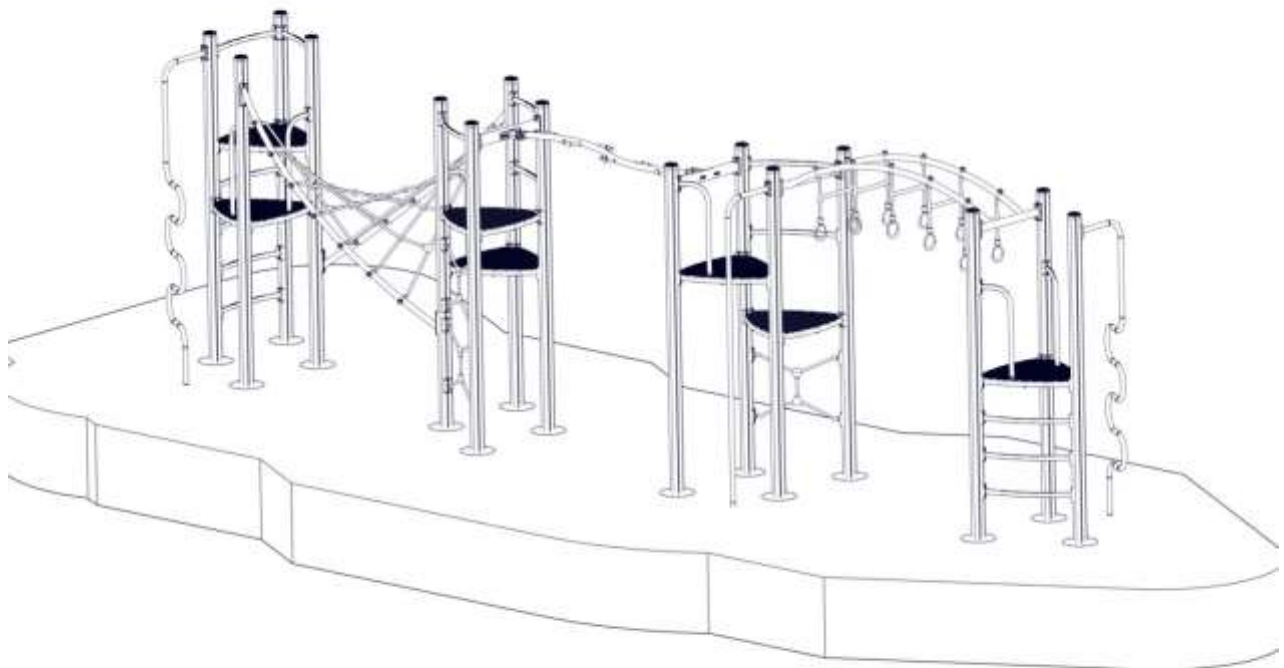

**søve**

Søve AS  
Grønnvoldveien 290  
3830 Ulefoss - Norway  
Tlf: +47 35 94 65 65



**søve**

Søve AB  
EA Rosengrensgatan 32  
421 31 Västra Frölunda  
Phone: +46 (0)31 773 97 00  
[www.sove.se](http://www.sove.se)

## Monteringstips / Assembly Advice / Monteringsstips

**N**

- Les monteringsanvisningen nøye før montering.
- Monter elementene i rekkefølgen som vist.
- Boltene bør ikke skrues for hardt til før alt er montert, vatret og loddet. Skru så boltene til.
- NB! Ved bruk av drill, kan boltene ryke.
- På grunn av at solen kan gjøre rutsjeplatene veldig varme, bør rutsjebanens utløp vende mot nord-øst eller nord-vest.
- Er lekeutstyret plassert i naturlige ferdselstraséer må området sikres mot gjennomgang.
- Innspringningshinder bør vurderes rundt lekeapparater hvor det er stor bevegelse, f.eks. ved huskestativ.
- Det bør være fritt innsyn til lekeutstyr som er beregnet for barn under 3 år.

**NB! Under monteringsarbeidet må utstyr, som ikke er forankret forsvarlig i bakken, sikres slik at det ikke velte.**

**Området må avstenges under montering av apparatene med sperrebånd eller lignende.**

**EN**

- Read the instruction carefully before assembling the play unit..
- Assemble the components in the sequence shown in these instructions.
- Fixings must not be fully tightened during assembly. Before casting the foundations, the structure must be level and plumb, at which point all fixings are tightened.
- PSI If use of drill, the bolts may be wrecked.
- Avoid positioning the slide facing due south because of overheating – ideal positions are facing north-east or north-west.
- Secure the construction-area to prevent people from walking through it.
- Consider installing barriers around play-equipment which gives rise to a lot of activity – i.e.swings.
- Ensure that clear vision is possible across the play area so that supervision is possible from any position, particularly where children under 3 years of age will be playing.

**NB! During assembly of the equipment, ensure that all structures are securely propped, especially when left overnight. Also ensure that equipment is supported whilst concrete foundations are setting and enclose the area securely to prevent access.**

## Monteringstips / Assembly Advice / Monteringsstips

**S**

- Läs monteringsanvisningen noga före montering.
- Montera delarna i den ordningen som anvisas
- Skruvarna bör inte skruvas för hårt tills allt är monterat, i våg och lodat.









OBS! Används elektrisk skruvdragare, kan bulten gå sönder. Hårdra därför manuellt!

- Solen kan göra att rutchbanan blir väldigt varm. Banans nedfart rekommenderas att vändas i norrlig riktning
- Om lekplatsen placeras vid en gångväg mm bör området säkras mot genomfart av gående och cyklister.
- Insprängningshinder bör placeras runt lekutrustning med stor rörelse, t ex, gungställning.
- Det bör vara fri insyn till lekutrustning beräknat till barn under 3 år.

**OBS! Under monteringsarbete bör utrustningen som inte ska förankras i marken, ställs så att den inte kan välta.**

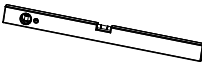
**Området måste spärras när lekutrustningen byggs upp, med avspärrningsband eller liknande.**

**Nødvendig verktøy / Tools required / Nödvändiga verktyg**

<p>(N)</p> <p>(EN)</p> <p>(S)</p>	<p>(A)</p> 	<p>(B)</p> <p>Torx Nr 45 High quality</p> 	<p>(C)</p> <p>13 + 17mm</p> 	<p>(D)</p> 	<p>(E)</p> 
		<p>Metermål Metric measure Tumstock</p> 	<p>16 V</p> 	<p>Merkebånd Mark ribbon Märkeband</p> 	<p>5 mm 6 mm</p> 

**Nødvendig antall personer / Number of persons required / Lämpligt antal personer**



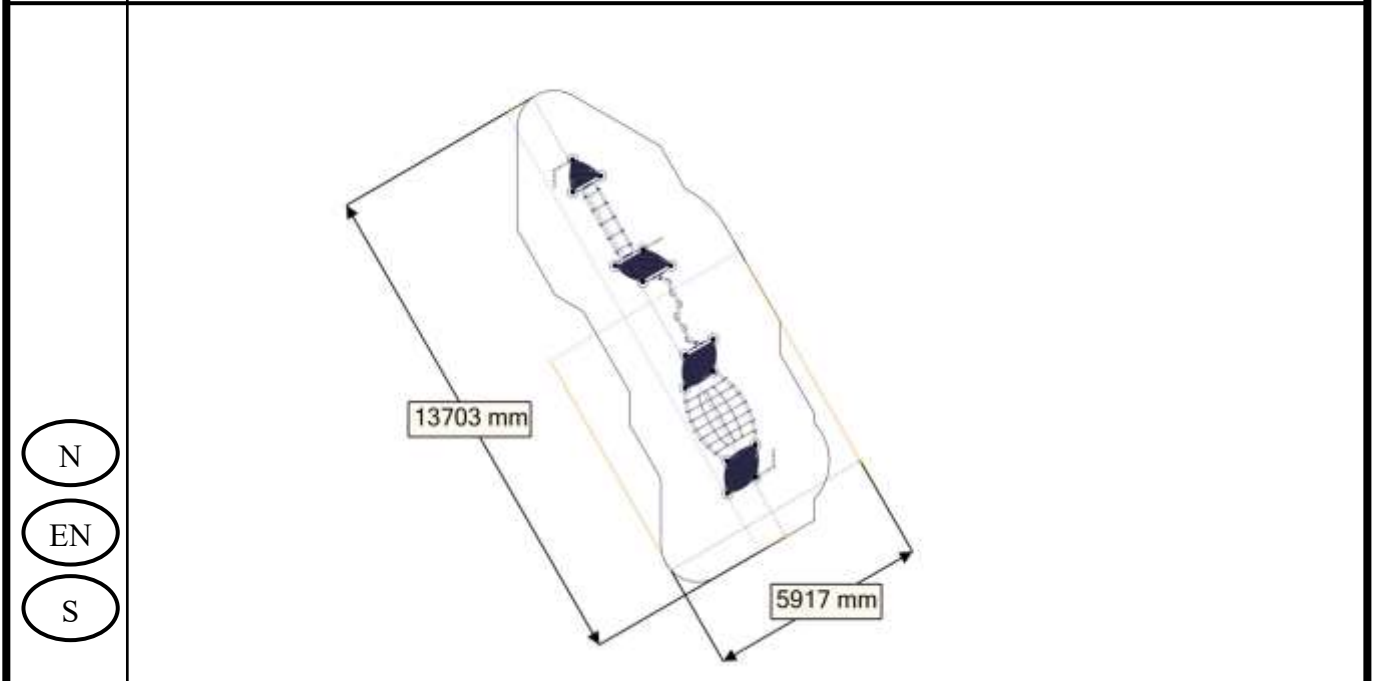

**Anbefalt arealbehov ved montering / Recommended working space / Rekommenderad arealbehov vid montering**







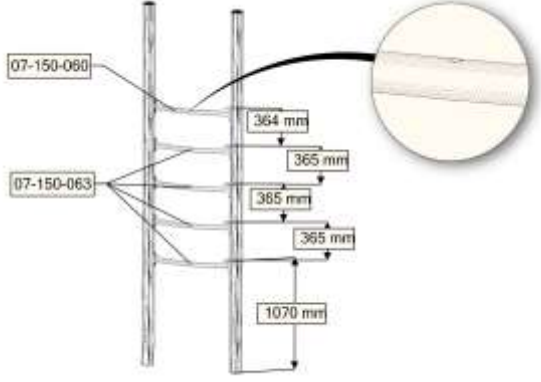
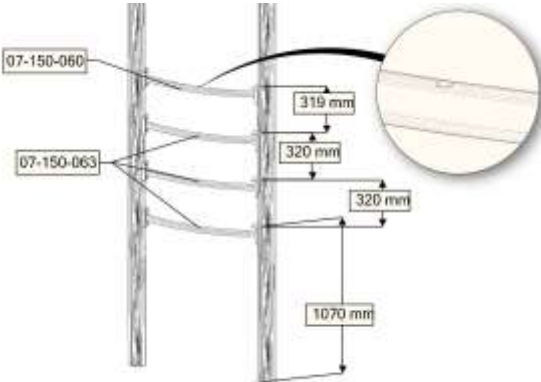





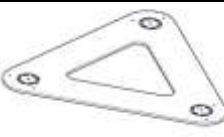

**Boltpakker for / Boltpackage for / Bultpaket för**

Sign. \_\_\_\_\_

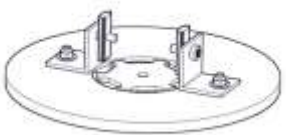
Stolpe 6SP_110		Navne	Artnr/dimensjon	Ant	Lev
		Stolpe L=3450 (2850-600)	07-100-334	11	
Stolpe end		Navne	Artnr/dimensjon	Ant	Lev
		Stopl end	04-400-100	15	
Ribbevegg Gulv 1900	Ant= 1	Navn	Artnr/dimensjon	Ant	Lev
		2 stopper L=3450	07-100-334	2	
		1 sperrerør med hull	07-150-061	1	
		4 sperrerør	07-150-060	4	
		Torx M8x25(20)	04-000-025	20	
		Brikke 120_1T	04-060-120	8	
Ribbevegg Gulv 1400	Ant= 1	Navn	Artnr/dimensjon	Ant	Lev
		2 stopper L=3450	07-100-334	2	
		1 sperrerør med hull	07-150-061	1	
		3 sperrerør	07-150-060	3	
		Brikke 120_1T	04-060-120	6	
		Torx M8x25(16)	04-000-025	16	

**Boltpakker for / Boltpackage for / Bultpaket för**











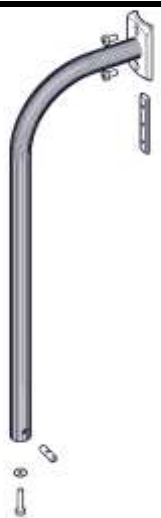



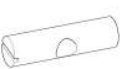

Sign. \_\_\_\_\_

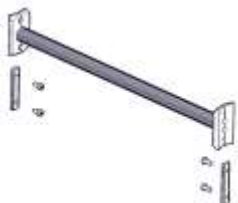















<b>Fundament 07-400-103 3stolpe</b>	<b>Ant= 4</b>	<b>Navn</b>	<b>Artnr/dimensjon</b>	<b>Ant</b>	<b>Lev</b>
		3Kant fun plate (1)	07-400-003	4	
		Vinkel 50x50x50(6)	04-070-050	24	
		Brikke 50_1T(6)	04-060-050	24	
		Torx M8x30 (6) Torx M8x25(6)	04-000-030 04-000-025	24 24	
		Skive M8 (12)	04-055-008	48	
		Låsemutter M8 (6)	04-040-008	24	
<b>Fundament</b>	<b>Ant= 3</b>	<b>Navn</b>	<b>Artnr/dimensjon</b>	<b>Ant</b>	<b>Lev</b>
		Funplate (1)	07-400-001	3	
		Vinkel 50x50x4 11mm (2)	04-070-050	6	
		Brikke 50 (2)	04-060-050	6	
		Torx M8x25 (2) Torx M8x30 (2)	04-000-025 04-000-030	6 6	
		Skive M8 (4)	04-055-008	12	
		Mutter M8 (2)	04-040-008	6	



**Boltepakker for / Boltpackage for / Bultpaket för**

Sign. \_\_\_\_\_











Sluse: 07-500-064	Ant= 6	Navn	Artnr/dimensjon	Ant	Lev
		Sluse (1)	07-150-064	6	
		Brikke 120_2T (1)	04-060-120	6	
		Torx M8x25 (2)	04-000-025	12	
		Torx M8x45 (1)	04-000-045	6	
		Skive M8 Stor (1)	04-055-008	6	
	Hullsemutter (1)	04-018-060	6		
Sperrerør_ : 07-500-061 Med hull gulv	Ant= 19	Navn	Artnr/dimensjon	Ant	Lev
		Sperrerør_gulv (1)	07-150-061	19	
		Brikke 120_2T (2) 6 st på stolpe	04-060-120	0	
		Torx M8x25 (4)	04-000-025	76	
Sperrerør: 07-500-062 Rett	Ant= 3	Navn	Artnr/dimensjon	Ant	Lev
		Sperrør rett (1)	07-150-062	3	
		Brikke 120_2T (2)	04-060-120	6	
		Torx M8x25 (4)	04-000-025	12	
Sperrerør: 07-500-060	Ant= 7	Navn	Artnr/dimensjon	Ant	Lev
		Sperrerør bøyet (1)	07-150-060	7	
		Brikke 120_3T (2)	04-060-120	14	
		Torx M8x25 (4)	04-000-025	28	

<b>Boltepakker for / Boltpackage for / Bultpaket för</b>			Sign. _____		
<b>S-treppa 07-500-028</b>	<b>Ant=2</b>	<b>Navne</b>	<b>Artnr/dimensjon</b>	<b>Ant</b>	<b>Lev</b>
		S-treppa	07-200-028	2	
		0gr 120_2H2V (1)	07-150-020	2	
		Brikke 120_2T(1)	04-060-120	2	
		TorxM8x35 (2+2)	04-000-035	8	
		Skive M8 (2)	04-050-008	4	
		Låsemutter M8 (2)	04-040-008	4	
		Fundamentplatte (1) 2 hull	00-003-009	2	
<b>Brannstang:07-500-037</b>	<b>Ant=1</b>	<b>Navne</b>	<b>Artnr/dimensjon</b>	<b>Ant</b>	<b>Lev</b>
		Brannstang (1)	07-200-037	1	
		0gr 120_2H2V (1)	07-150-020	1	
		Brikke 120_2T(1)	04-060-120	1	
		TorxM8x35 (4)	04-000-035	4	
		Skive M8 (2)	04-050-008	2	
		Låsemutter M8 (2)	04-040-008	2	
		Fundamentplatte (1) 2 hull	00-003-009	1	

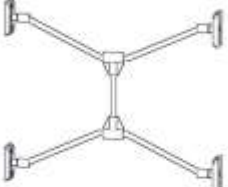
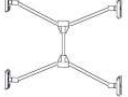





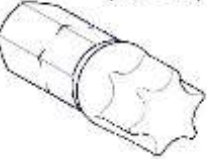
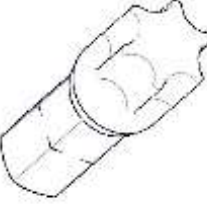



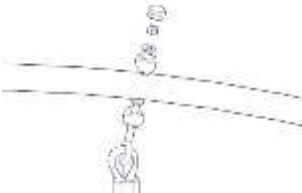

**Boltepakker for / Boltpackage for / Bultpaket för**

Sign. \_\_\_\_\_

<b>Gulv 07-300-101 STD</b>	<b>Ant= 7</b>	<b>Navne</b>	<b>Artnr/dimensjon</b>	<b>Ant</b>	<b>Lev</b>
		gulv (1)	07-300-101	7	
		Møbelknapp (3)	04-030-011 M8_13_17	21	
		Torx M8x45 (3)	04-000-045	21	
		Plug 9mm (6)	04-090-002	42	
<b>Spidernett 880</b>	<b>Ant= 3</b>	<b>Navne</b>	<b>Artnr/dimensjon</b>	<b>Ant</b>	<b>Lev</b>
		Spidernett Inkl 0gr beslag	07-500-265	3	
		Brikke 120 3xM8 (4)	04-060-120	12	
		Torx M8x25 (8)	04-000-025	24	
<b>Produktmerke</b>	<b>Ant= 1</b>	<b>Navn</b>	<b>Artnr/dimensjon</b>	<b>Ant</b>	<b>Lev</b>
		0gr 150_2H (2) Med Produktmerke	????	1	
		Brikke 150_2T(2)	04-060-151	1	
		Torx M8x35 (2)	04-000-035	2	
<b>Bit Torx TX45 (Drive 1/4")</b>	<b>Ant= 1</b>	<b>Navn</b>	<b>Artnr/dimensjon</b>	<b>Ant</b>	<b>Lev</b>
		Bit Torx TX45	04-001-045	1	









**Boltepakker for / Boltpackage for / Bultpaket för**

Sign. \_\_\_\_\_.

Tordert nett	Ant=1	Navn	Artnr/dimensjon	Ant	Lev
 		Tordert Nett (1)	07-500-302	1	
		Rør for tordert nett	07-500-301	2	
		0gr_200_2H(4)	07-150-023	4	
		Brikke 200_2T(4)	04-060-200	4	
		TorxM8x35 (8)	04-000-035	8	
		Plasrørdel(28)	05-300-036	28	
		PlastRørdel end(14)	05-300-036	14	
		Skive covered(28)	05-300-036	28	
		M10 mutter (14)	04-040-010	14	











**Boltepakker for / Boltpackage for / Bultpaket för**

Sign. \_\_\_\_\_.

Beveglige Armgang	Ant=1	Navn	Artnr/dimensjon	Ant	Lev
		Mellom del Armgang (2)	07-500-282	2	
		Armgang (1)	07-500-281	1	
		0gr_150_2H(4)	07-150-022	4	
		Brikke 150_2T(4)	04-060-151	4	
		Umbrako M10x100 (8)	04-036-100	8	
		TorxM8x35 (8)	04-000-035	8	
		Skive M10 stor(8)	04-055-010	16	
		Låssemuter M10	04-040-010	8	

**Boltepakker for / Boltpackage for / Bultpaket för**

Sign. \_\_\_\_\_.

Bru med ringer	Ant=1	Navn	Artnr/dimensjon	Ant	Lev
		Dobbelt ringerrør (1)	07-500-291	1	
		Ringer (5)	07-500-292	5	
					
		0gr_150_2H(4)	07-150-022	4	
		Brikke 150_2T(4)	04-060-151	4	
		TorxM8x35 (8)	04-000-035	8	
		Plasrørdel(20)	05-300-036	20	
		PlastRørdel end(10)	05-300-036	10	
		Skive covered(20)	05-300-036	20	
		M10 mutter (10)	04-040-010	10	

**Fundamentering med betong / Foundation concrete / Förankring med betong**

(N)	Støtsand		(N)	(UK)	(S)
(UK)	Safer surface		Bakkenivå	Ground level	Marknivå
(S)	Stridsan		↓	Ref NS-EN 177	
(N)	Komprimert masse.	betong			
(UK)	Compressed mass.	concrete			
(S)	Komprimerad massa.	betong			

**Fundamentering uten betong / Foundation without concrete / Förankring utan betong**

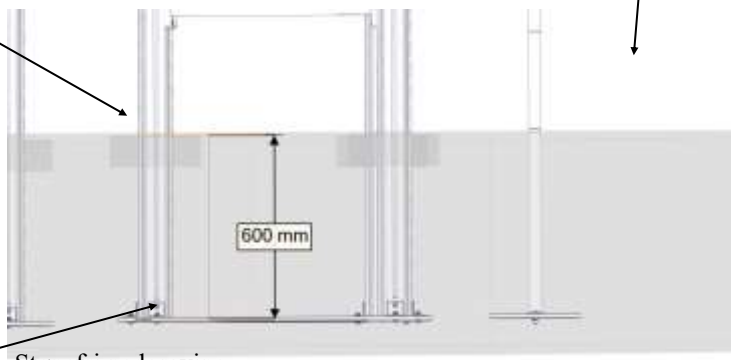
(N)	Støtsand		(N)	(UK)	(S)
(UK)	Safer surface		Bakkenivå	Ground level	Marknivå
(S)	Stridsan		↓	Ref NS-EN 1177	
(N)	Komprimert masse	Støpefri nedgraving			
(UK)	Compressed mass	Concrete-free anchor			
(S)	Komprimerad massa	Nedgrävningfundament			

(N)	Alle mål er oppgitt i millimeter
(UK)	Scale measured in mm
(S)	Alla mått är i millimeter.

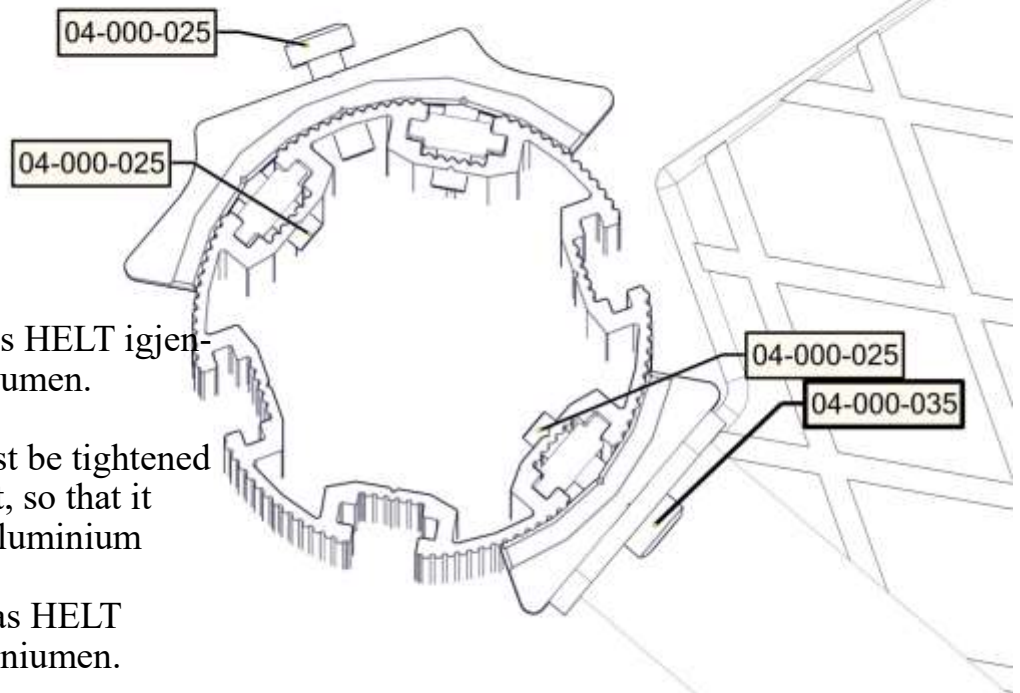

N

Bolten skrues HELT igjennom aluminiumen.

UK

The bolt must be tightened in to the post, so that it pierces the aluminium

S

Bulten skruvas HELT igjennom aluminiumen.

### Fallhøyder / Free height of fall / Fallhöjder

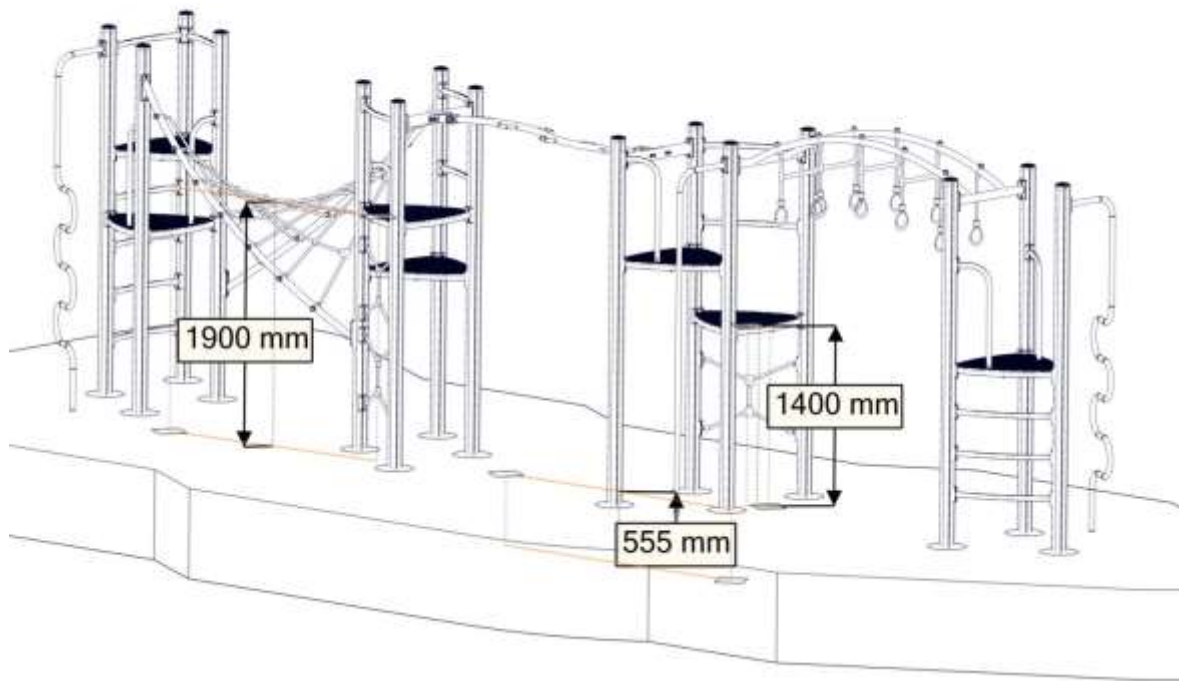

### Sikkerhetszone / Safety zone / Säkerhetszon

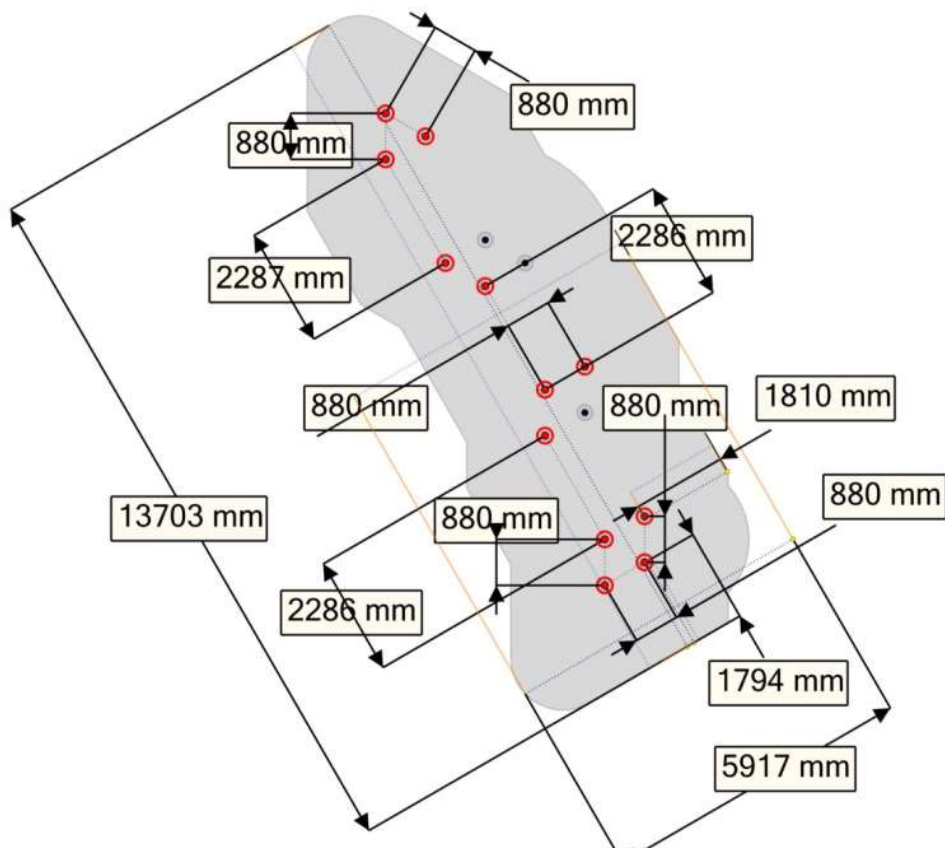



**Plassering av forankringer / Ground plan / Placering av förankringar**

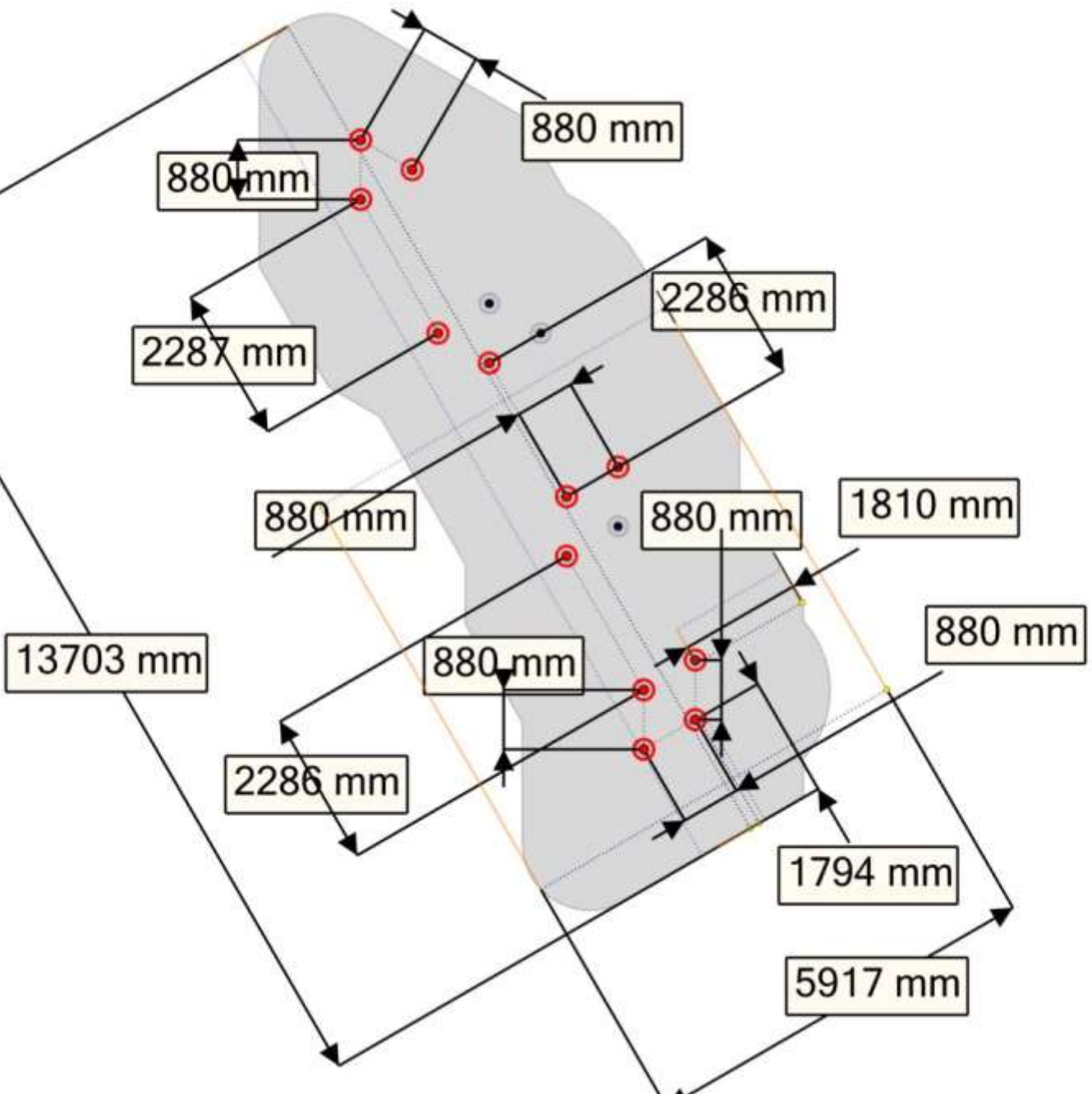

N

Alle mål er oppgitt i millimeter

UK

Scale measured in mm

S

Alla mått är i millimeter.

**Montering av lekeapparatet / Assembly instructions / Montering av lekredskapet**

Brikke påmontert hos Søve

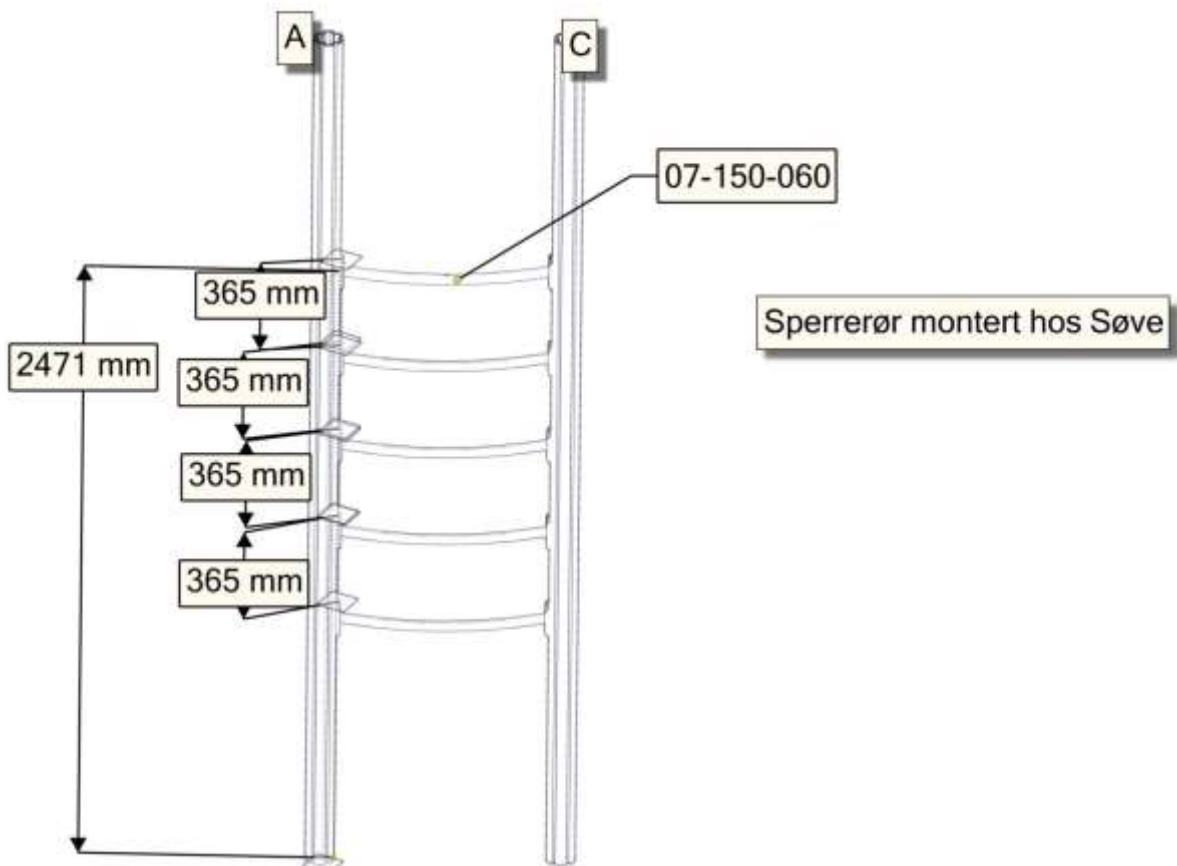
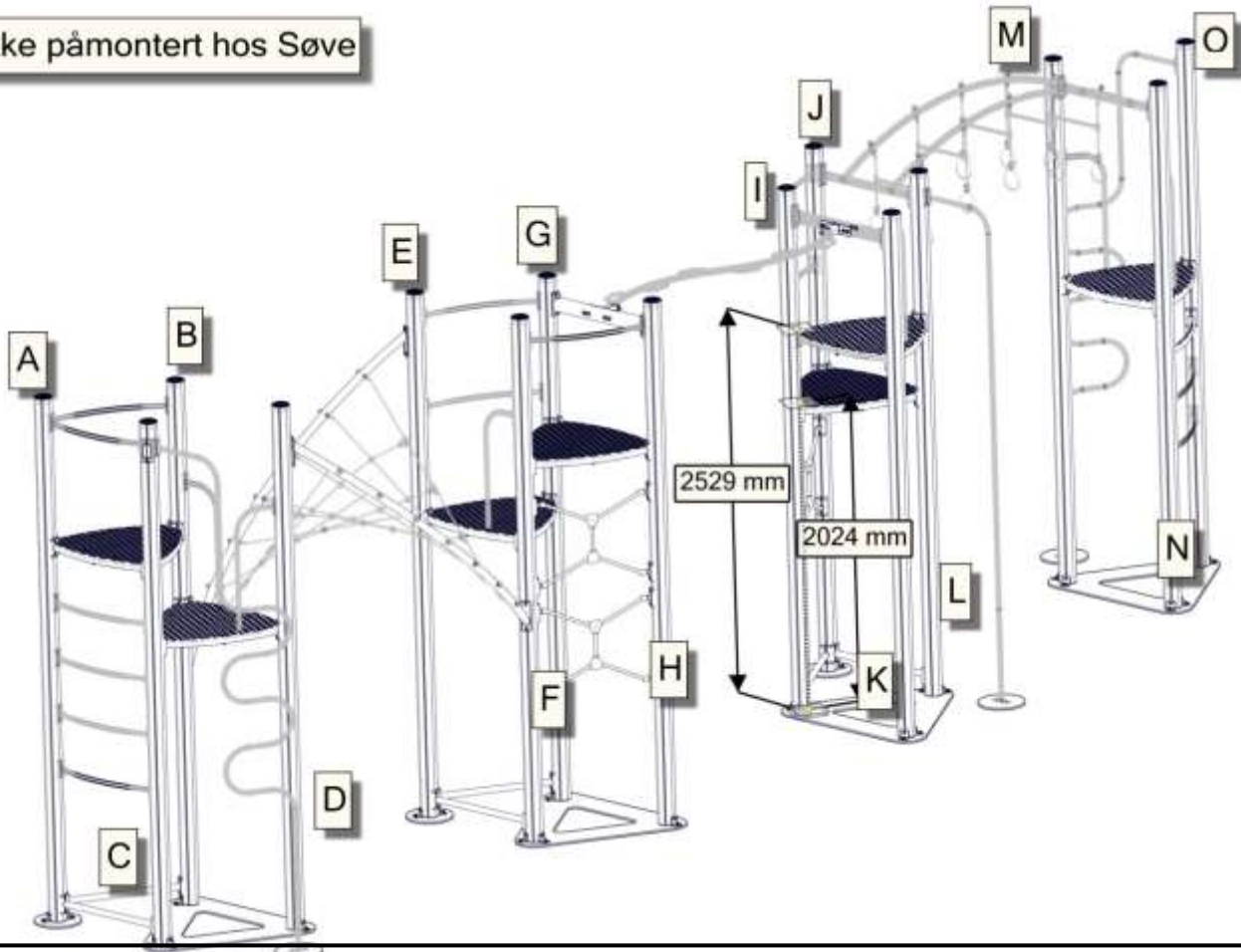

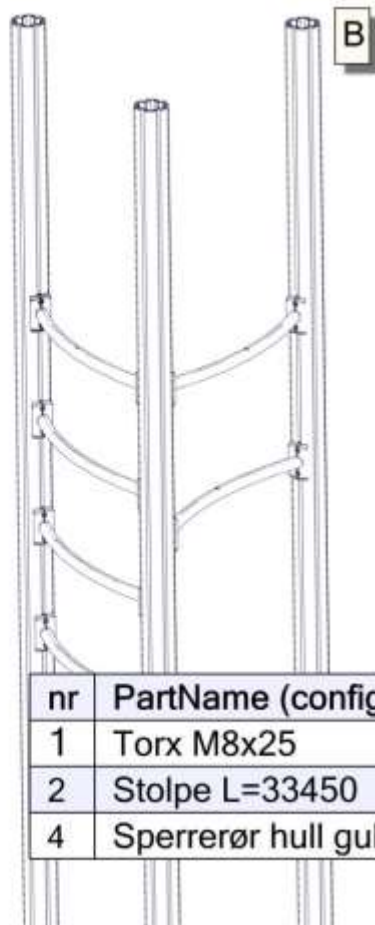

nr	PartName (config)	Artnr (config)	Antall
1	Torx M8x25	04-000-025	8
2	Stolpe L=33450	07-100-334	1
4	Sperrerør hull gulv	07-150-060	2

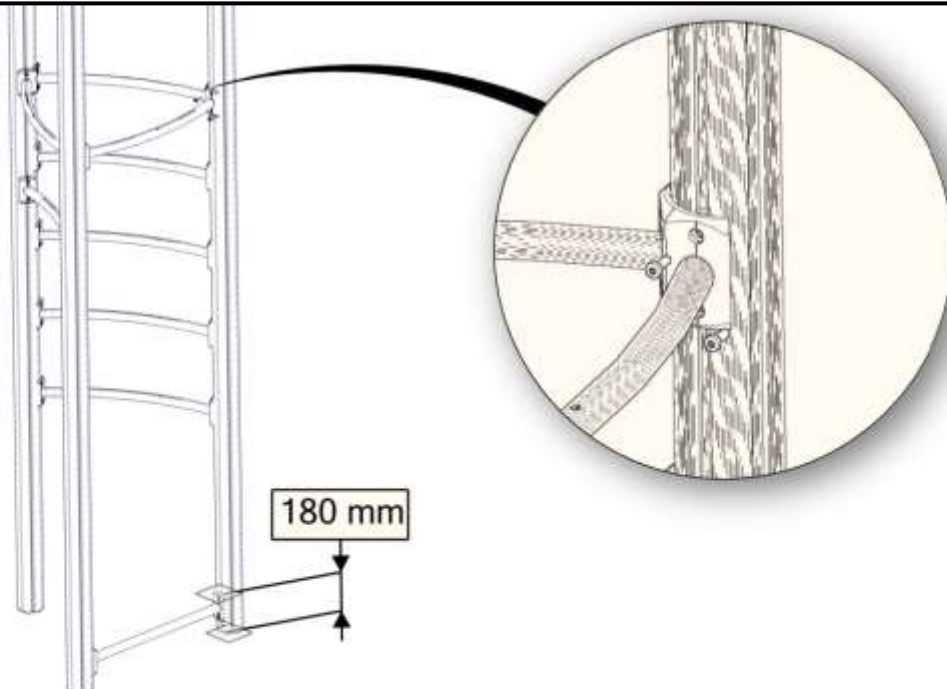

nr	PartName (config)	Artnr (config)	Antall
1	Torx M8x25	04-000-025	8
2	Brikke 120 3xM8	04-060-120	2
3	Sperrerør hull gulv	07-150-060	1
4	Sperrerør rett	07-150-062	1

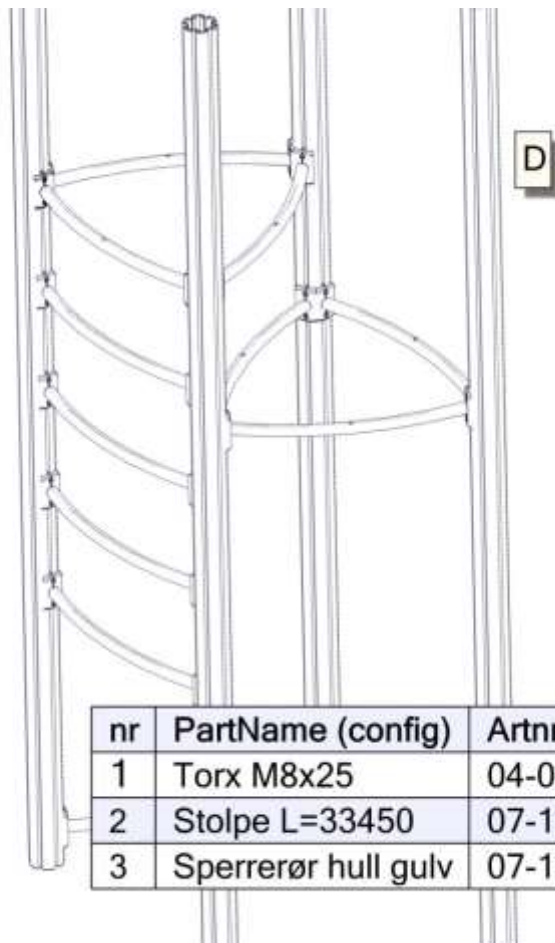

nr	PartName (config)	Artnr (config)	Antall
1	Torx M8x25	04-000-025	8
2	Stolpe L=33450	07-100-334	1
3	Sperrerør hull gulv	07-150-060	2

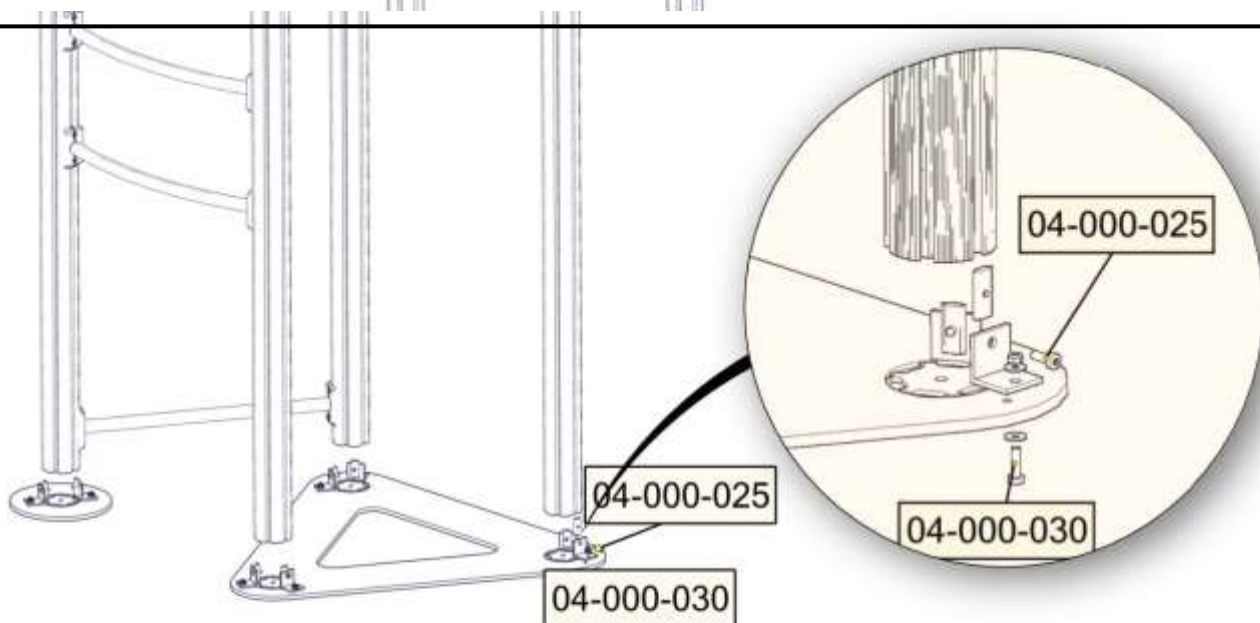

nr	PartName (config)	Artnr (config)	Antall
1	Torx M8x25	04-000-025	8
2	Torx M8x30	04-000-030	8
3	Låsemutter M8	04-040-008	8
4	Skive M8 stor	04-055-008	16
5	Brikke50 1XM8	04-060-050	8

nr	PartName (config)	Artnr (config)	Antall
6	Vinkel 50x50x50x5 11mm hull	04-070-050	8
7	Fundamentplate 1 stolpe	07-400-011	1
8	Fundametplate 3 stolper	07-400-013	1



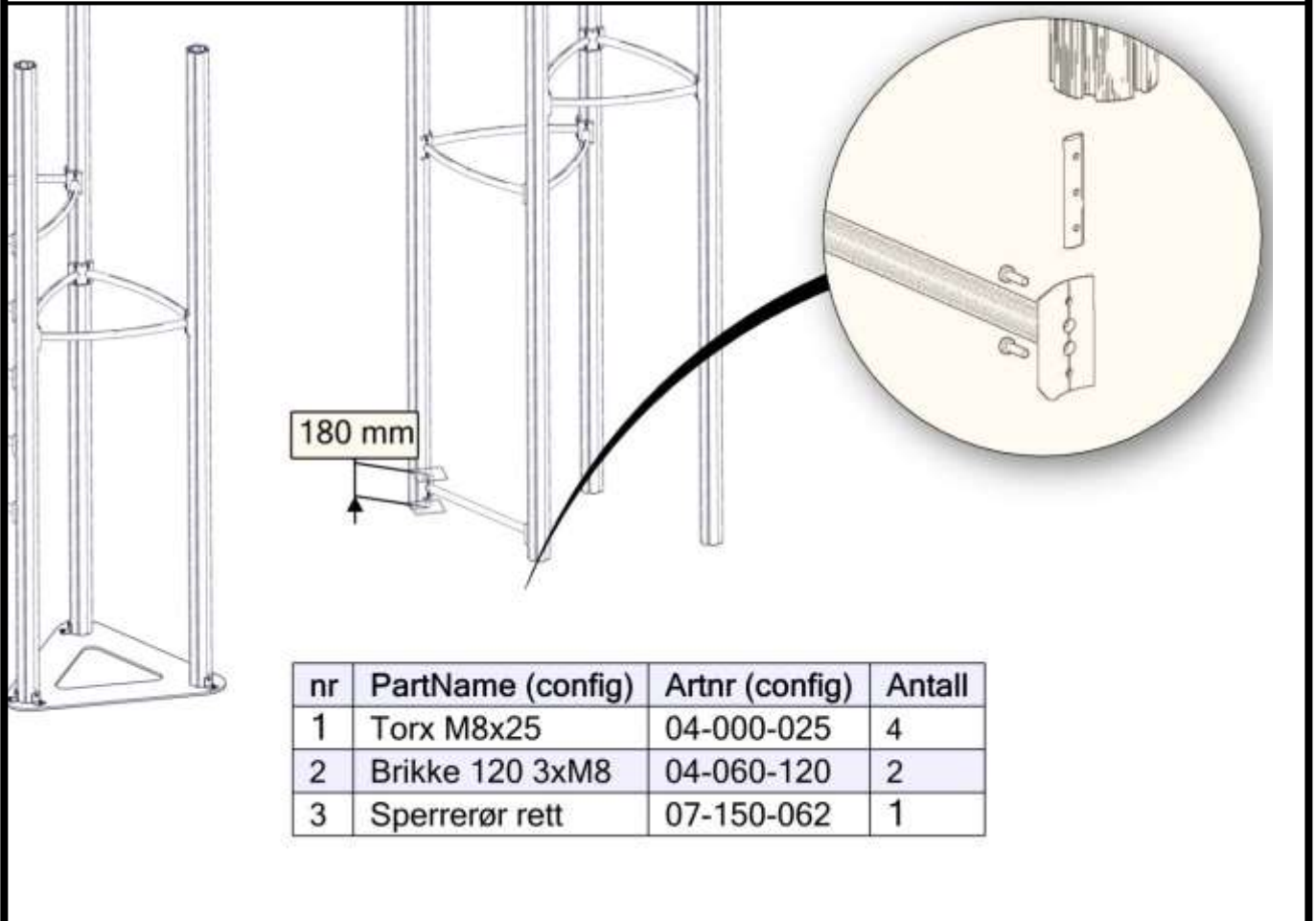
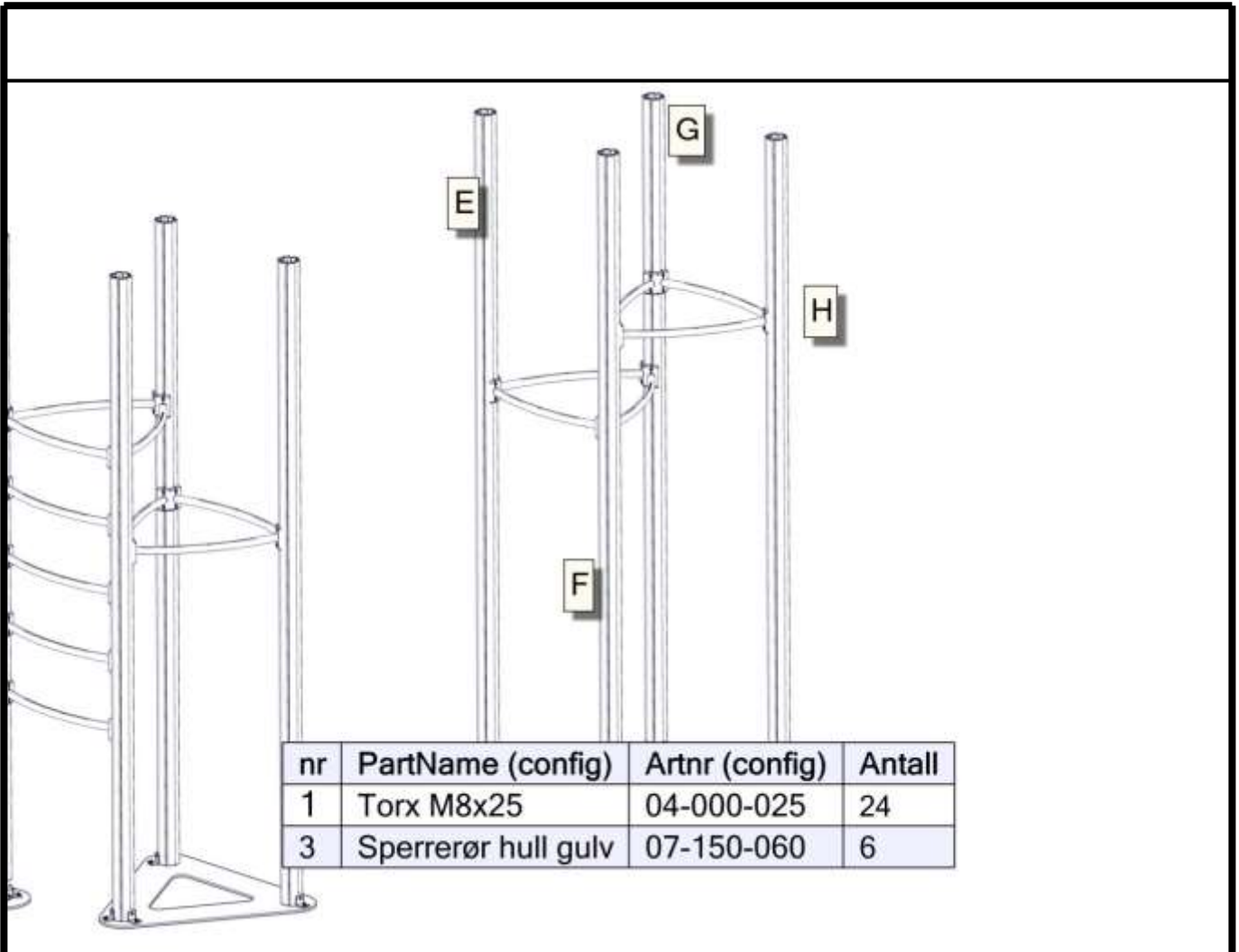

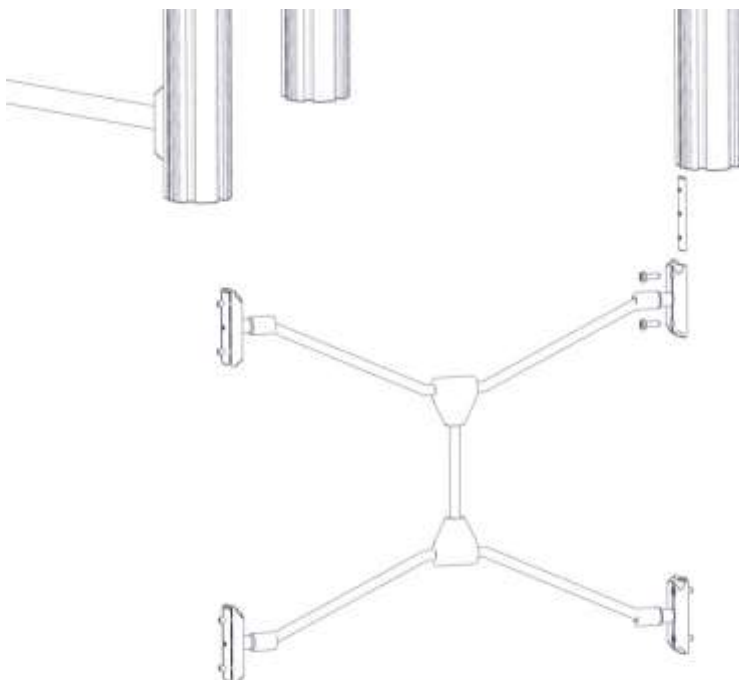
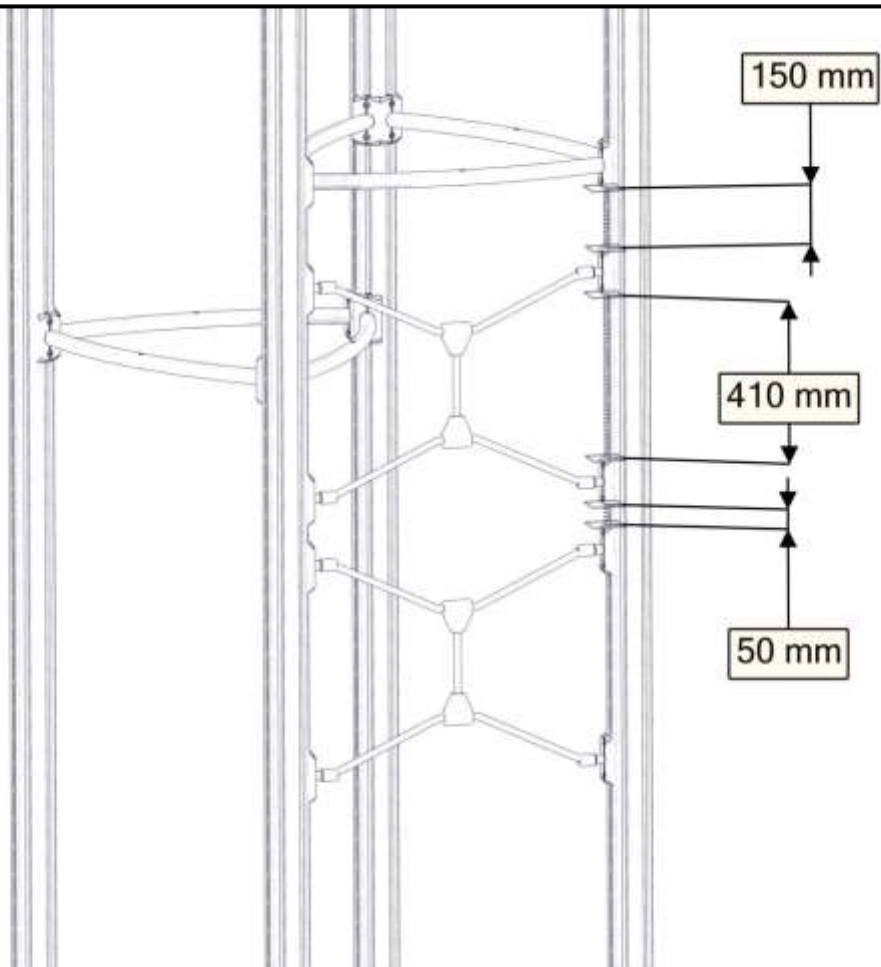

nr	PartName (config)	Artnr (config)	Antall
1	Torx M8x25	04-000-025	16
2	Brikke 120 3xM8	04-060-120	8
3	Spidernet 880	07-500-265	2

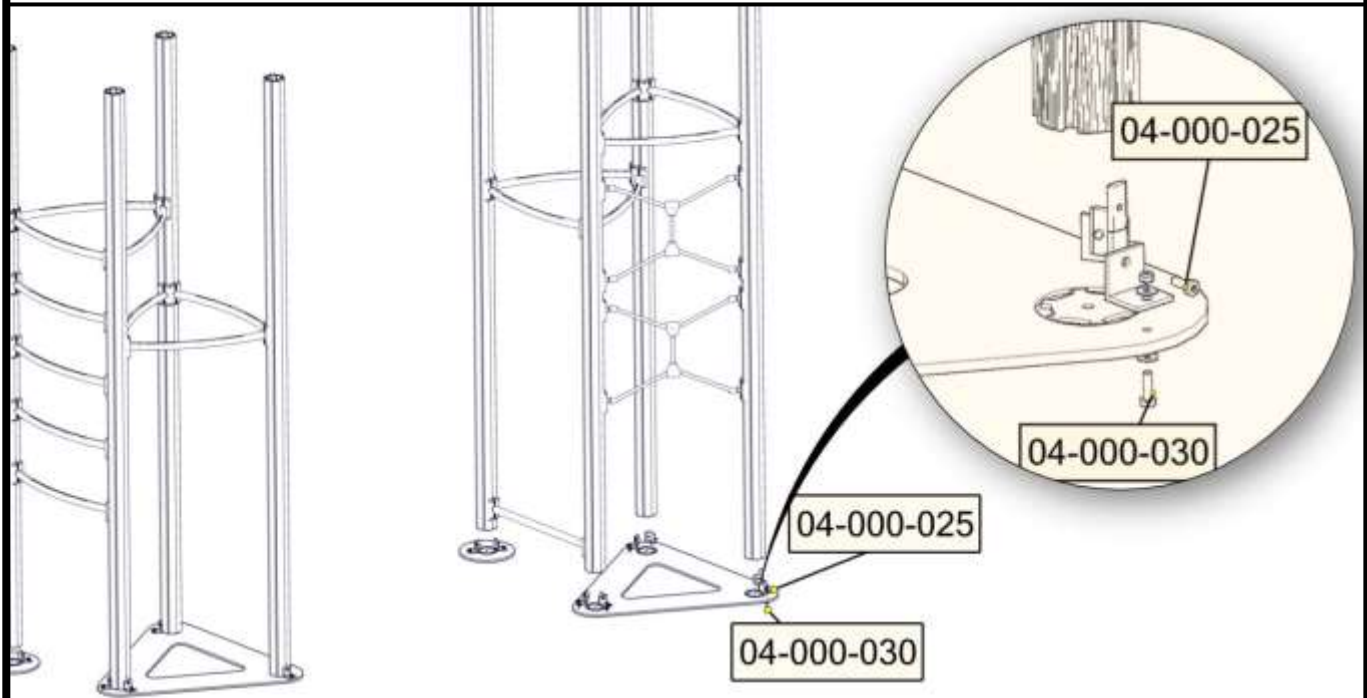

nr	PartName (config)	Artnr (config)	Antall
1	Torx M8x25	04-000-025	8
2	Torx M8x30	04-000-030	8
3	Låsemutter M8	04-040-008	8
4	Skive M8 stor	04-055-008	16
5	Brikke50 1XM8	04-060-050	8

nr	PartName (config)	Artnr (config)	Antall
6	Vinkel 50x50x50x5 11mm hull	04-070-050	8
7	Fundamentplate 1 stolpe	07-400-011	1
8	Fundametplate 3 stolper	07-400-013	1

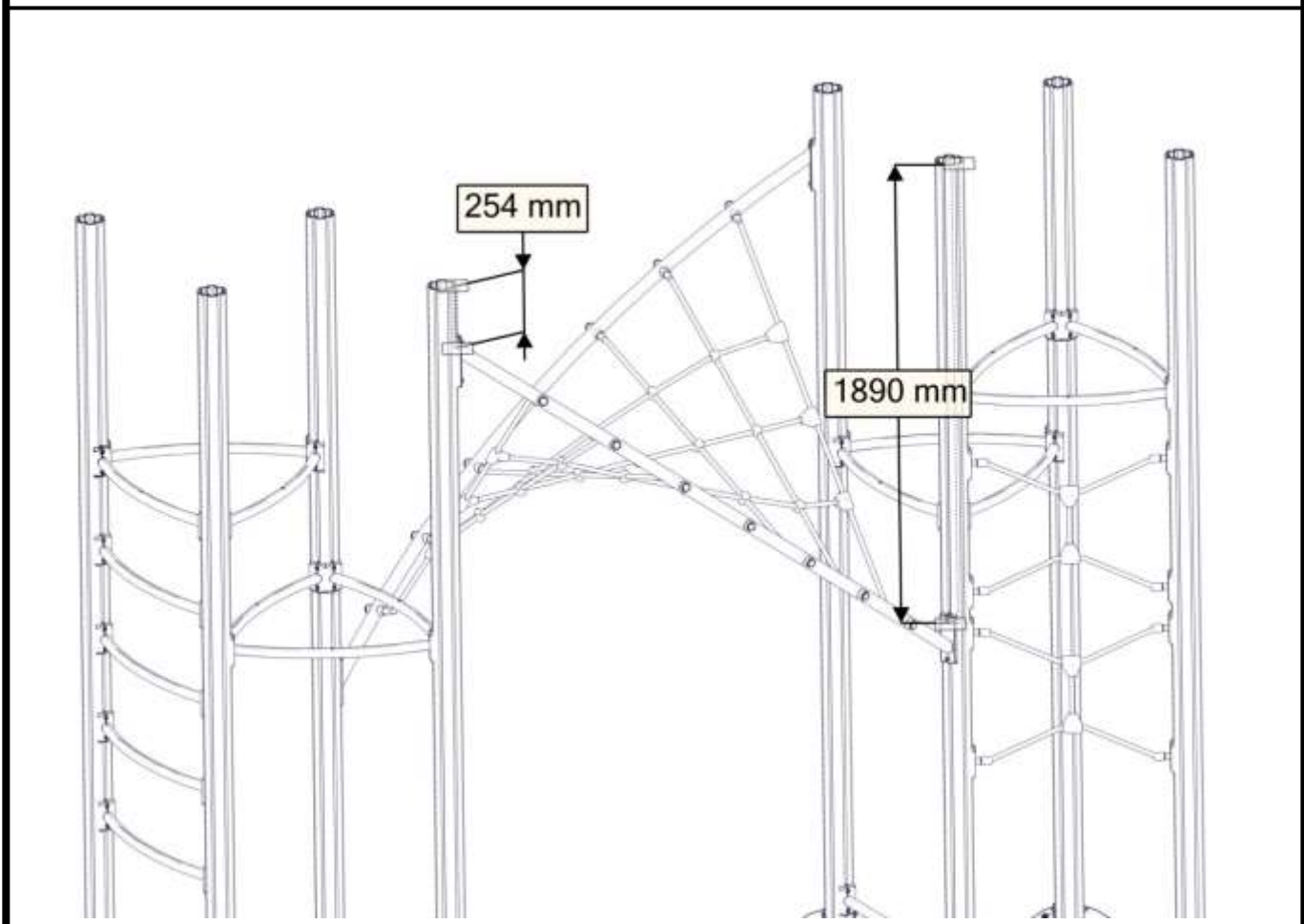



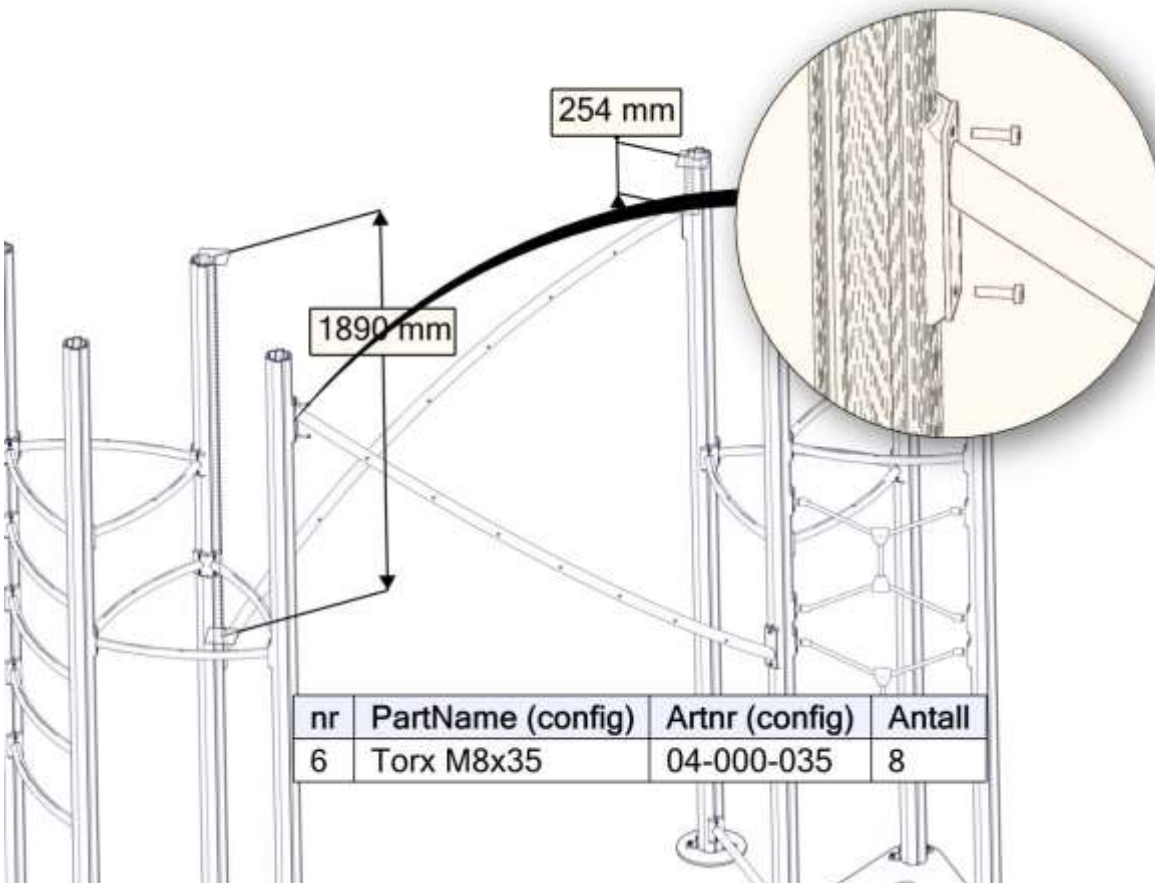
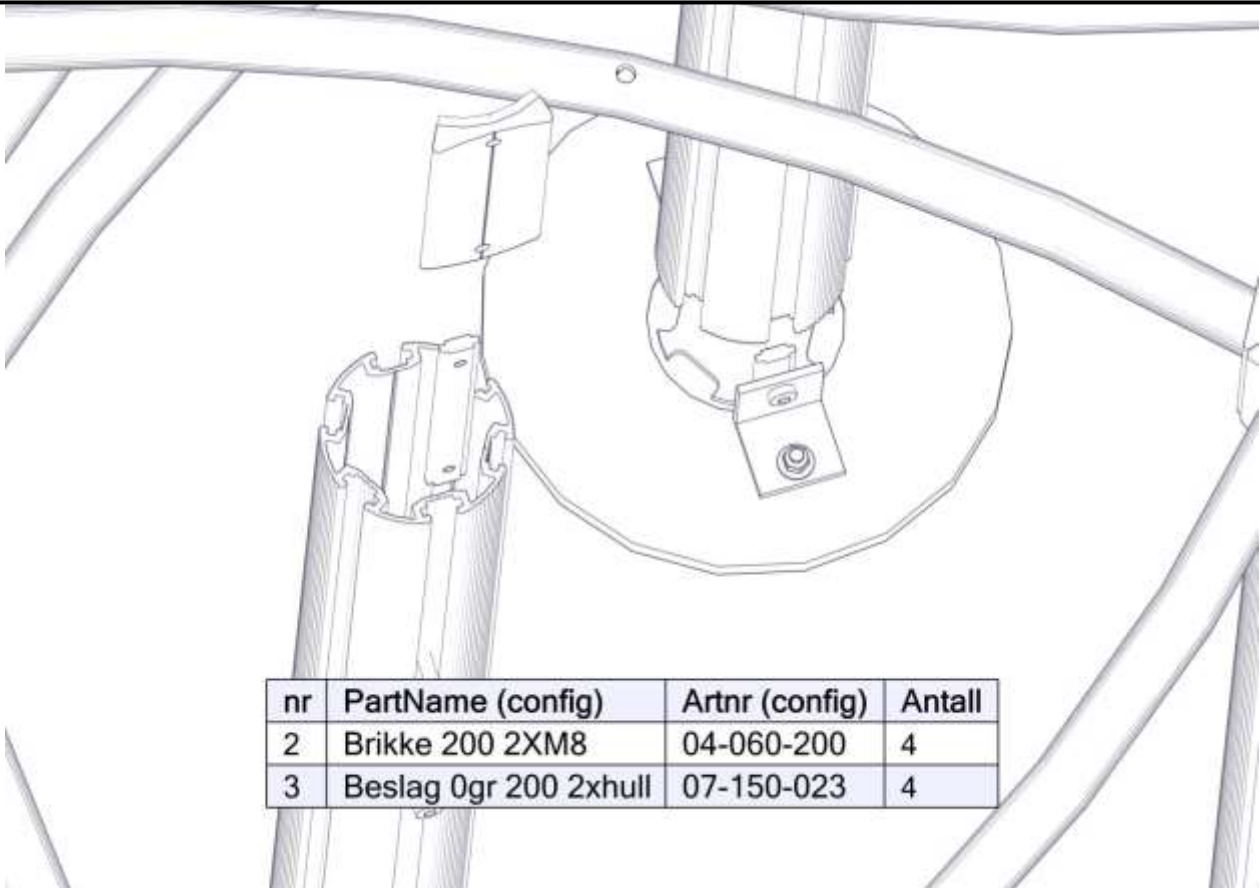

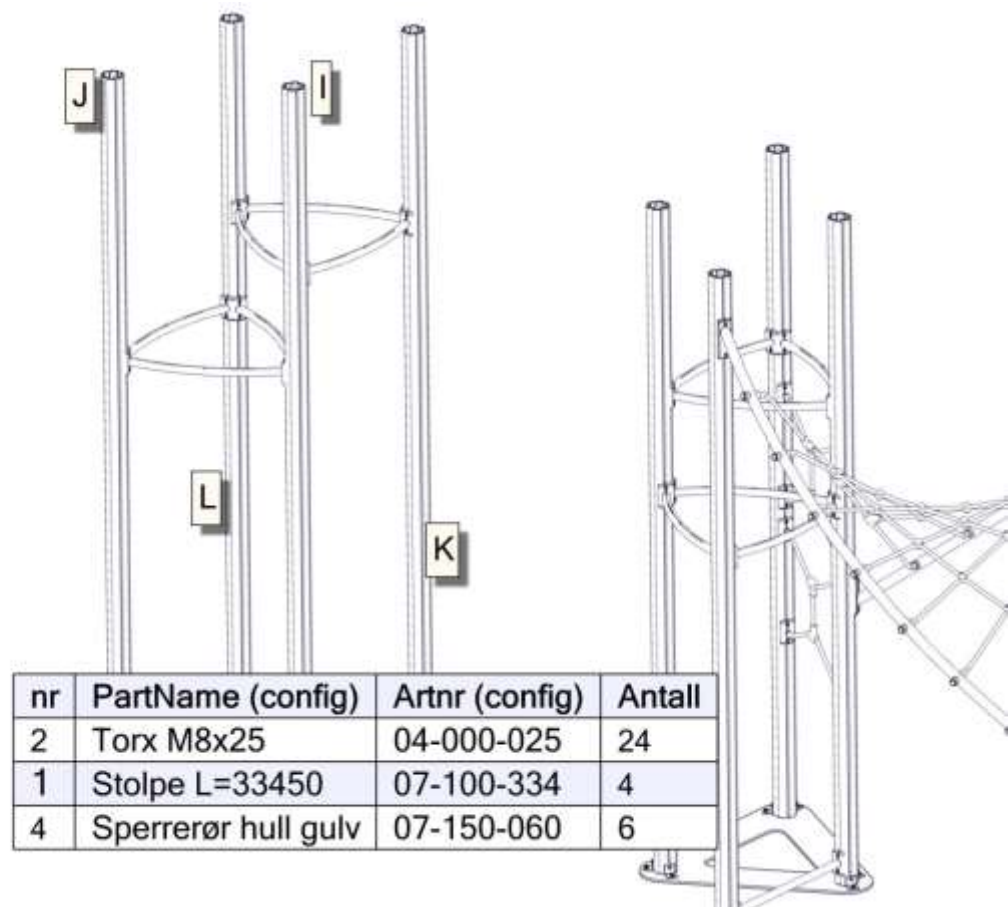
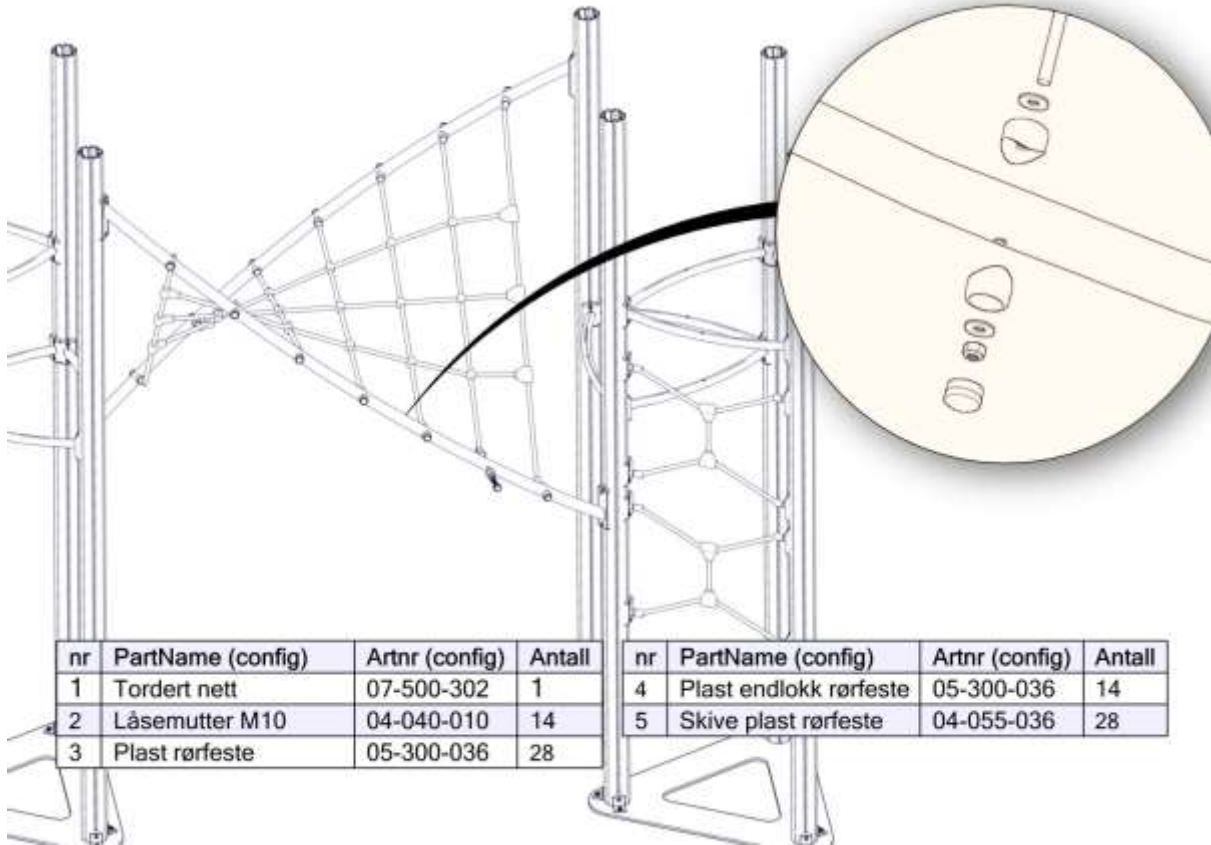

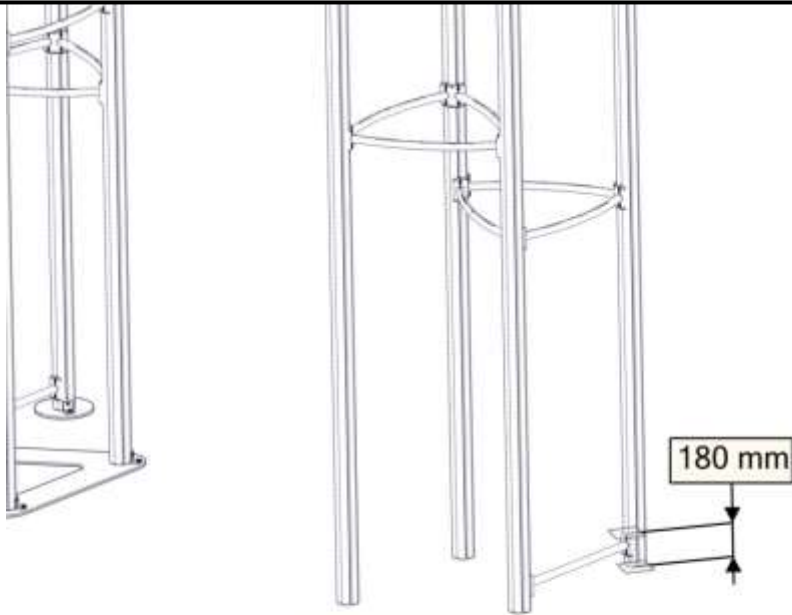

nr	PartName (config)	Artnr (config)	Antall
1	Torx M8x25	04-000-025	4
2	Brikke 120 3xM8	04-060-120	2
3	Sperrerør rett	07-150-062	1

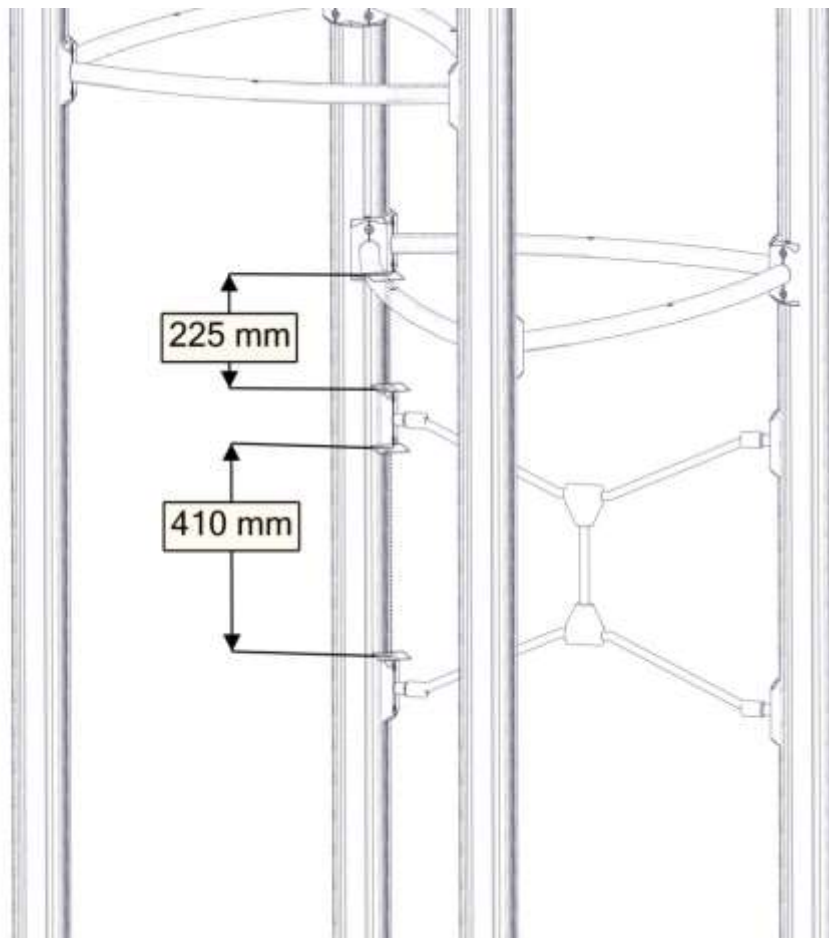

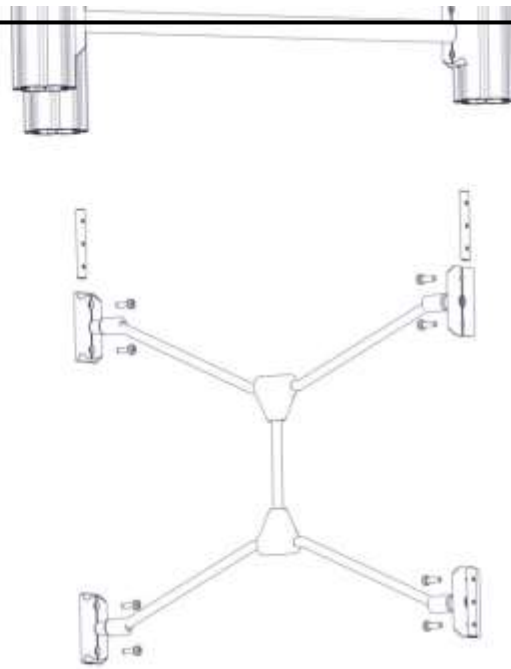

nr	PartName (config)	Artnr (config)	Antall
1	Torx M8x25	04-000-025	8
2	Brikke 120 3xM8	04-060-120	4
3	Spidernet 880	07-500-265	1

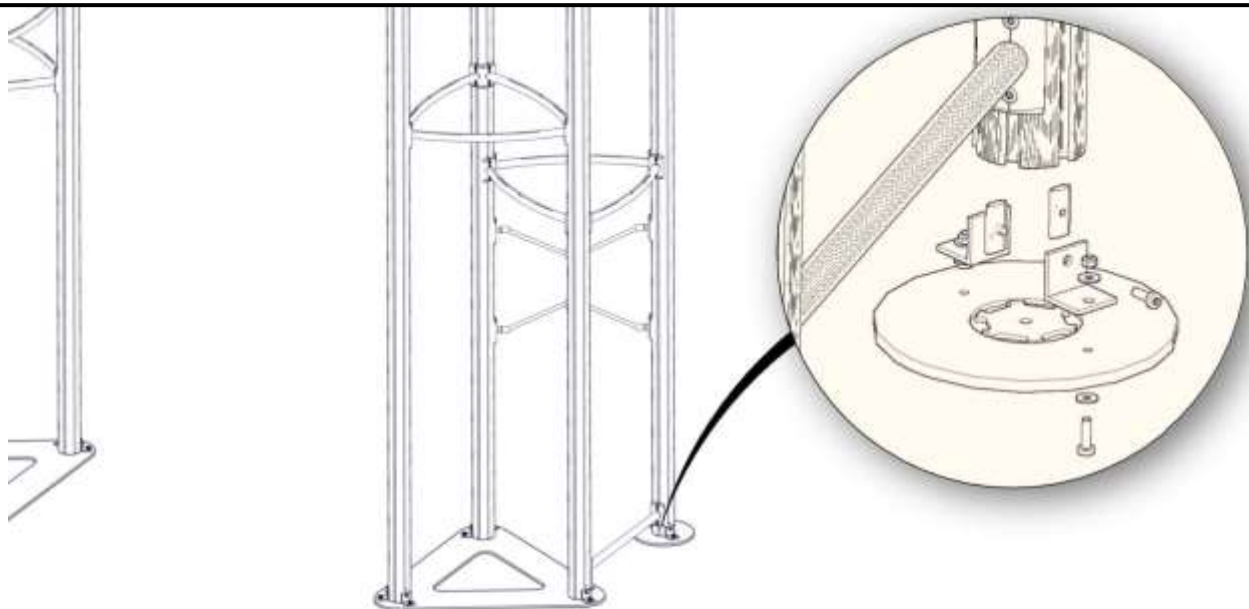

nr	PartName (config)	Artnr (config)	Antall
1	Torx M8x25	04-000-025	8
2	Torx M8x30	04-000-030	8
3	Låsemutter M8	04-040-008	8
4	Skive M8 stor	04-055-008	16
5	Brikke50 1XM8	04-060-050	8

nr	PartName (config)	Artnr (config)	Antall
6	Vinkel 50x50x50x5 11mm hull	04-070-050	8
7	Fundamentplate 1 stolpe	07-400-011	1
8	Fundametnetplate 3 stolper	07-400-013	1

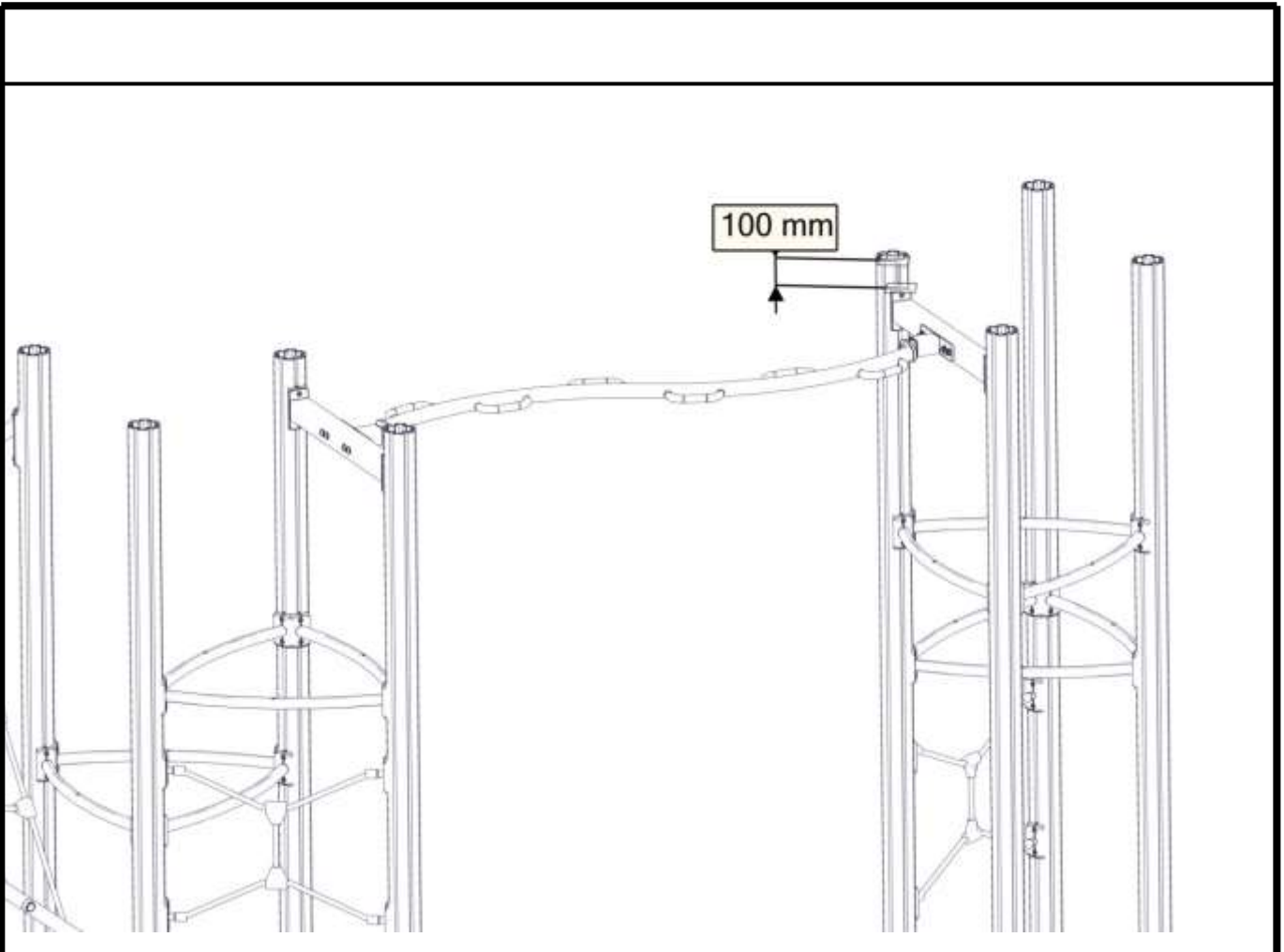

2x

nr	PartName (config)	Artnr (config)	Antall
1	Torx M8x35	04-000-035	4
2	Brikke 150 2xM8	04-060-151	2
3	Beslag 0gr 150 2xhull	07-150-022	2
5	Feste beveglige armgang	07-500-282	1



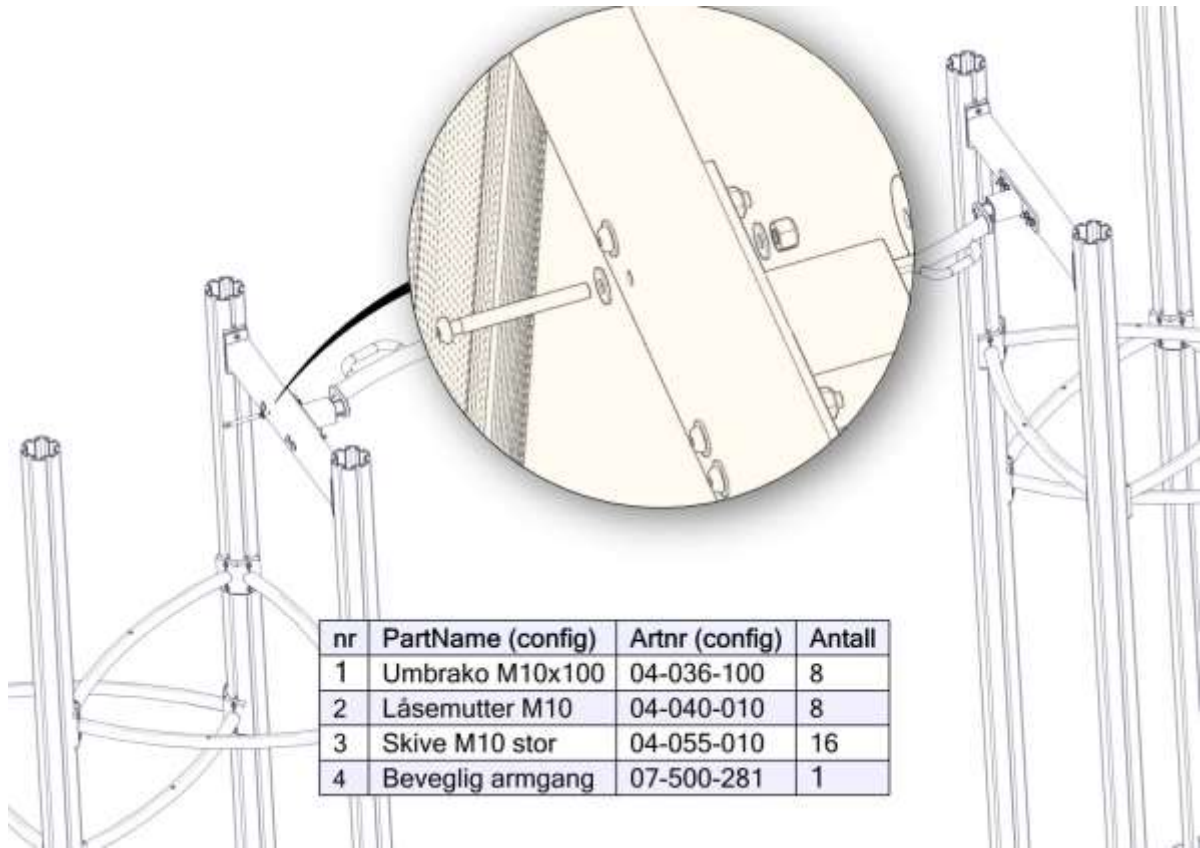

Sperrerør montert hos Søve

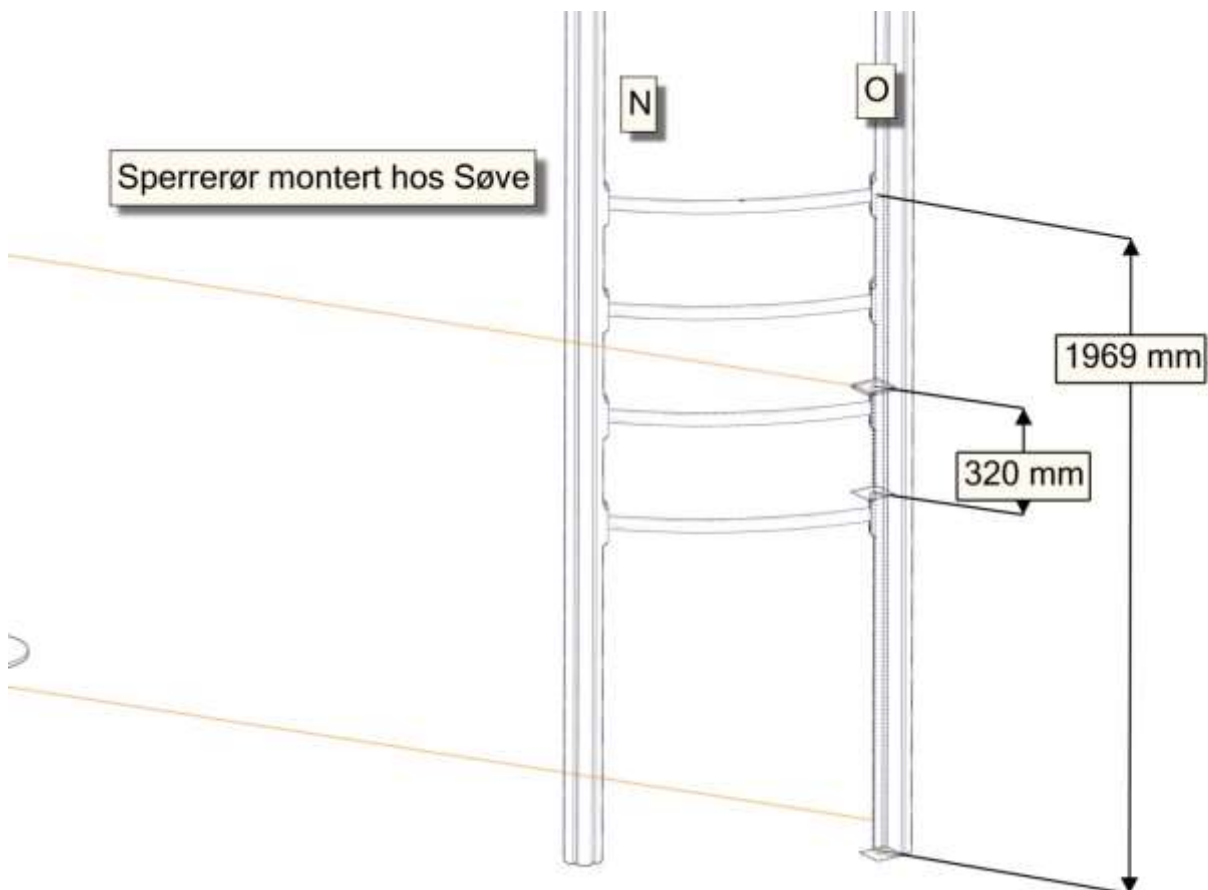



nr	PartName (config)	Artnr (config)	Antall
2	Torx M8x25	04-000-025	8
1	Stolpe L=33450	07-100-334	1
3	Sperrerør hull gulv	07-150-060	2



nr	PartName (config)	Artnr (config)	Antall
1	Torx M8x25	04-000-025	6
2	Torx M8x30	04-000-030	6
3	Låsemutter M8	04-040-008	6
4	Skive M8 stor	04-055-008	12

nr	PartName (config)	Artnr (config)	Antall
5	Brikke50 1XM8	04-060-050	6
6	Vinkel 50x50x50x5 11mm hull	04-070-050	6
7	Fundamnetplate 3 stolper	07-400-013	1



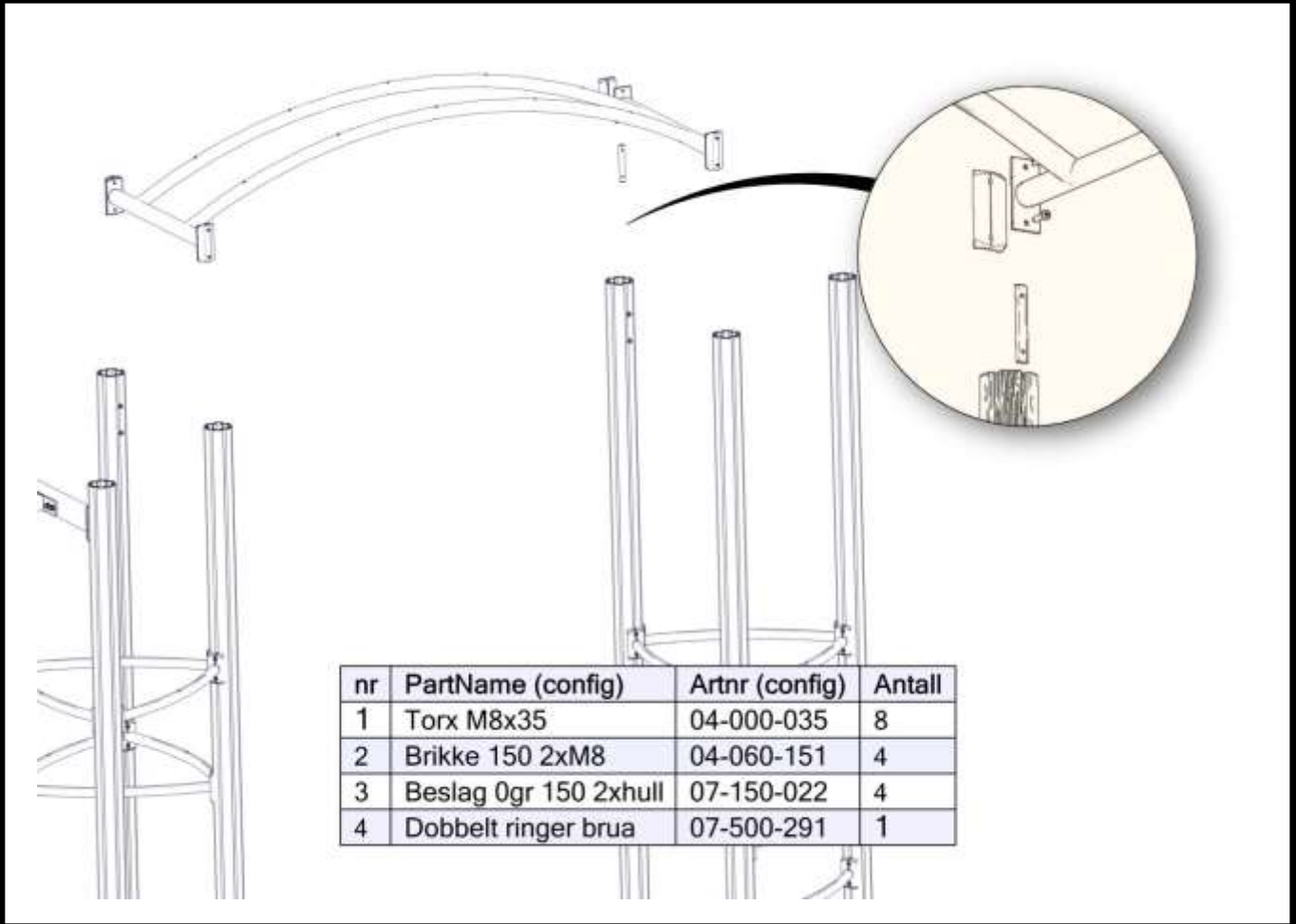
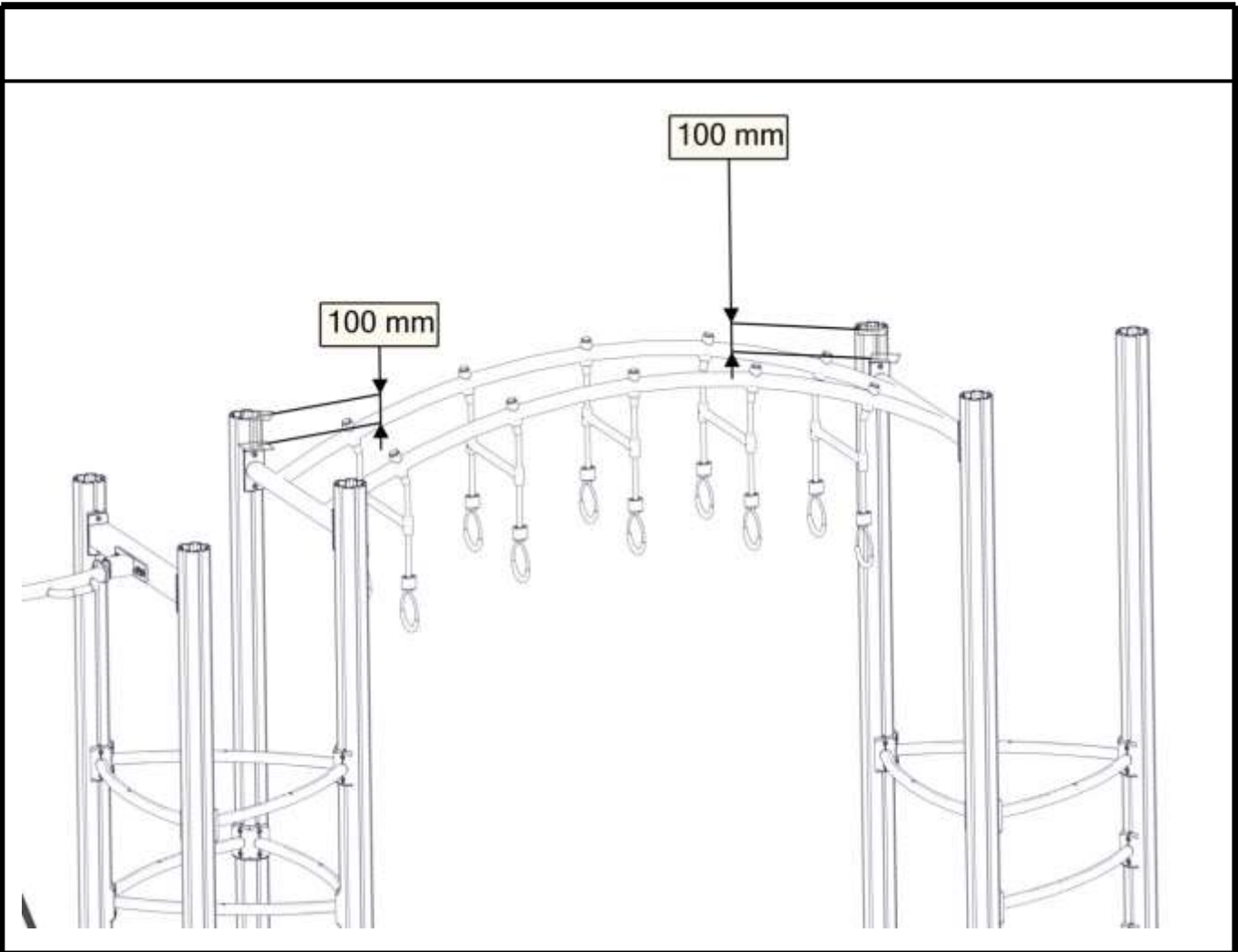

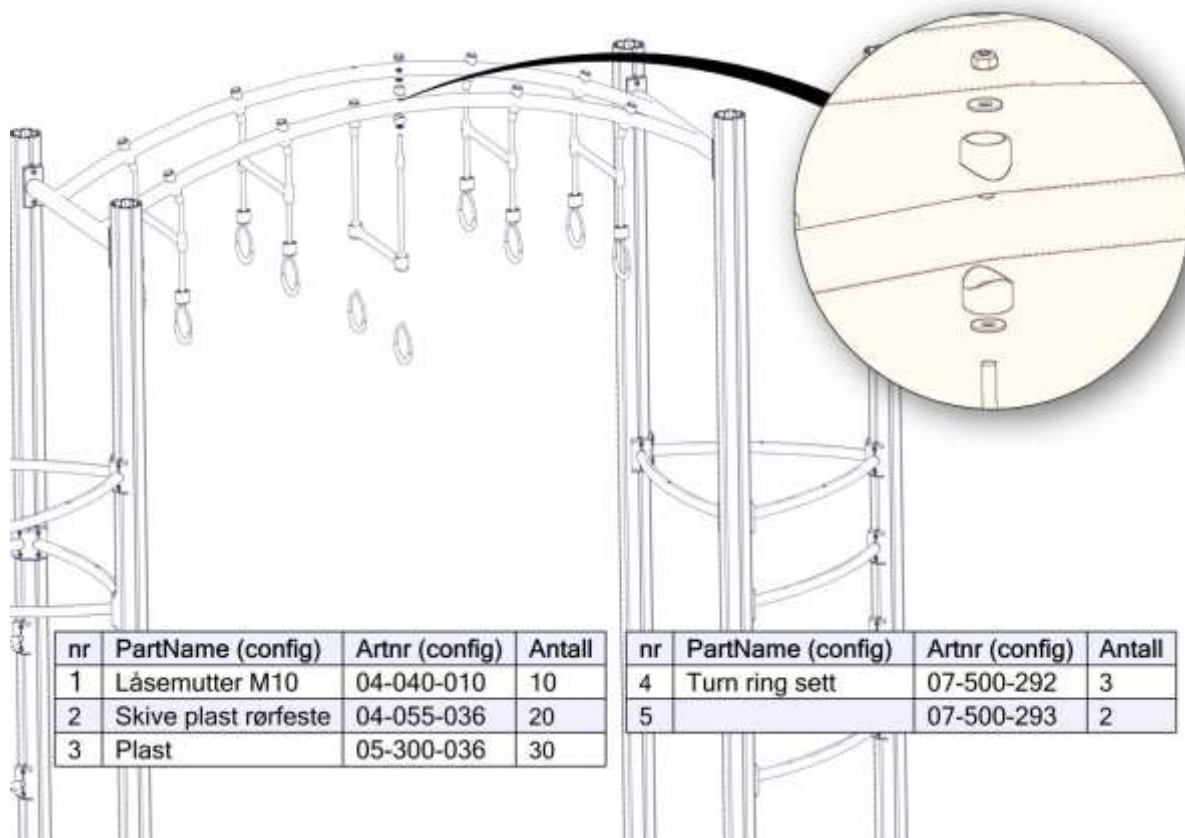

nr	PartName (config)	Artnr (config)	Antall
1	Låsemutter M10	04-040-010	10
2	Skive plast rørfeste	04-055-036	20
3	Plast	05-300-036	30

nr	PartName (config)	Artnr (config)	Antall
4	Turn ring sett	07-500-292	3
5		07-500-293	2

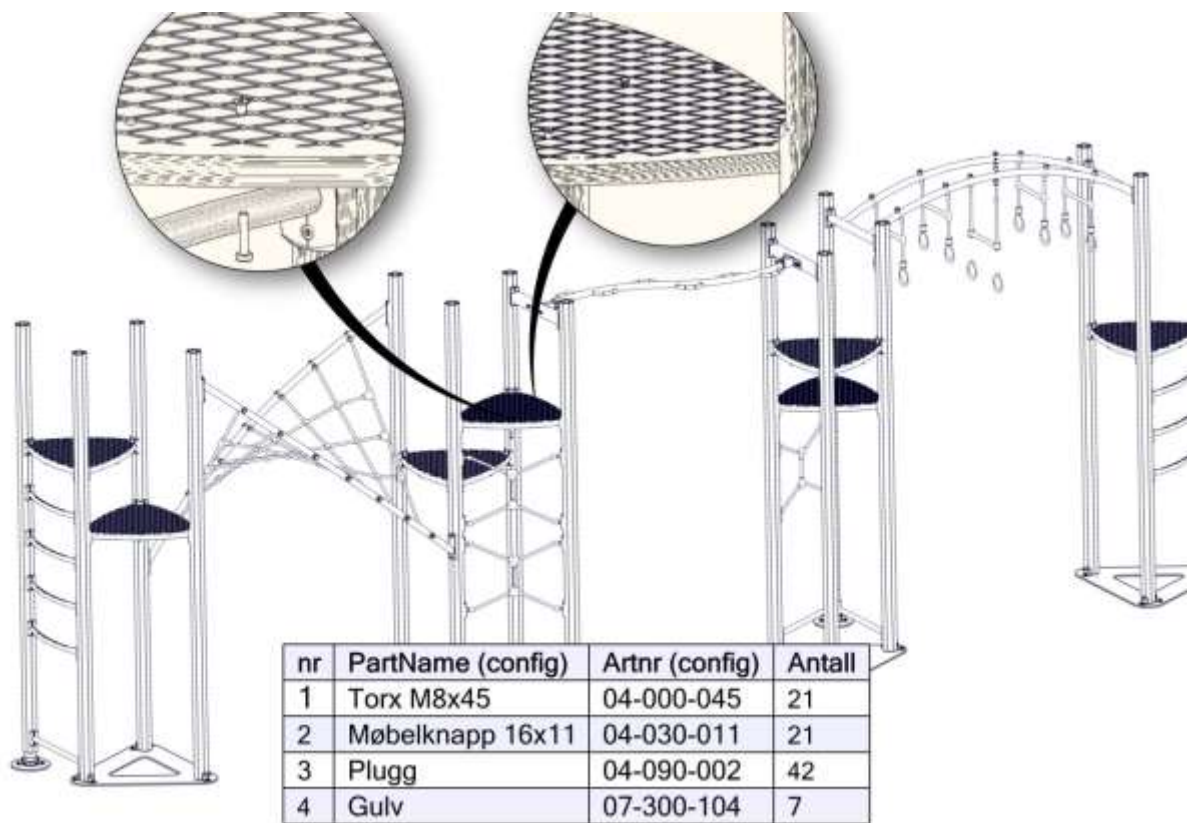

nr	PartName (config)	Artnr (config)	Antall
1	Torx M8x45	04-000-045	21
2	Møbelknapp 16x11	04-030-011	21
3	Plugg	04-090-002	42
4	Gulv	07-300-104	7

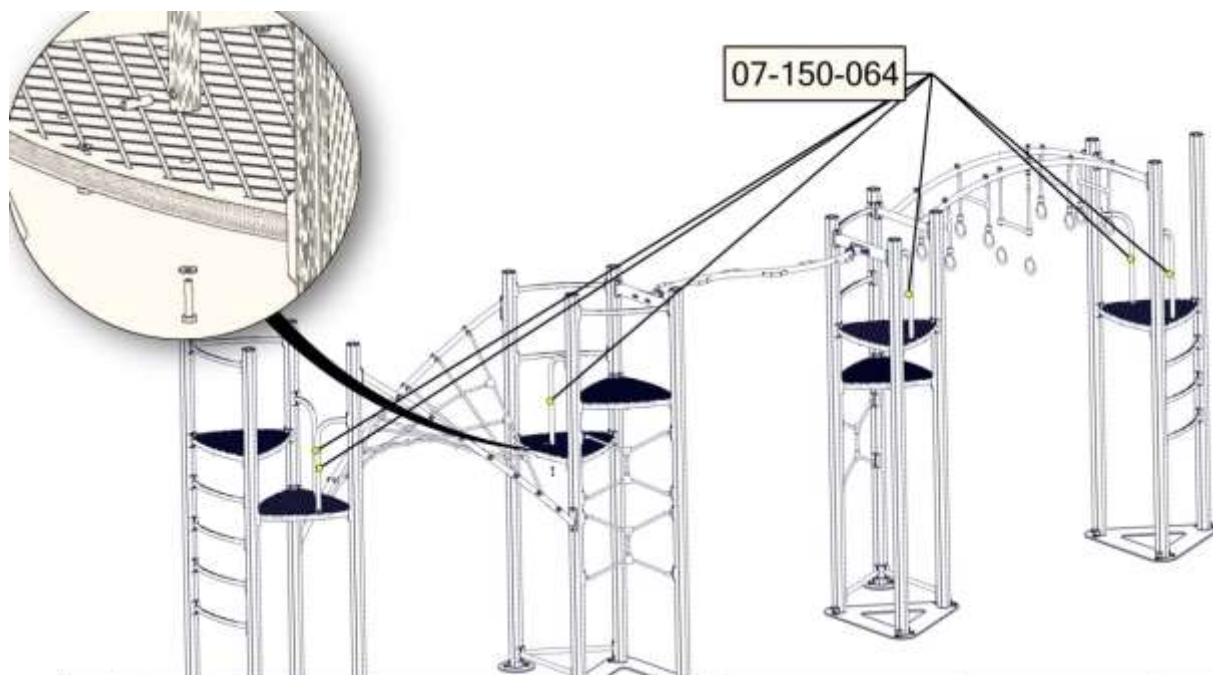
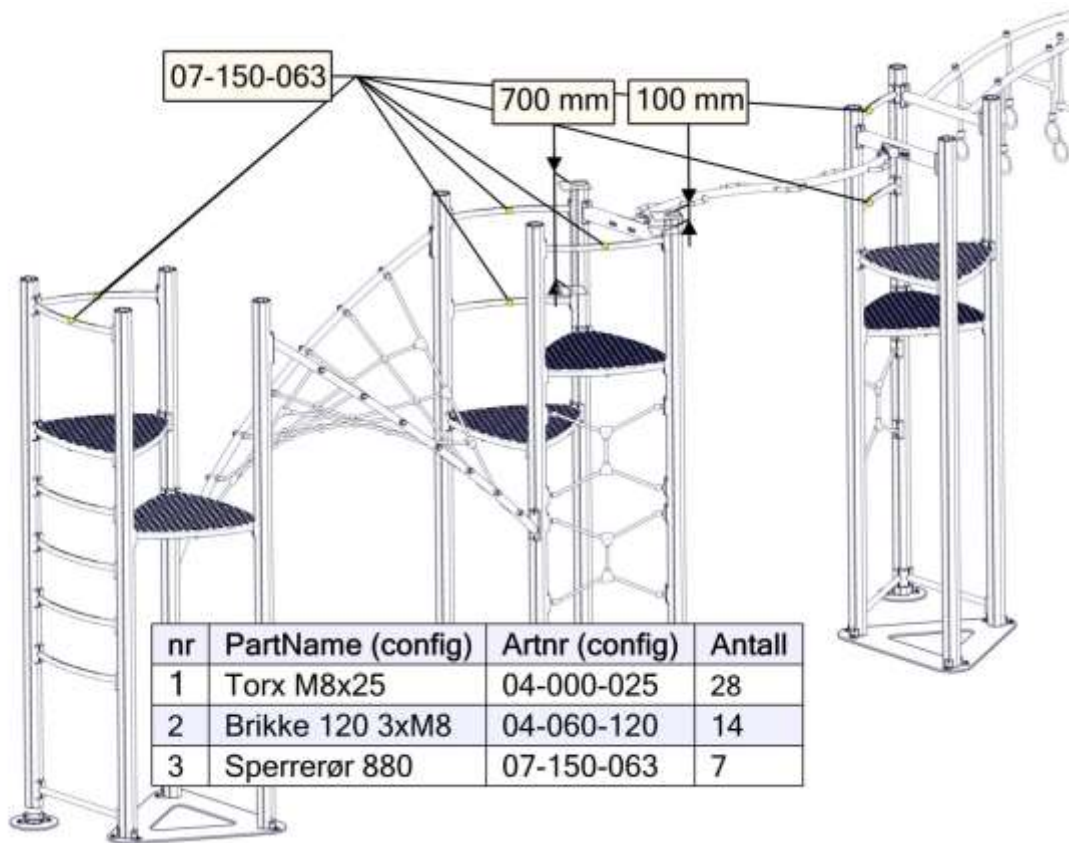

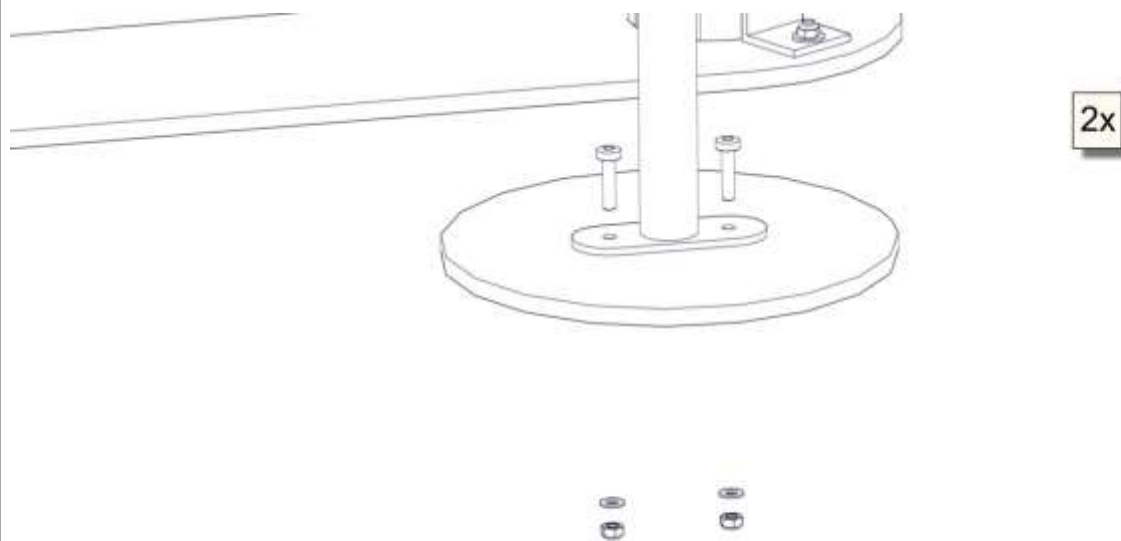
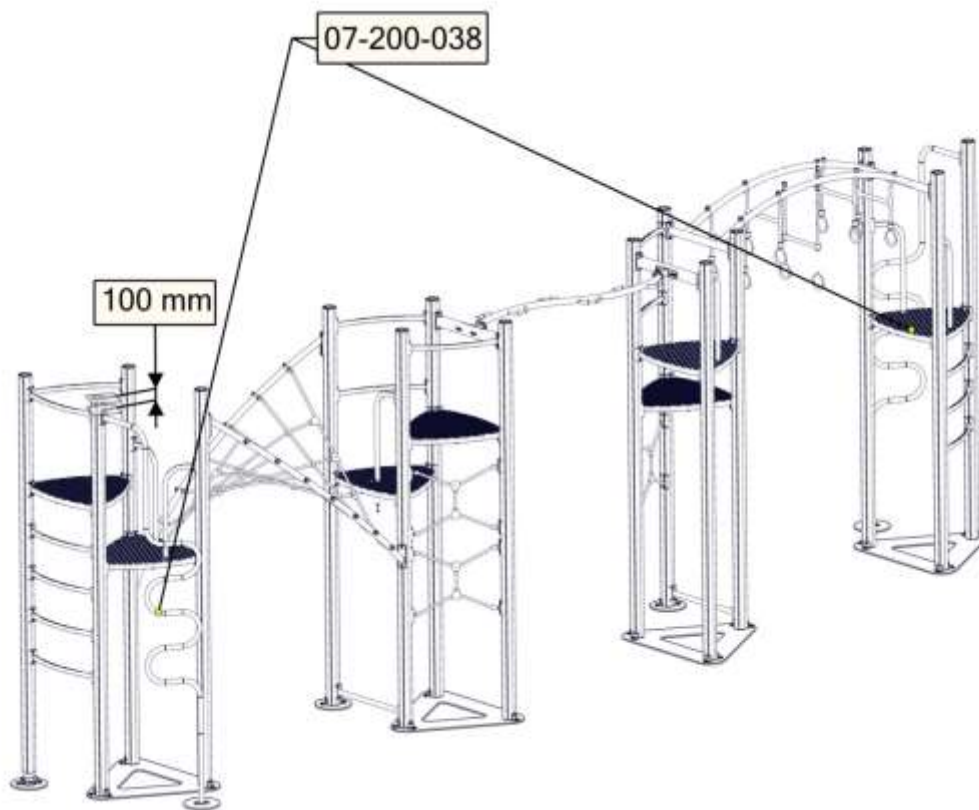

nr	PartName (config)	Artnr (config)	Antall
2	Torx M8x35	04-000-035	2
3	Låsemutter M8	04-040-008	2
4	Skive M8	04-050-008	2
5	S-oppgang	07-200-038	1



2x

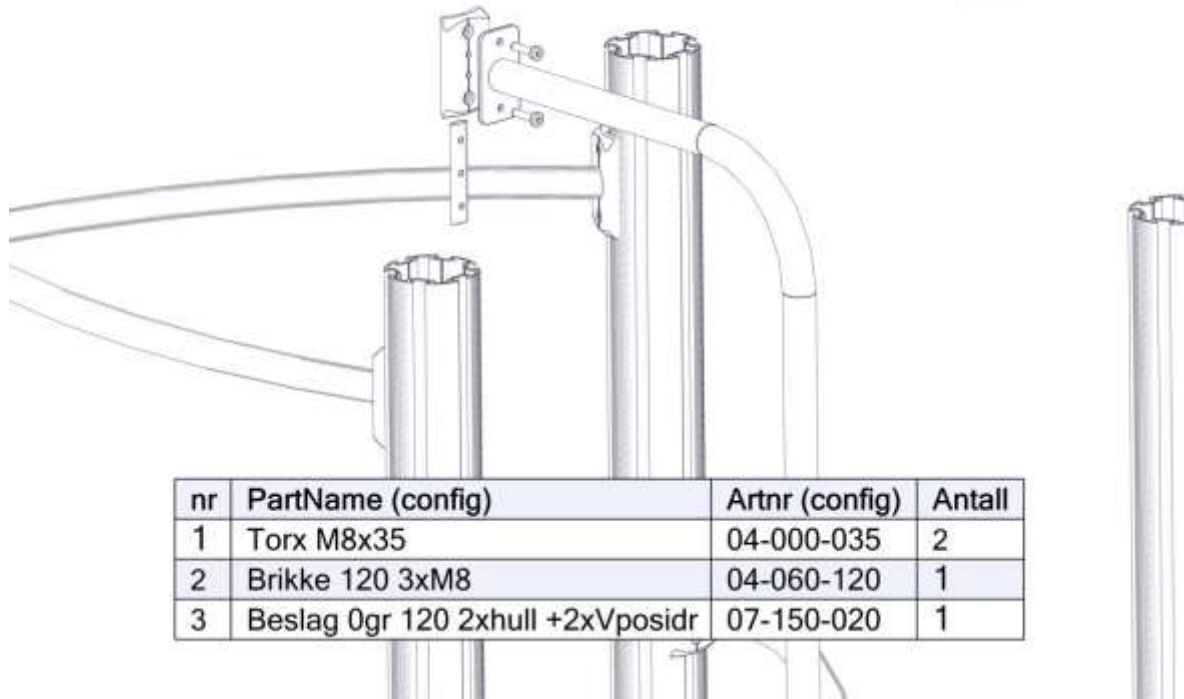

nr	PartName (config)	Artnr (config)	Antall
1	Torx M8x35	04-000-035	2
2	Brikke 120 3xM8	04-060-120	1
3	Beslag 0gr 120 2xhull +2xVposidr	07-150-020	1

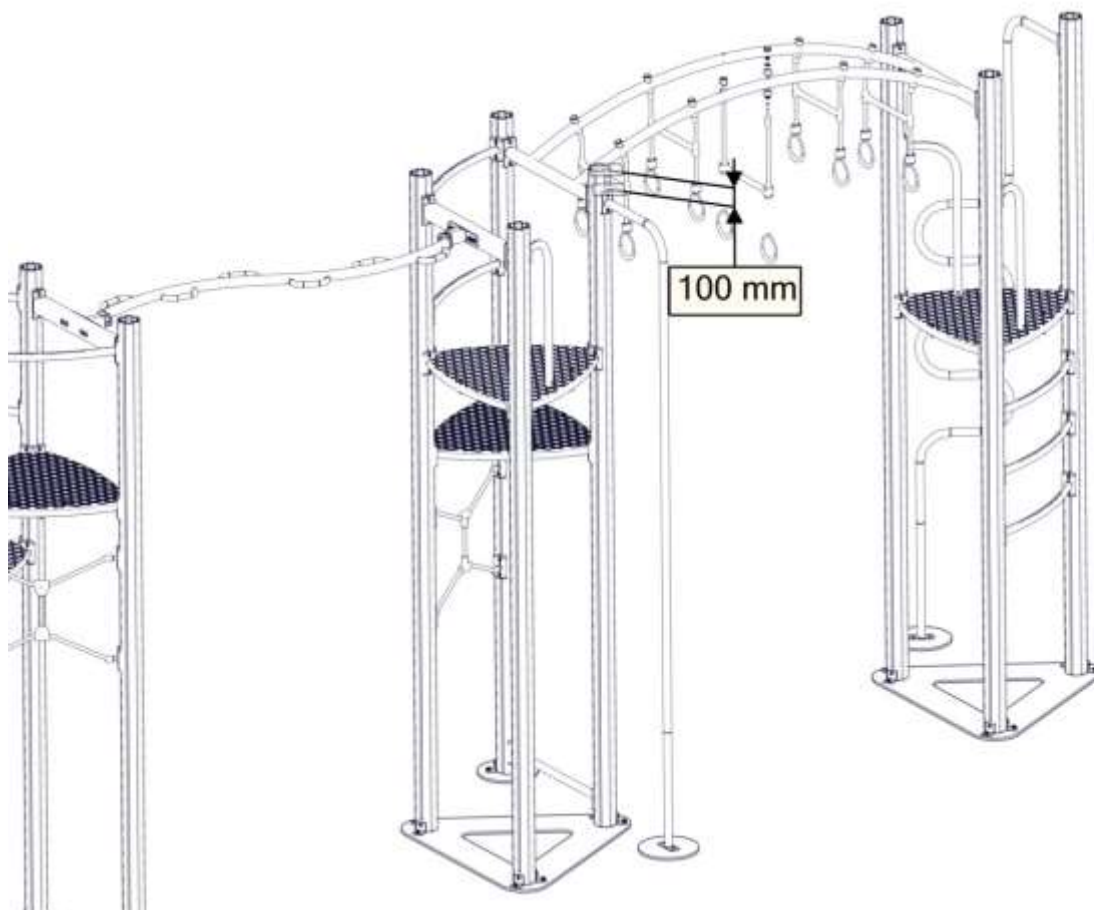

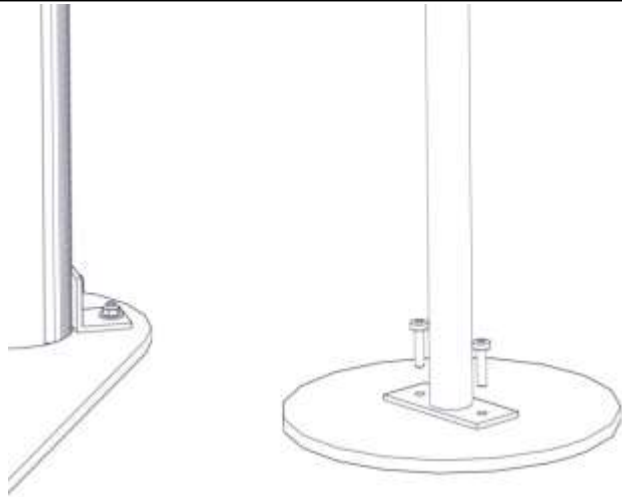

nr	PartName (config)	Artnr (config)	Antall
2	Torx M8x35	04-000-035	2
3	Låsemutter M8	04-040-008	2
4	Skive M8	04-050-008	2
5	Brannstang	07-200-037	1

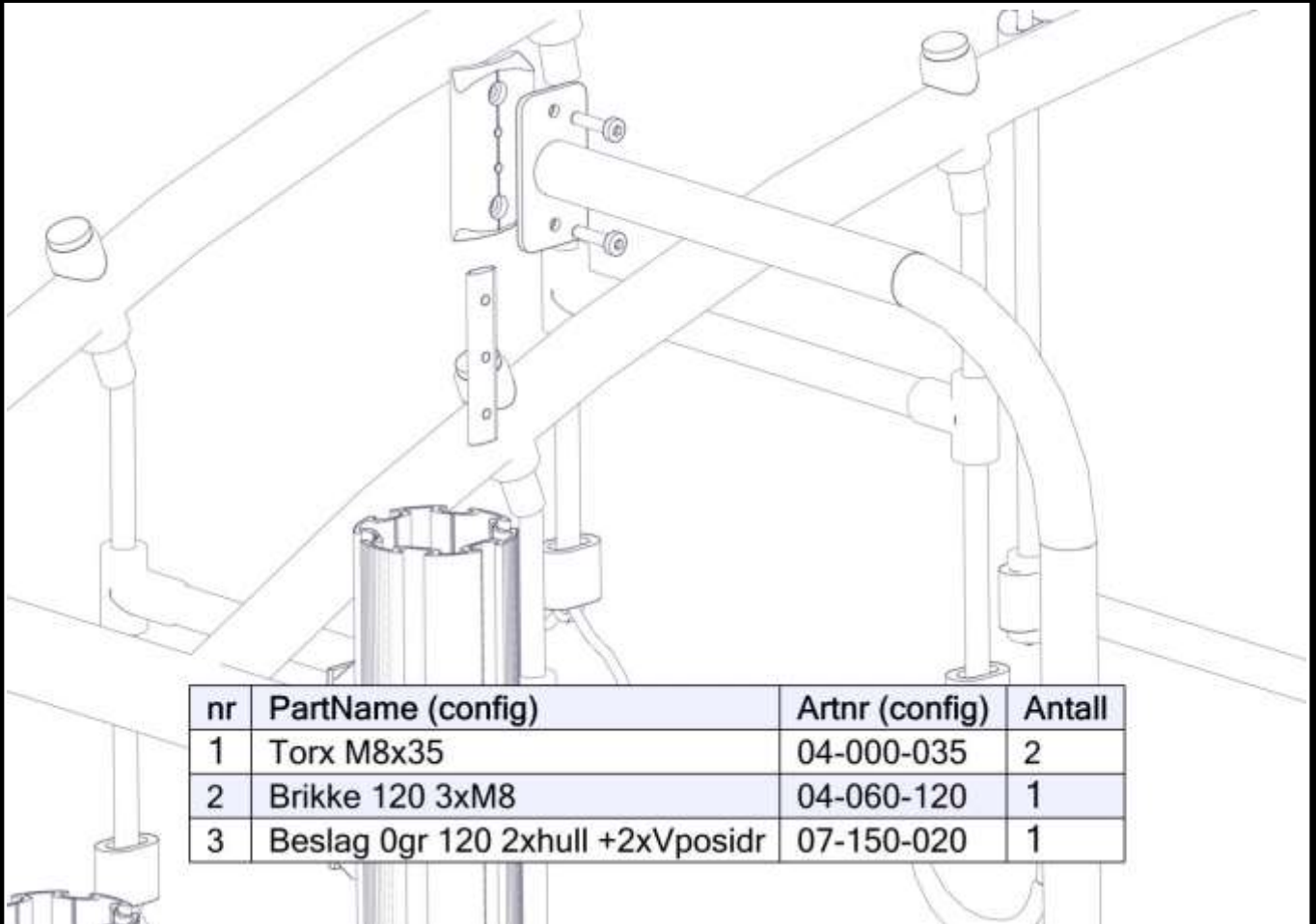



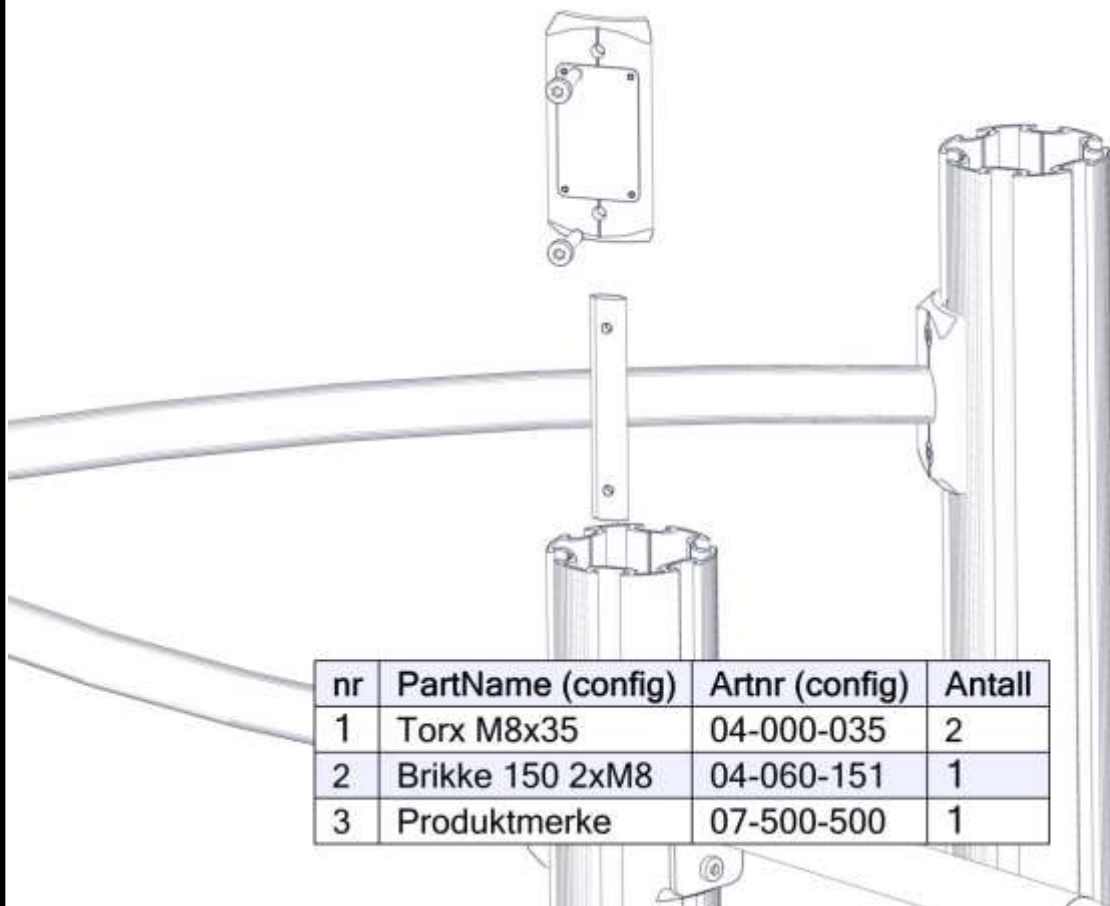
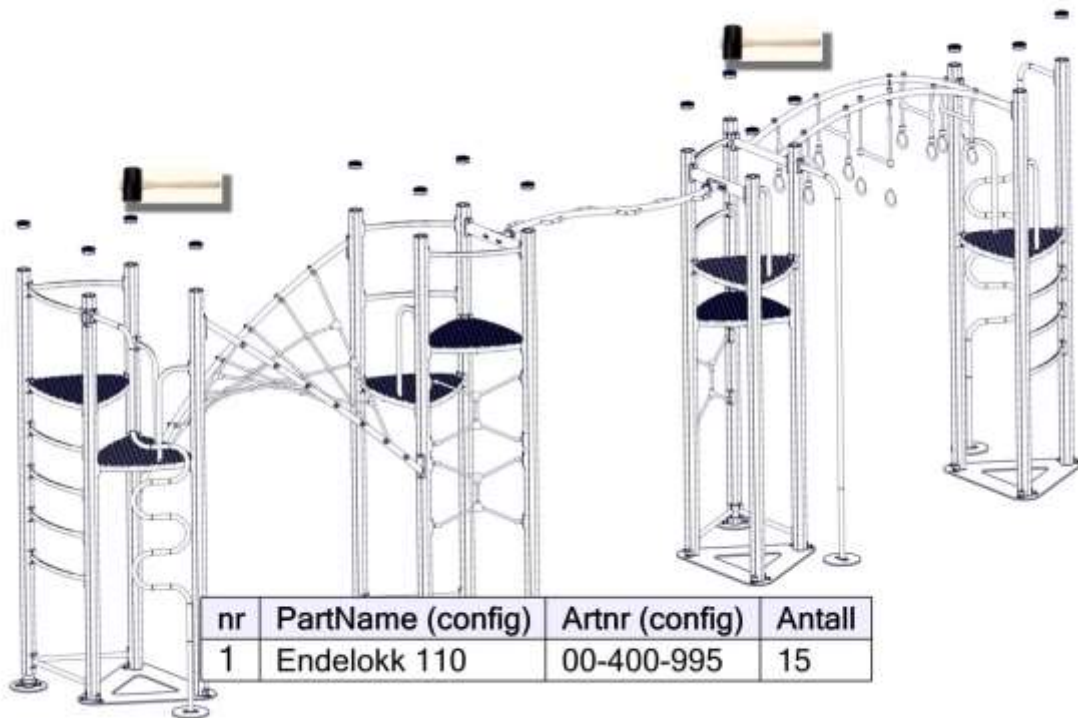









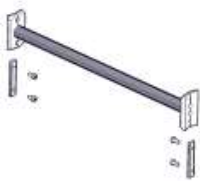









nr	PartName (config)	Artnr (config)	Antall
1	Torx M8x35	04-000-035	2
2	Brikke 120 3xM8	04-060-120	1
3	Beslag 0gr 120 2xhull +2xVposidr	07-150-020	1



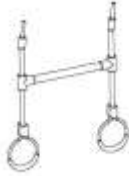



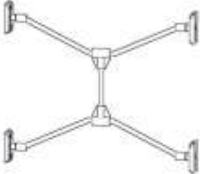





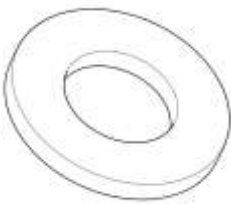

<b>Før utstyret tas i bruk / Before play begins / Innan lekredskapet tas i bruk</b>	
<b>N</b>	<ul style="list-style-type: none"> <li>● Påse at fallunderlag er utlagt i henhold til gjeldende regler eller vår anbefaling</li> <li>● Fjern alle monteringshjelpemidler ( rester av betong, planker, paller, plast, og lignende)</li> <li>● Før utstyret tas i bruk, burde man sjekke at det ikke er fare for at anorakksnorer og lignende som kan hekte seg fast noen steder på lekeapparatet. (Vedlagte snor med dobbe (kneledd) kan brukes til å sjekke at dette er i orden. Se vedlagte veiledning for bruk av denne. Dette gjøres for å oppdage eventuelle feilmonteringer.?)</li> <li>● NB! Bør stå i 2-3 dager før bruk</li> </ul>
<b>EN</b>	<ul style="list-style-type: none"> <li>● Make sure the area and depth of safer surfacing are according to the current standard, or to the manufacturer's recommendation</li> <li>● Make sure all tools and surplus materials are removed before play begins</li> <li>● PS! When complete, allow 2-3 days for the concrete to set before use</li> </ul>
<b>S</b>	<ul style="list-style-type: none"> <li>● Kontrollera att fallunderlag är utlagt enligt gällande regler eller vårt rekommendation</li> <li>● Ta bort alla monteringshjälpmedel (rester av betong, plankor, pallar, plast och liknande)</li> <li>● Innan lekredskapet används, kontrollera att anoracksnoddar eller kläder/delar av kläder eller liknande inte kan fastna i några delar på redskapet. (Den bipackade "knävringen" kan man med fördel användas för denna kontroll.</li> <li>● Detta görs för att upptäcka eventuella felmonteringar.)</li> </ul>

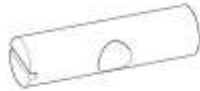

<b>komponenter</b>		Sign. _____.	
	Stolpe L=3450 15 07-100-334		Endelokk 15 04-400-100
	Sluse 6 07-150-064		Sperrerør 14 07-150-060
	Sperrerør rett 3 07-150-062		Sperrerør gulv 21 07-150-061
	Fundament 3 4 07-400-003		Fundament 1 3 07-400-001
	S-Treppe 2 07-200-028		Brannstang 1 07-200-037
	Gulv 7 07-300-101		Tordert nett 1 07-500-302
	Fundamentplate 3 00-003-009		Rør tordert nett 2 07-500-301

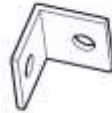
<b>komponenter</b>		Sign. _____.	
	Dobbelt ringer bro 07-500-291	1	
			
			0Gr_150_2H 8 07-150-022
			
			0gr_120_2H 3 07-150-020
	Ringer 07-500-292	5	
			
			0gr_200_2H 4 07-150-023
	Mellomdel Armgang 07-500-282	2	
			
			Armgang 1 07-500-281
		3	
			
			Produktmerke 1 PÅ 0gr 150 be- slag

<b>komponenter</b>		Sign. _____			
	Torx M8x25 04-000-025	<b>194</b>		Brikke 50-1T 04-060-050	<b>30</b>
	Torx M8x30 04-000-030	<b>30</b>		Brikke 120-3T 04-060-120	<b>75</b>
	Torx M8x35 04-000-035	<b>38</b>		Brikke 150-2T 04-060-151	<b>9</b>
	Torx M8x45 04-000-045	<b>47</b>		Brikke 200-2T 04-060-200	<b>4</b>
	Skive M8 04-050-008	<b>66</b>		Låsemutter M8 04-040-008	<b>36</b>
	04-055-008	<b>6</b>		Låsemutter M10 04-040-010	<b>36</b>
	Skive M10 04-050-010	<b>8</b>		Umbrako-B M10x100	<b>8</b>
	Skive M10 Poly 04-055-036	<b>48</b>		04-036-100	
	Skive M10 04-055-010	<b>16</b>		Hylsemutter M8 12-38 04-018-060	<b>6</b>
	Møbelknapp M8x13x17 04-030-011	<b>21</b>			
	Plast rondell 05-300-036	<b>24</b>		Plast rondell 05-300-036	<b>48</b>
	Plast plug 9-11mm 04-090-002	<b>42</b>			M12x20 seks- kant 07-012-020
					Vinkel 50x50x50 04-070-050 11mm
					Bit Torx TX45 04-001-045