

N

Monteringsanvisning

EN

Assembly Instructions

S

Monteringsanvisning

Produkt nr. / Product no. / Produkt nr.

14-100-019

Ord. nr. _____

Dato. _____

Sign. _____

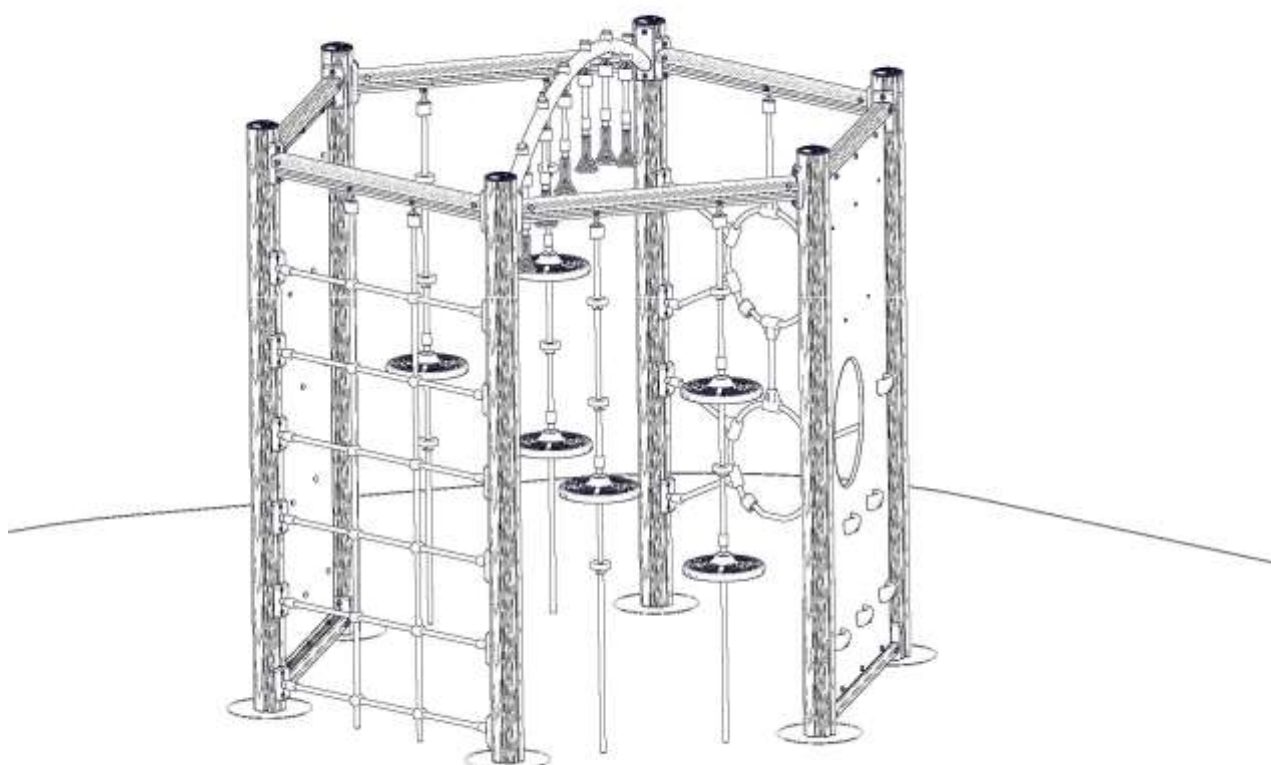
**sove**

Søve AS
3830 Ulefoss - Norway
Tlf: +47 35 94 65 65
www.sove.no



Søve AB
EA Rosengrensgratan 32
421 31 Västra Frölunda
Phone: +46 (0)31 773 97 00
www.sove.se

Monteringstips / Assembly Advice / Monteringsstips

N

- Les monteringsanvisningen nøye før montering.
- Monter elementene i rekkefølgen som vist.
- Boltene bør ikke skrues for hardt til før alt er montert, vatret og loddet. Skru så boltene til.
- NB! Ved bruk av drill, kan boltene ryke.
- Er lekeutstyret plassert i naturlige ferdselstraséer må området sikres mot gjennomgang.
- Innspringningshinder bør vurderes rundt lekeapparater hvor det er stor bevegelse, f.eks. ved huskestativ.
- Det bør være fritt innsyn til lekeutstyr som er beregnet for barn under 3 år.

NB! Under monteringsarbeidet må utstyr, som ikke er forankret forsvarlig i bakken, sikres slik at det ikke velte.

Området må avstenges under montering av apparatene med sperrebånd eller lignende.

EN

- Read the instruction carefully before assembling the play unit..
- Assemble the components in the sequence shown in these instructions.
- Fixings must not be fully tightened during assembly. Before casting the foundations, the structure must be level and plumb, at which point all fixings are tightened.
- PS! If use of drill, the bolts may be wrecked.
- Secure the construction-area to prevent people from walking through it.
- Consider installing barriers around play-equipment which gives rise to a lot of activity – i.e.swings.
- Ensure that clear vision is possible across the play area so that supervision is possible from any position, particularly where children under 3 years of age will be playing.

NB! During assembly of the equipment, ensure that all structures are securely propped, especially when left overnight. Also ensure that equipment is supported whilst concrete foundations are setting and enclose the area securely to prevent access.

Monteringstips / Assembly Advice / Monteringsstips

S

- Läs monteringsanvisningen noga före montering.
- Montera delarna i den ordningen som anvisas
- Skruvarna bör inte skruvas för hårt tills allt är monterat, i våg och lodat.









OBS! Används elektrisk skruvdragare, kan bulten gå sönder. Hårdra därför manuellt!

- Om lekplatsen placeras vid en gångväg mm bör området säkras mot genomfart av gående och cyklister.
- Inspringningshinder bör placeras runt lekutrustning med stor rörelse, t ex, gungställning.
- Det bör vara fri insyn till lekutrustning beräknat till barn under 3 år.

OBS! Under monteringsarbete bör utrustningen som inte ska förankras i marken, ställs så att den inte kan välta.

Området måste spärras när lekutrustningen byggs upp, med avspärrningsband eller liknande.

Nødvendig verktøy / Tools required / Nödvändiga verktyg

<p>(N)</p> <p>(EN)</p> <p>(S)</p>	<p>(A)</p> 	<p>(B)</p>  <p>Torx Nr 45 High quality</p>	<p>(C)</p>	<p>(D)</p> 	<p>(E)</p> 
		<p>Metermål</p> <p>Metric measure</p> <p>Tumstock</p> 	<p>16 V</p> 	<p>Merkebånd</p> <p>Mark ribbon</p> <p>Märkeband</p> 	

Nødvendig antall personer / Number of persons required / Rekommenderad antal personer

<p>(N)</p> <p>(EN)</p> <p>(S)</p>	
-----------------------------------	---

Anbefalt arealbehov ved montering / Recommended working space / Rekommenderad arealbehov vid montering

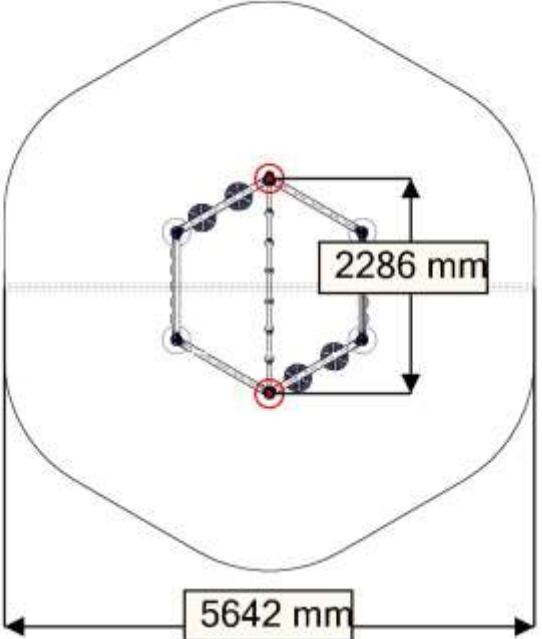
<p>(N)</p> <p>(EN)</p> <p>(S)</p>	
-----------------------------------	---











Boltepakker for / Boltpackage for / Boltpaket för

Sign. _____

Stolpe 110	Ant= 4	Navn	Artnr/dimensjon	Ant	Lev
		Stolpe 110 L=2700 600-2100 (6)	07-100-327	6	
Stolpende	Ant= 4	Navn	Artnr/dimensjon	Ant	Lev
		End lokk (1)	00-400-995	6	
Fundament	Ant= 6	Navn	Artnr/dimensjon	Ant	Lev
		Funplate (1)	07-400-011	6	
		Vinkel 50x50x4 11mm (2)	04-070-050	12	
		Brikke 50 (2)	04-060-050	12	
		Torx M8x25 (2) Torx M8x30 (2)	04-000-025 04-000-030	12 12	
		Skive M8 (4)	04-055-008	24	
		Mutter M8 (2)	04-040-008	12	
Produktmerke	Ant= 1	Navn	Artnr/dimensjon	Ant	Lev
		Ogr 150_2H (2) Med Produktmerke	????	1	
		Brikke 150_2T(2)	04-060-150	1	
		Torx M8x35 (2)	04-000-035	2	









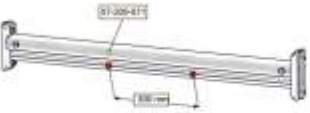

Boltepakker for / Boltpackage for / Bultpaket för

Sign. _____

Armgang	Ant= 1	Navn	Artnr/dimensjon	Ant	Lev
		Rør boye300 (1)	07-200-013	1	
		0gr_200_2H (2)	07-150-023	2	
		Brikke 200(2)	04-060-200	2	
		Torx M8x35 (4)	04-000-035	4	
		Handtak (6)	07-500-022	6	
		Sekskant M8x70 (6)	07-008-070	6	
		SkiveCovered (12)	04-055-036	12	
		Rørdel (12)	04-055-036	12	
		Rørdel-end(6)	04-055-036	6	

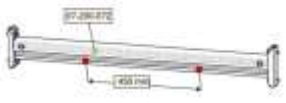
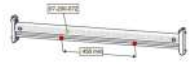















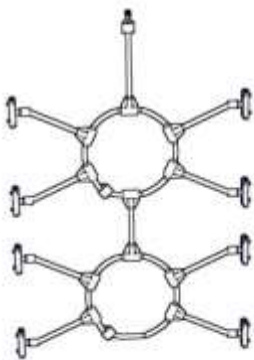

Boltepakker for / Boltpackage for / Bultpaket för

Sign. _____

Drager med 0gr beslag 1 hull	Ant= 1	Navn	Artnr/dimensjon	Ant	Lev
		Drager inkl 0gr beslag (1) Med 1 hull	07-500-370	1	
		Brikke 150_2T (2)	04-060-151	2	
		Torx M8x35 (4)	04-000-035	4	
Drager med 0gr beslag 2H 300	Ant= 1	Navn	Artnr/dimensjon	Ant	Lev
		Drager inkl 0gr beslag (1) Med 2 hull	07-500-371	1	
		Brikke 150_2T (2)	04-060-151	2	
		Torx M8x35 (4)	04-000-035	4	
Drager med 0gr beslag 2H 450	Ant= 2	Navn	Artnr/dimensjon	Ant	Lev
		Drager inkl 0gr beslag (1) Med 2 hull	07-500-372	2	
		Brikke 150_2T (2)	04-060-151	4	
		Torx M8x35 (4)	04-000-035	8	
Drager med 0gr beslag 3 Hull hoh300	Ant= 4	Navn	Artnr/dimensjon	Ant	Lev
		Drager inkl 0gr beslag (1) Med 3 hull	07-500-373	4	
		Brikke 150_2T (2)	04-060-151	8	
		Torx M8x35 (4)	04-000-035	16	











Boltepakker for / Boltpackage for / Bultpaket för

Sign. _____.

Klatrenett	Ant= 1	Navn	Artnr/dimensjon	Ant	Lev
		Klatrenett	07-500-080	1	
		Brikke 120_2T (12)	04-060-151	12	
		Torx M8x25 (26)	04-000-025	26	
		Ogr 120 2H_1V10 (12)	07-150-024	12	
		Umbrako M10x20 (12)	04-037-020	12	
		Loctite		1	
		Skive M8 (2)	04-055-008	2	
		Mutter M8 (4)	04-040-008	4	
		Fundamentplate (2)	00-003-106	2	
Klatre-spidernett	Ant= 1	Navn	Artnr/dimensjon	Ant	Lev
		Klatrenett (1)	07-500-081	1	
		Brikke 120_2T (8)	04-060-151	8	
		Torx M8x25 (17)	04-000-025	17	
		Ogr 120 2H_1V10 (8)	07-150-024	8	
		Umbrako M10x20 (8)	04-037-020	8	
		Loctite		1	
		Mutter M8 (1)	04-040-008	1	
		Skive m8 (1)	04-050-008		

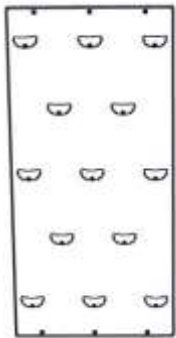
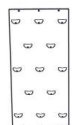
Boltepakker for / Boltpackage for / Bultpaket för

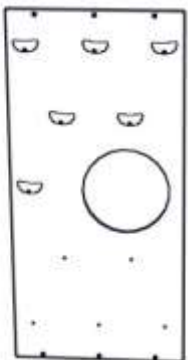
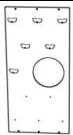
Sign. _____

Monkey Sett	Ant= 2	Navn	Artnr/dimensjon	Ant	Lev
		monkeysett (2)	07-500-082	2	
		Torx M8x25 (2)	04-000-025	4	
		Fundamentplate (2)	00-003-106	4	
		Skive M8 (4)	04-055-008	8	
		Mutter M8 (4)	04-040-008	8	
Klatrevegg	Ant= 1	Navn	Artnr/dimensjon	Ant	Lev
		Klatreplate (1)	07-500-084	1	
		Torx M8x30 (6)	04-000-030	6	
		Mutter M8 (6)	04-040-008	6	
Klatrevegg med hull	Ant= 1	Navn	Artnr/dimensjon	Ant	Lev
		Klatreplate (1)	07-500-083	1	
		Torx M8x30 (6)	04-000-030	6	
		Mutter M8 (6)	04-040-008	6	

Fundamentering med betong / Foundation concrete / Förankring med betong

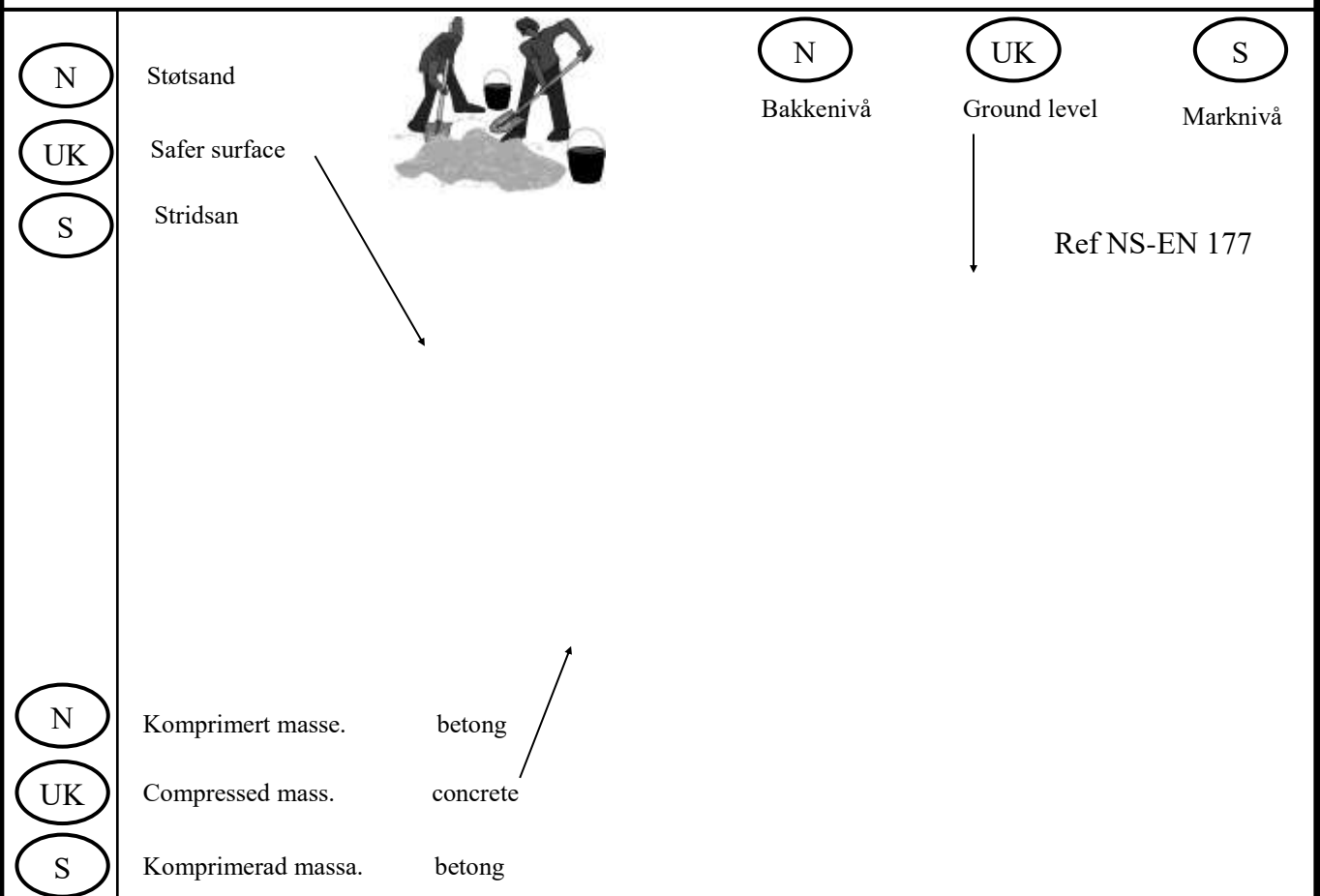

Fundamentering uten betong / Foundation without concrete / Förankring utan betong

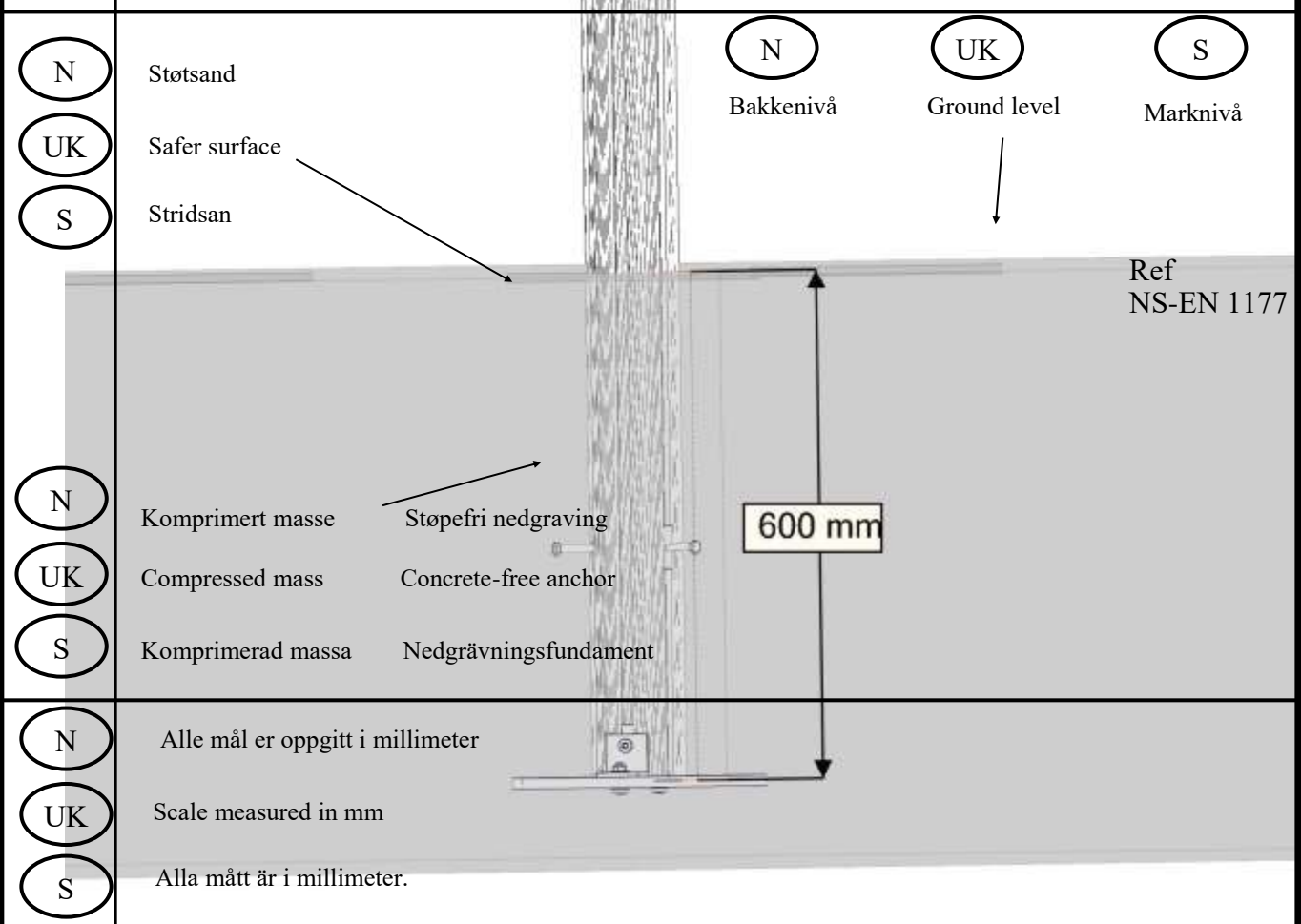

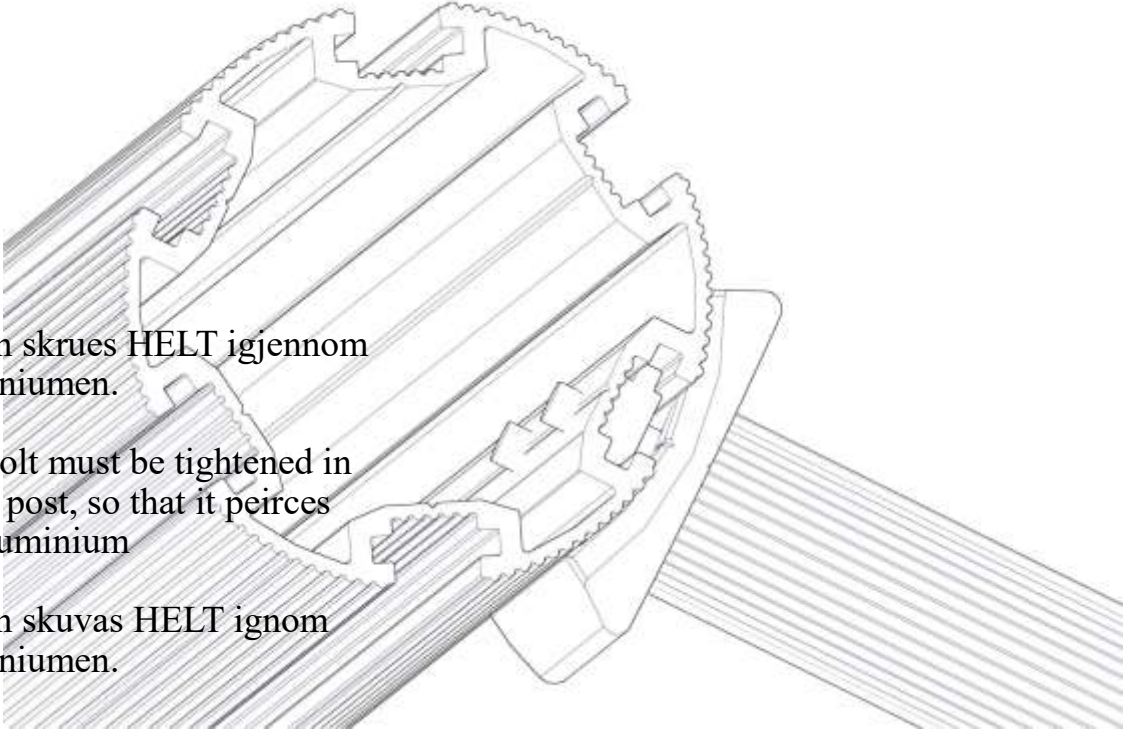
<p>(N) Bolten skrues HELT igjennom aluminiumen.</p> <p>(UK) The bolt must be tightened in to the post, so that it peirces the aluminium</p> <p>(S) Bulten skivas HELT ignom aluminiumen.</p>	

Fallhøyder / Free height of fall / Fallhöjder

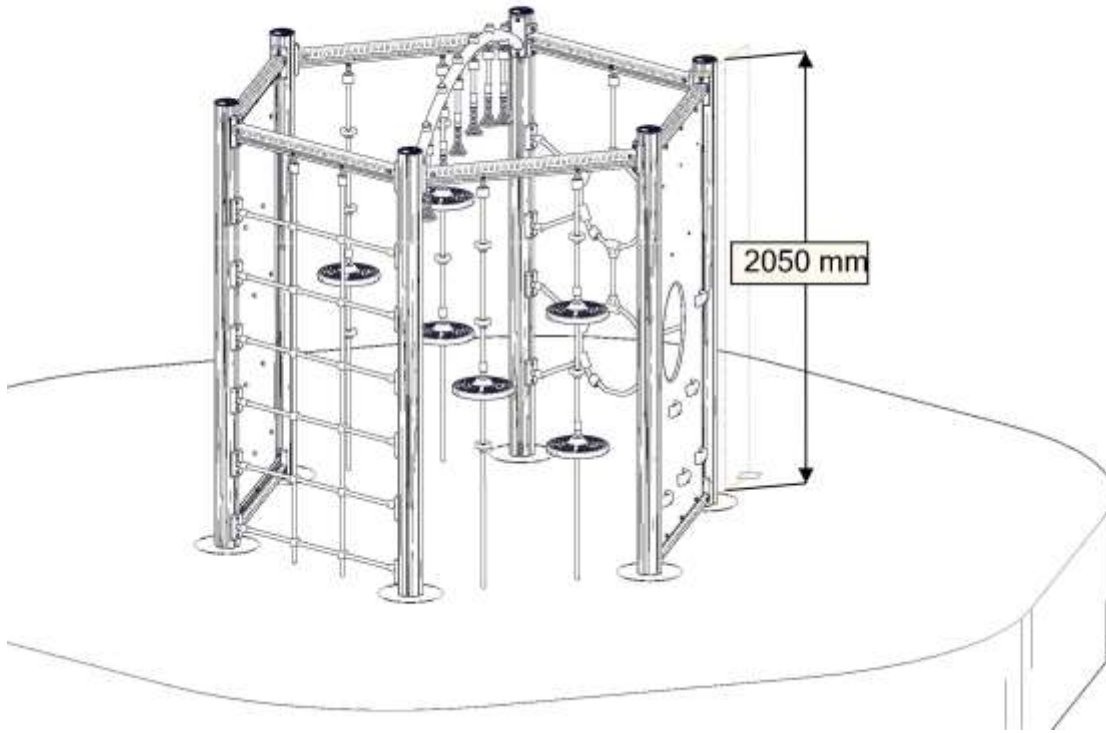

Sikkerhetszone / Safety zone / Säkerhetszon

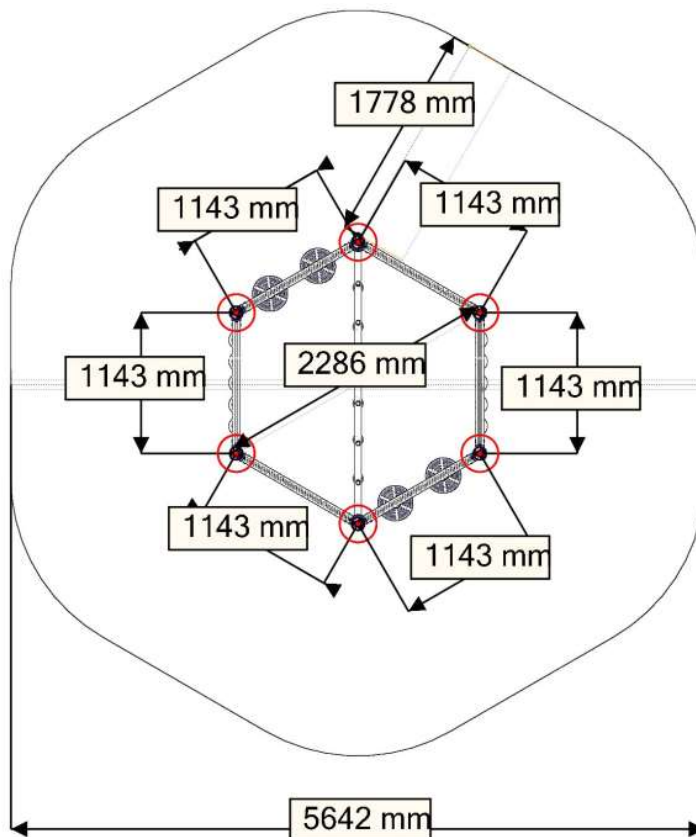

Plassering av forankringer / Ground plan / Placering av förankringar

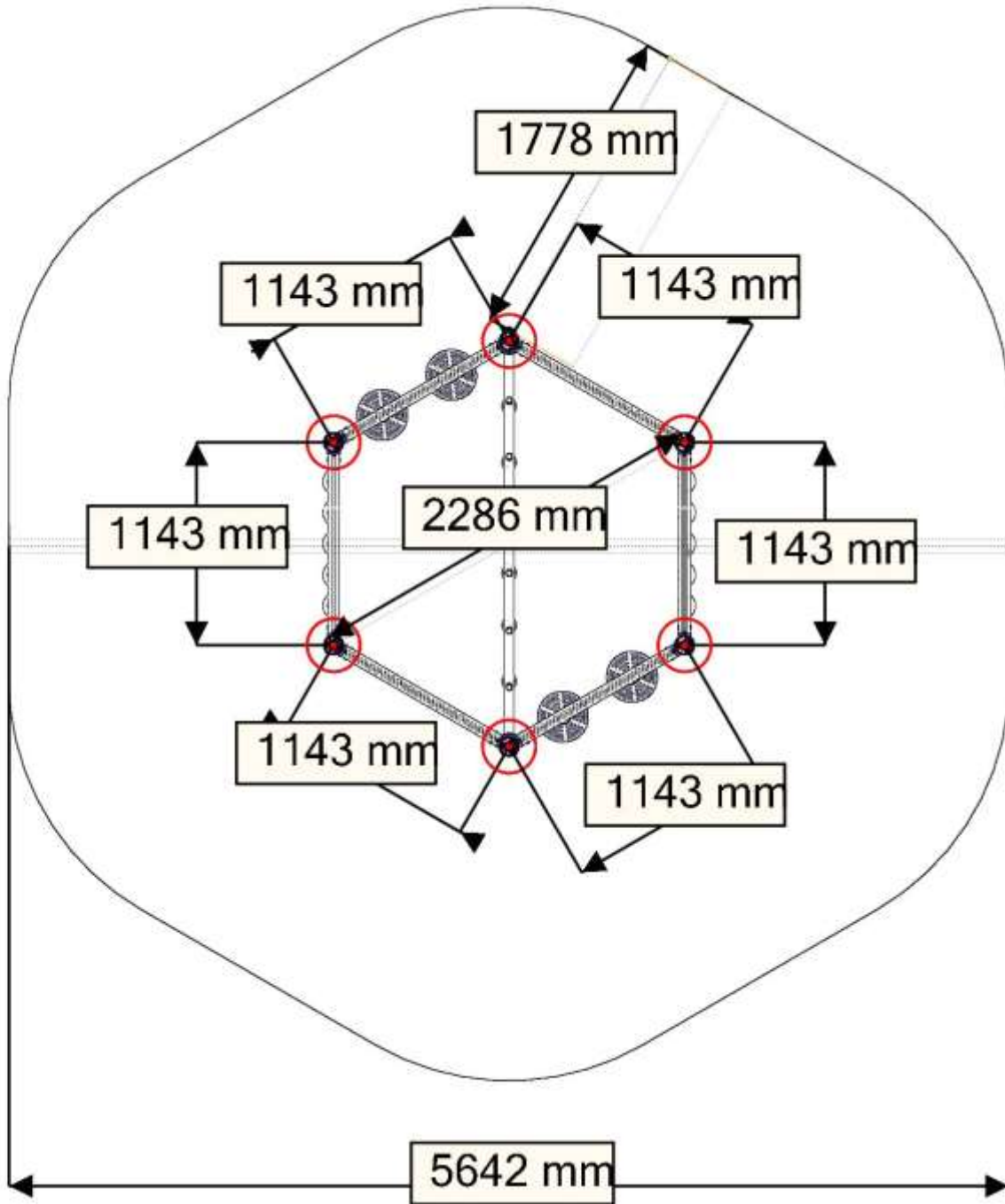

N

Alle mål er oppgitt i millimeter

UK

Scale measured in mm

S

Alla mått är i millimeter.

Montering av lekeapparatet / Assembly instructions / Montering av lekredskapet

6x

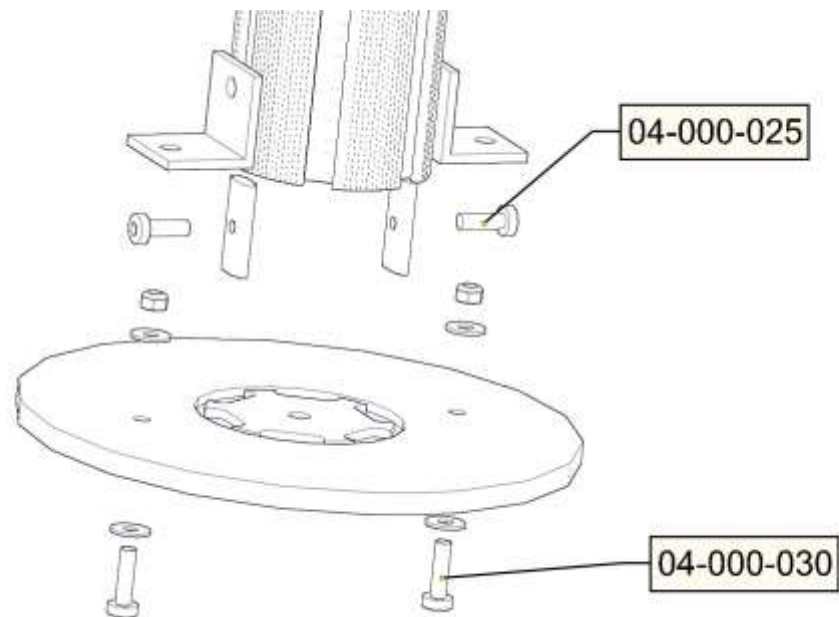

BOM ID	Name	SW Configuration	Artnr (config)	Qty
1	TorxM8-1	TXM8x25	04-000-025	2
2	TorxM8-2	TXM8x30	04-000-030	2
3	mutter M8-1	M8_Borg	04-040-008	2
4	Skive-	M8_stor	04-055-008	4
5	brikke SFA5116-1	50_1T	04-060-050	2
7	6SP110 74569-0-1	2100-600	07-100-334	1
8	fundament eenkant-1	Default	07-400-011	1

6x

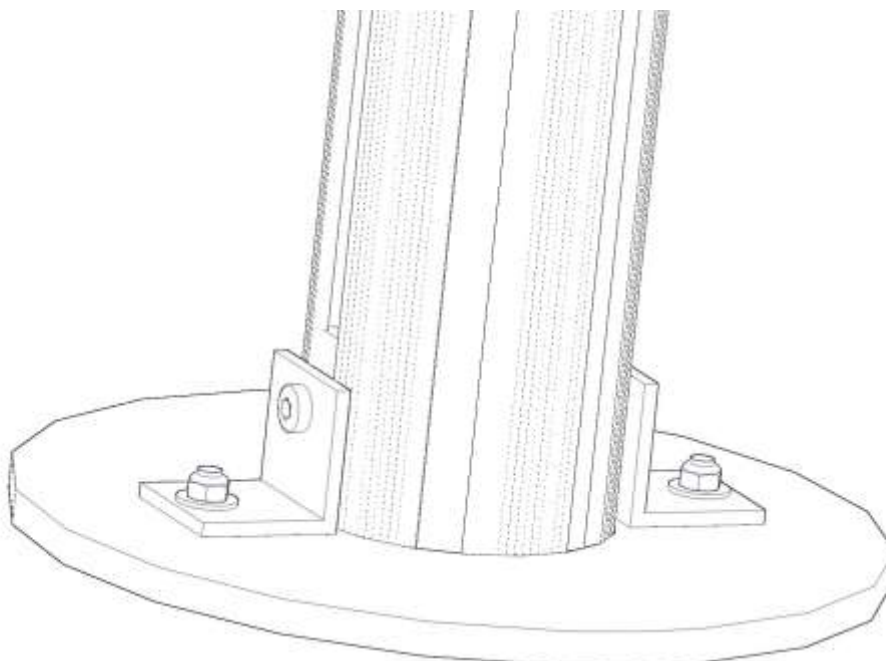

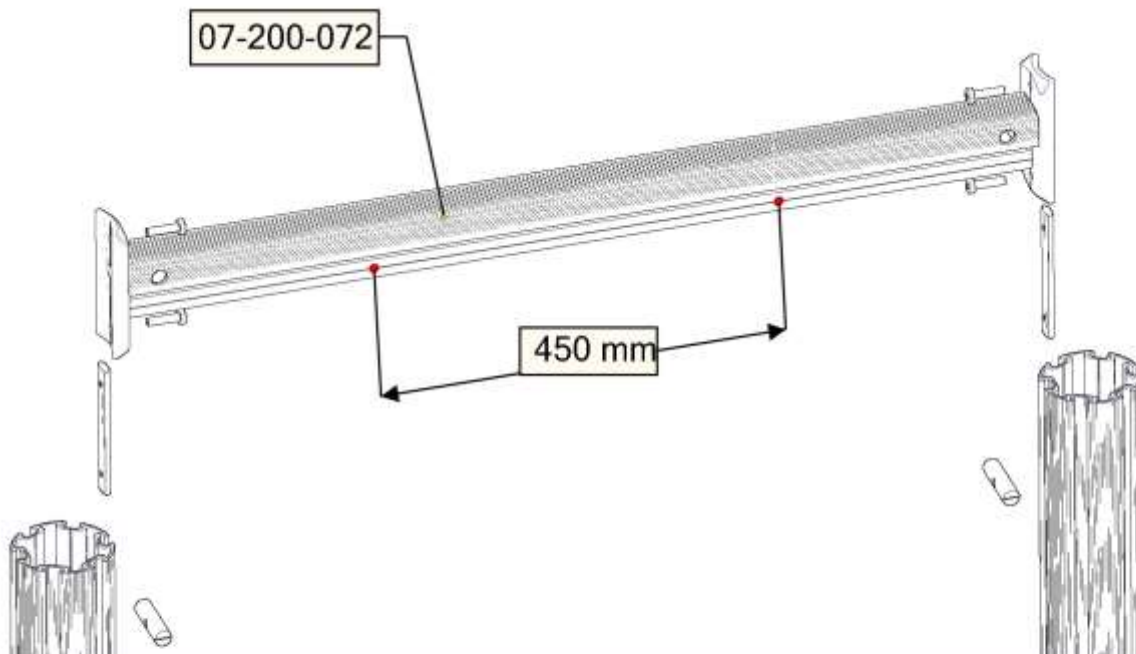
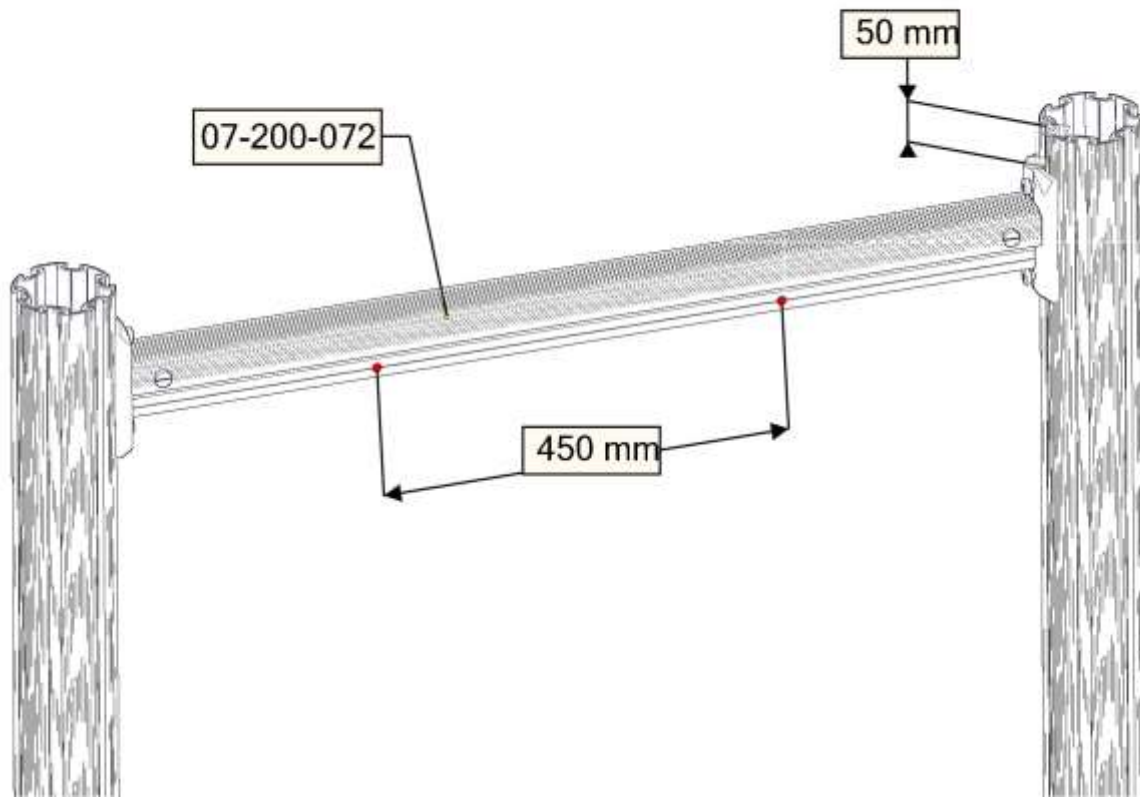

BOM ID	Name	SW Configuration	Artnr (config)	Qty
1	TorxM8-	TXM8x35	04-000-035	4
2	brikke_SFA5116-1	150_2T	04-060-151	2
3	SFA_5104_6sp-1	1143_2H450	07-200-072	1

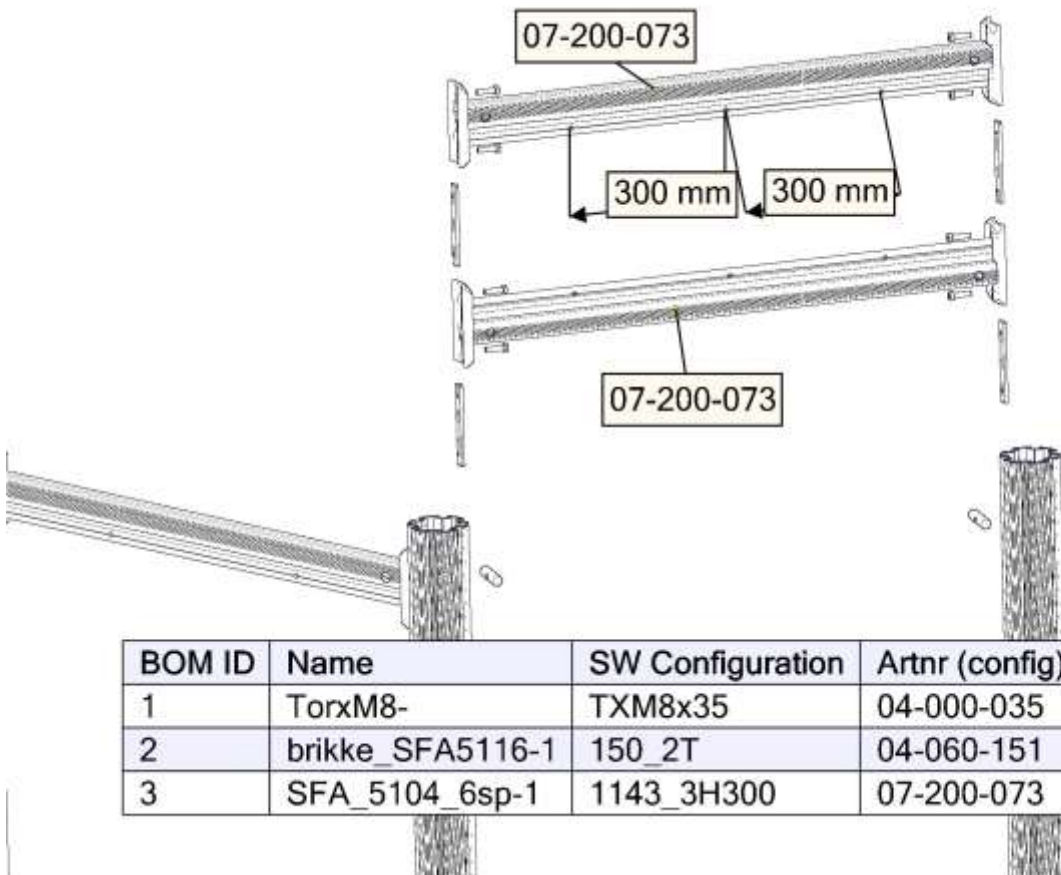
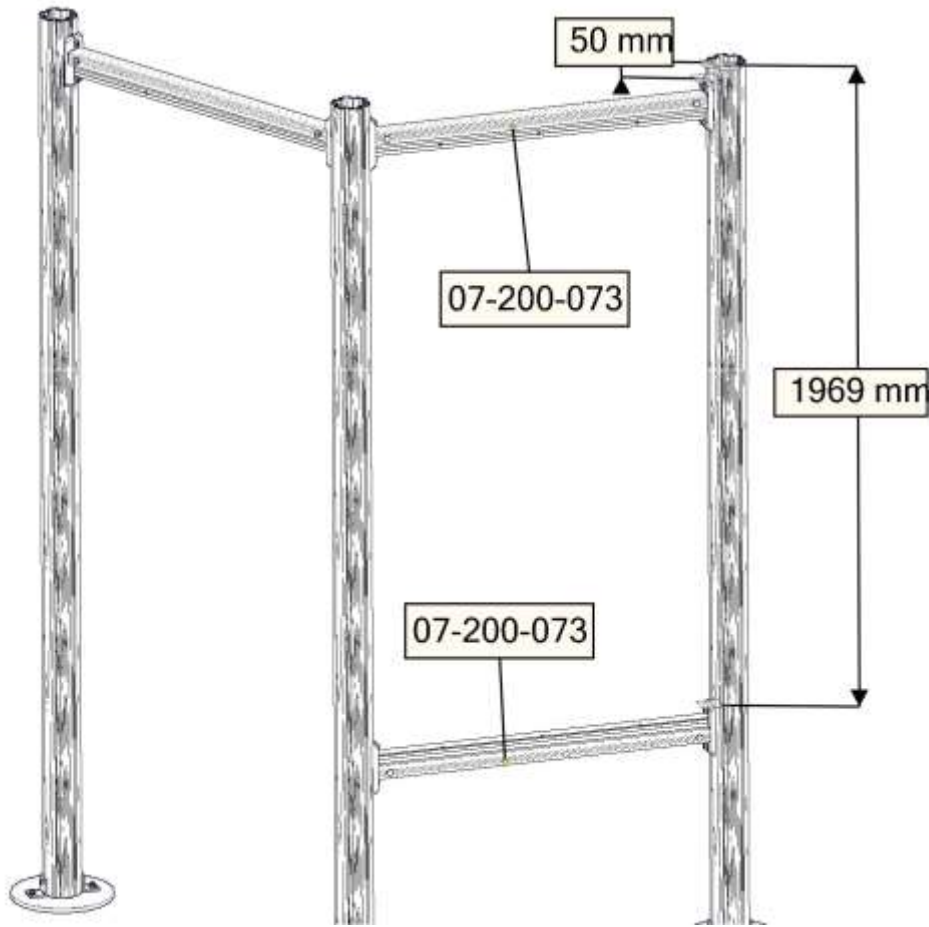

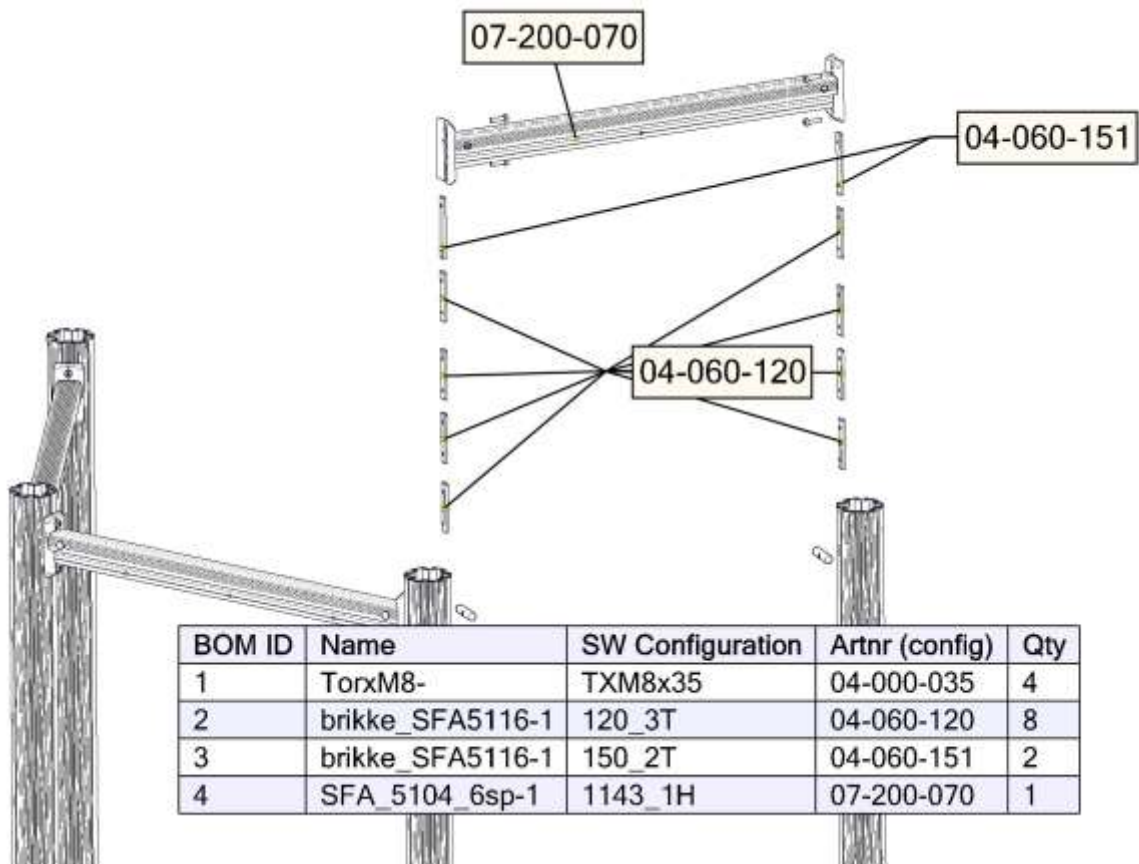
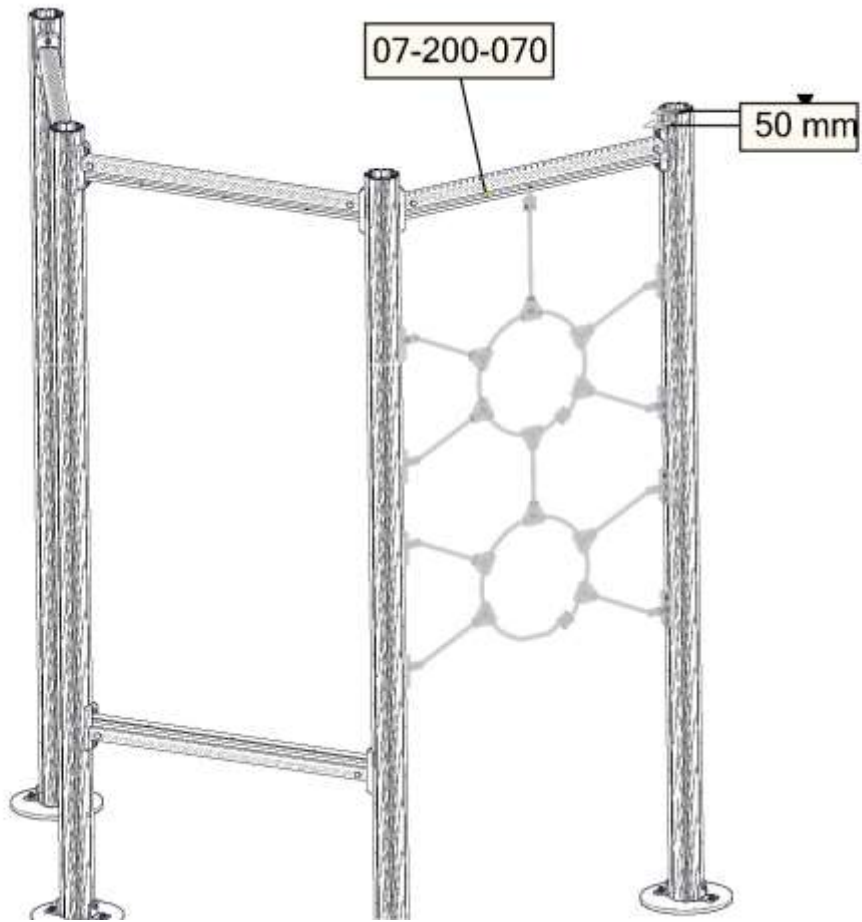

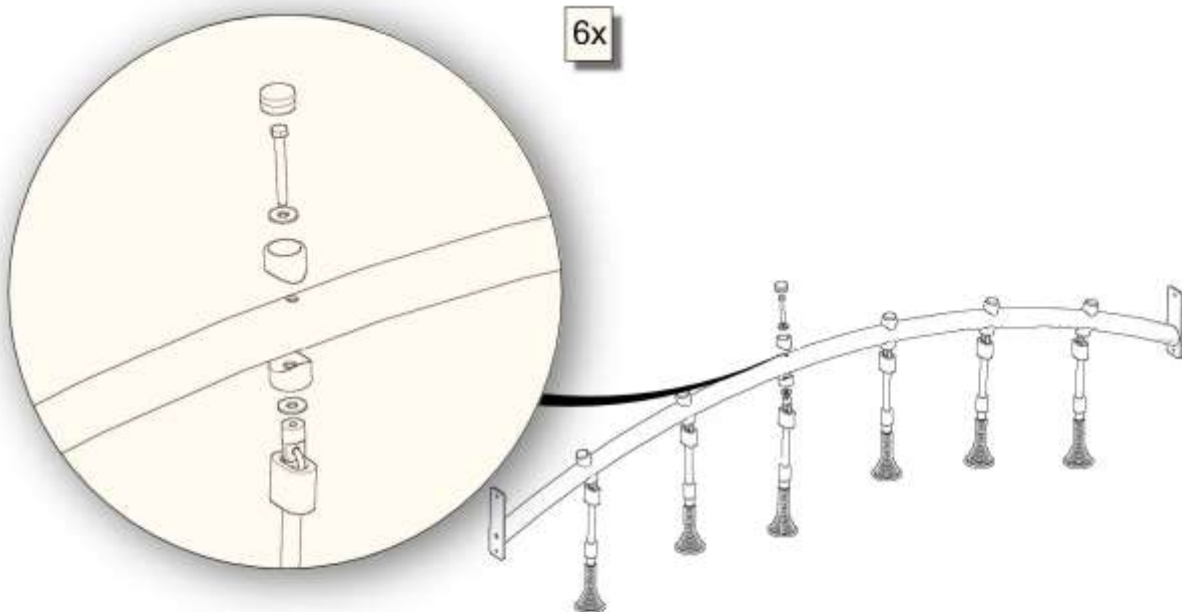
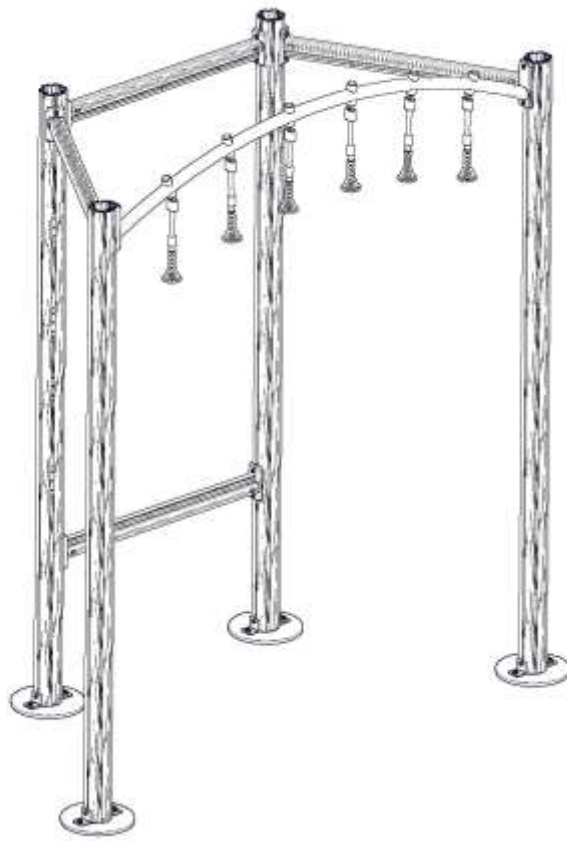

BOM ID	Name	SW Configuration	Artnr (config)	Qty
1	handtakk-1	Default	05-300-042	1
2	M8_sekskant-1	M08x70	04-008-070	1
3	plast_rordel-	Default	05-300-036	2
4	plast_rordel_end-1	Default	05-300-036	1
5	SkiveCovered-	M10_stor	04-055-036	2

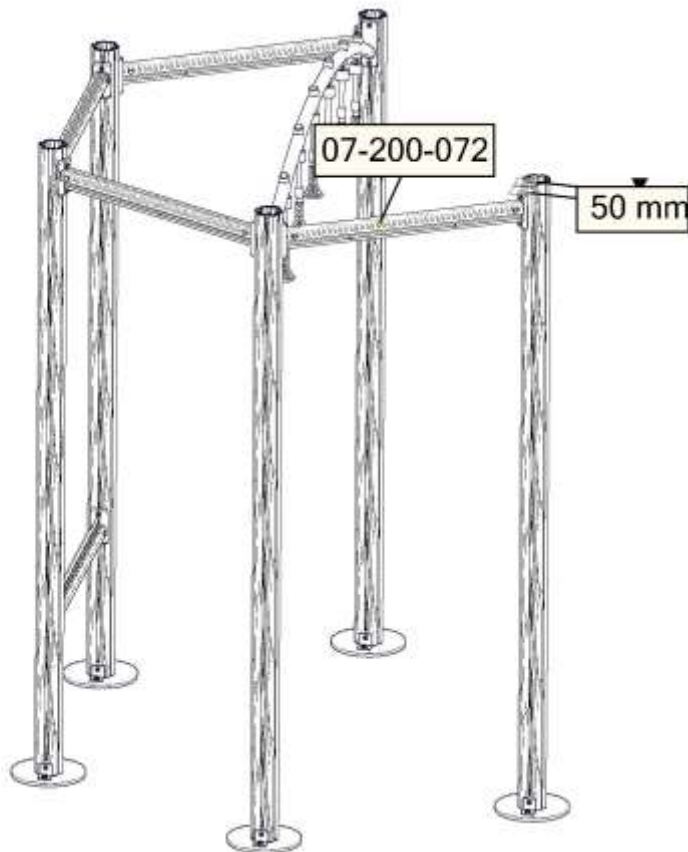
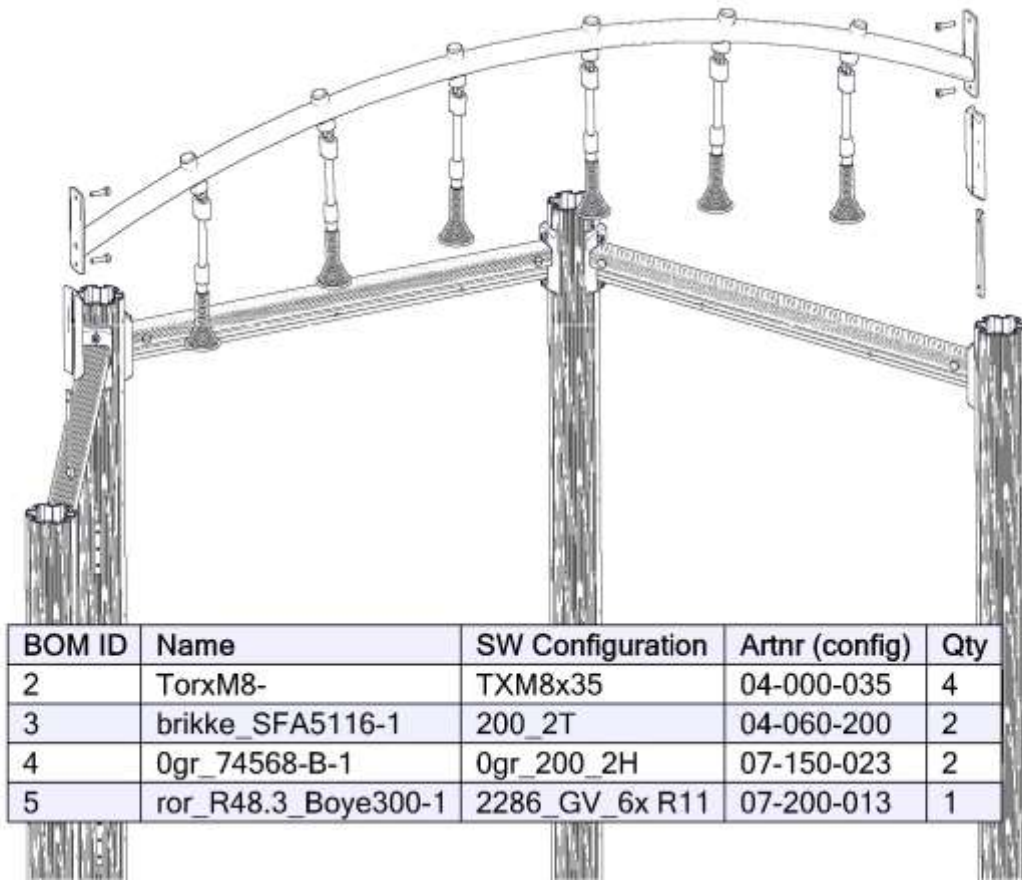

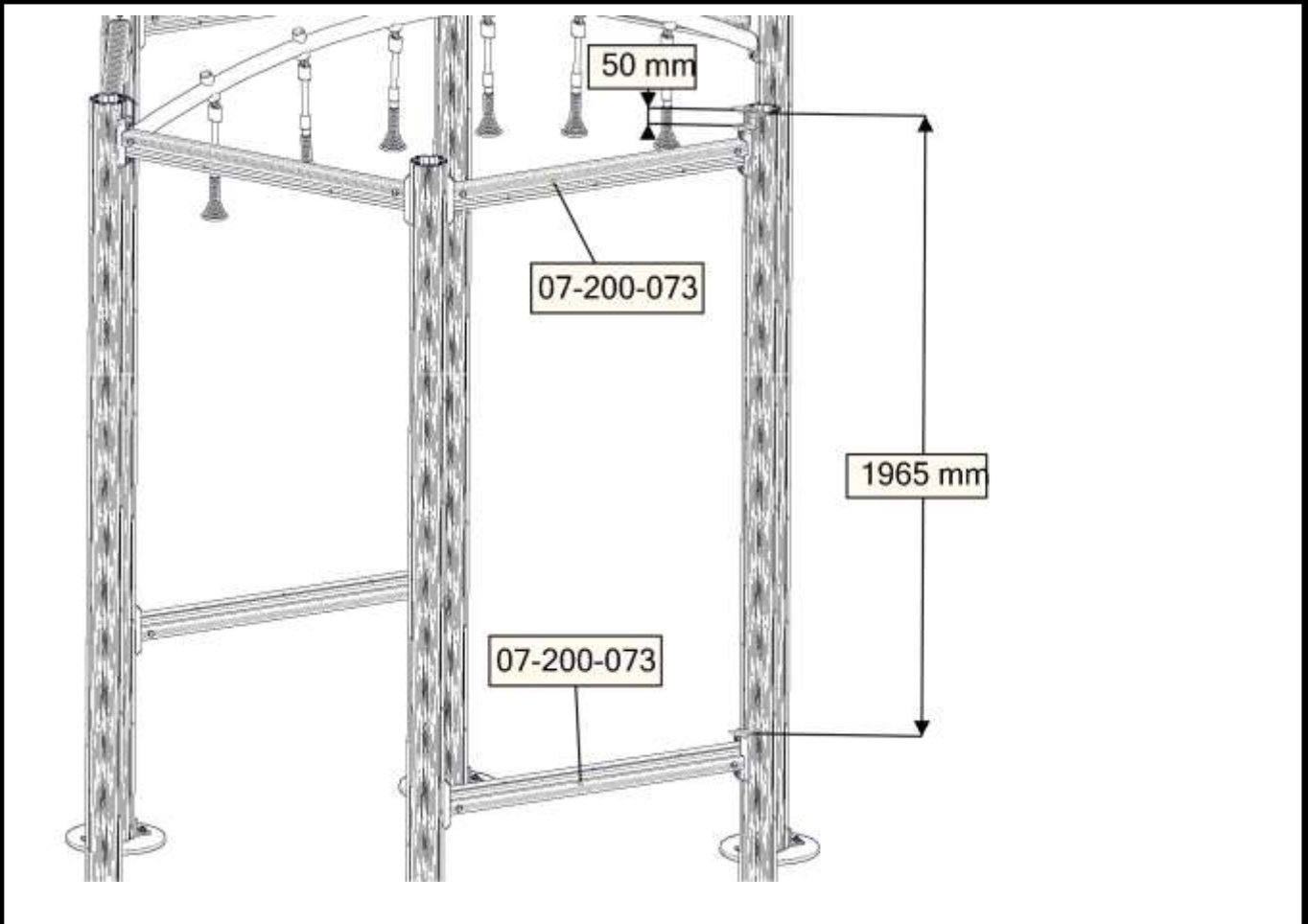
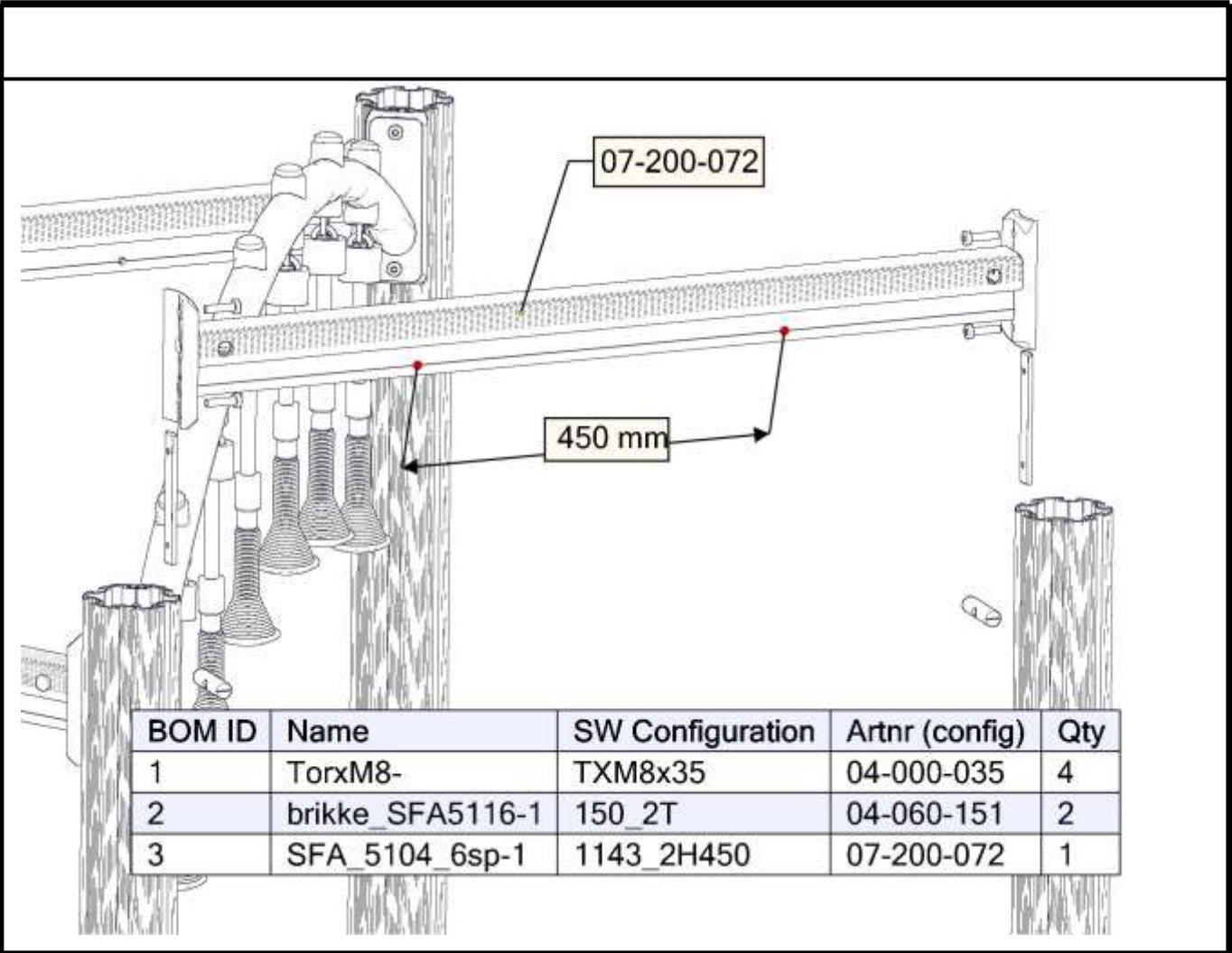

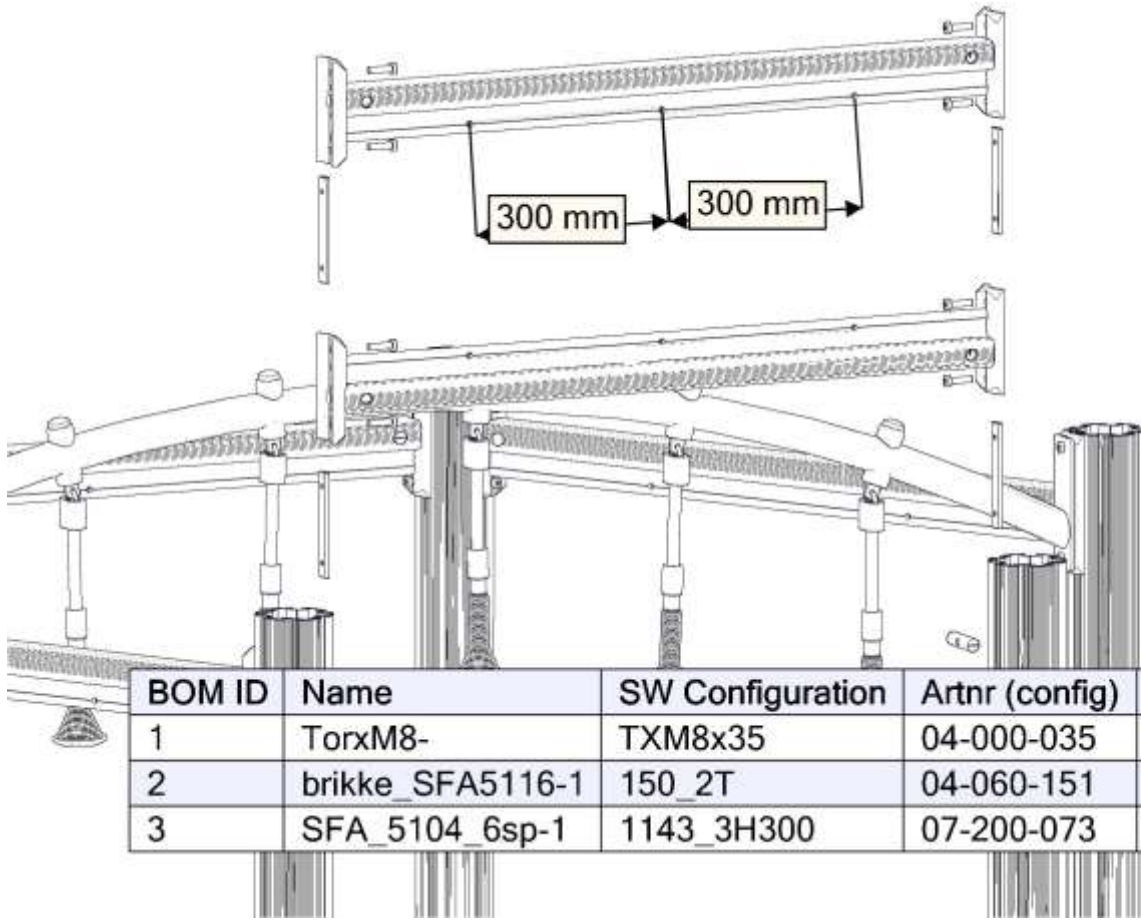

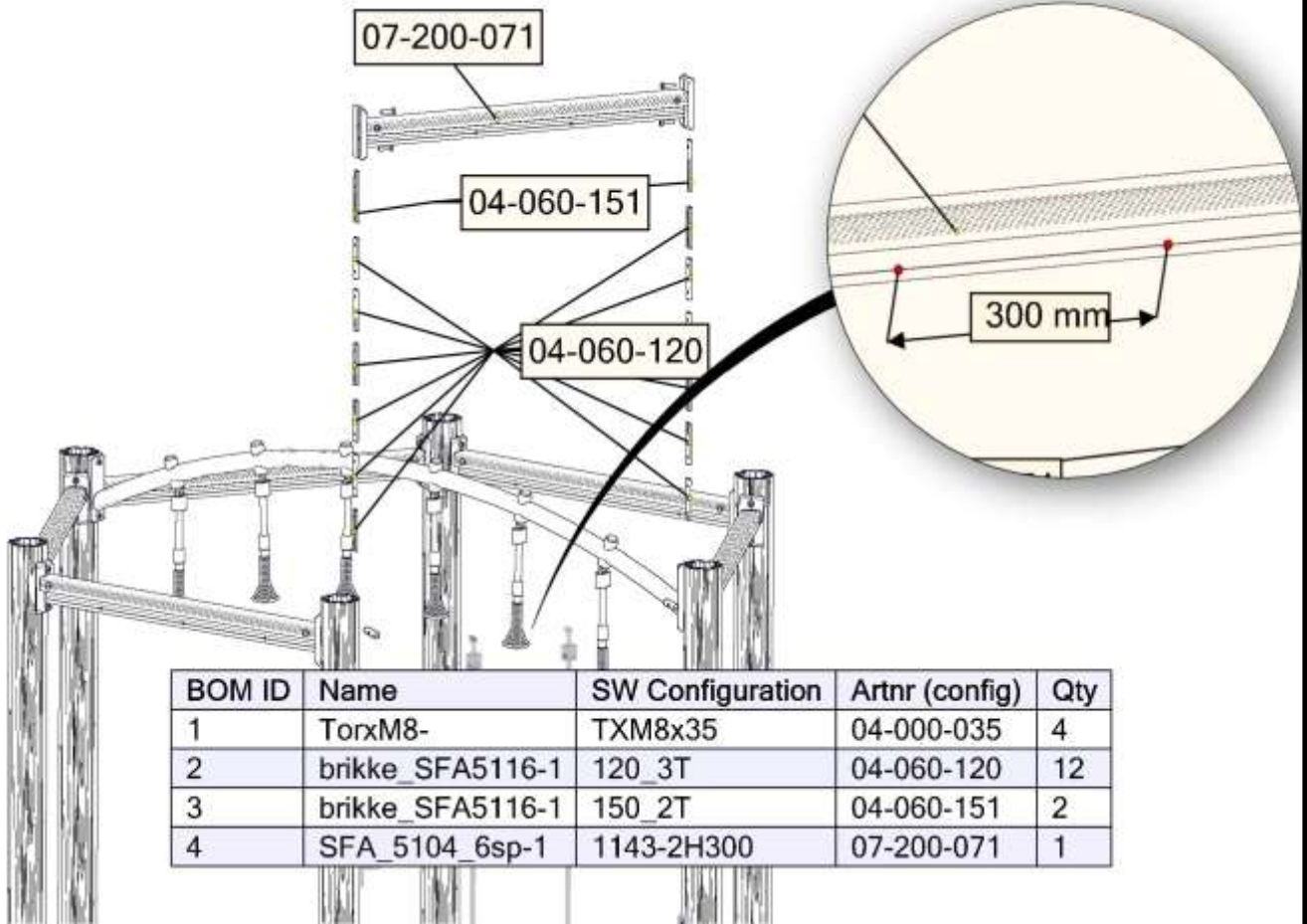

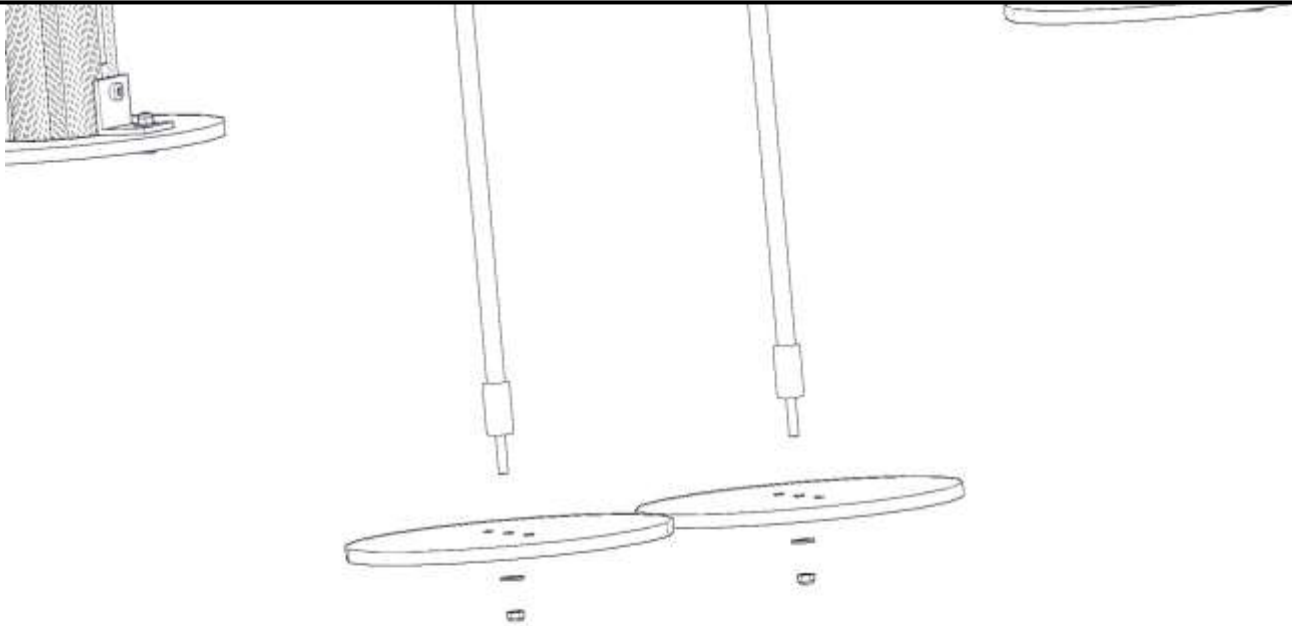

BOM ID	Name	SW Configuration	Artnr (config)	Qty
1	Fundament_platte_2H-	Hoh80	00-003-106	2
2	mutter_M8-	M8_Borg	04-040-008	2
3	Skive-	M8_stor	04-055-008	2
4	klatrene6kant-1	Default<As Machined>	05-300-080	1

12x

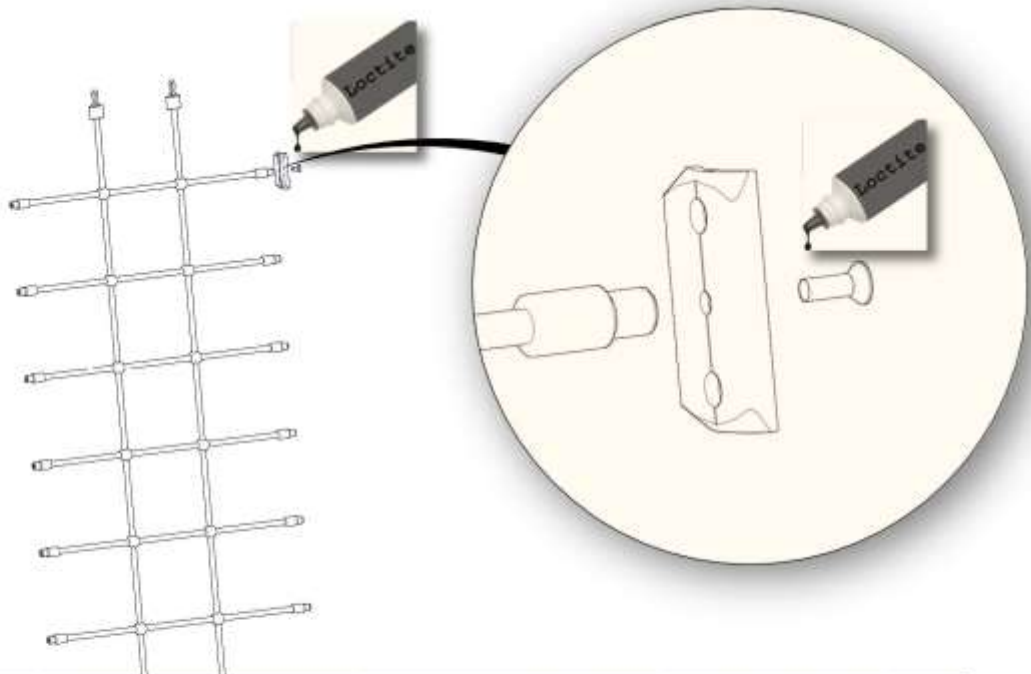

BOM ID	Name	SW Configuration	Artnr (config)	Qty
1	M10_V_Umbrako-1	M10x20	04-037-020	1
2	Ogr_74568-B-1	Ogr_120_2H_1V10	07-150-024	1

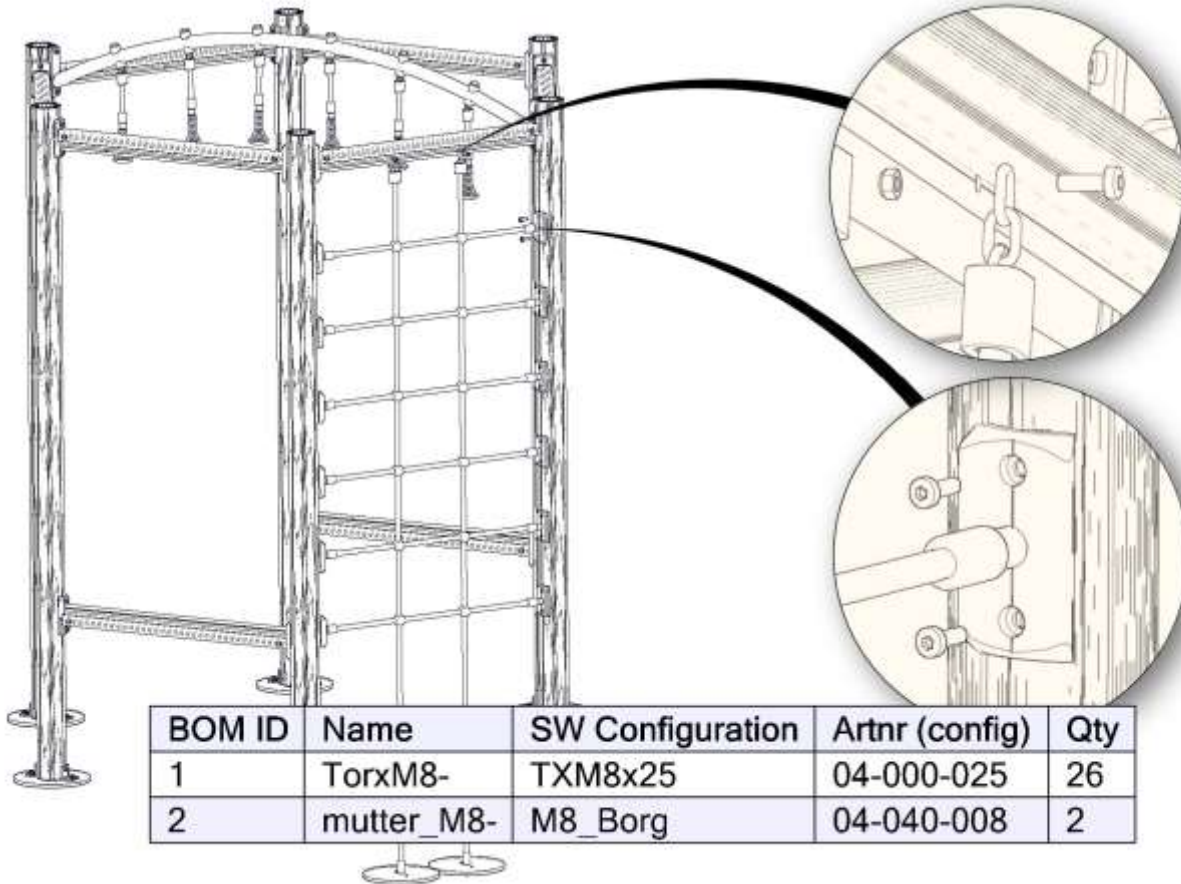

BOM ID	Name	SW Configuration	Artnr (config)	Qty
1	Torxm8-	TXM8x25	04-000-025	26
2	mutter_M8-	M8_Borg	04-040-008	2

07-500-083

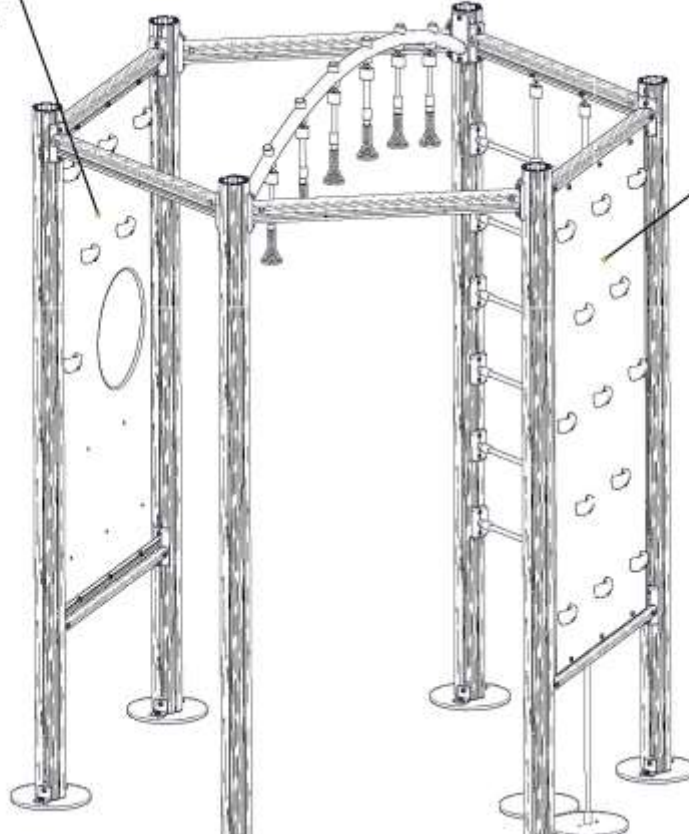

07-500-084

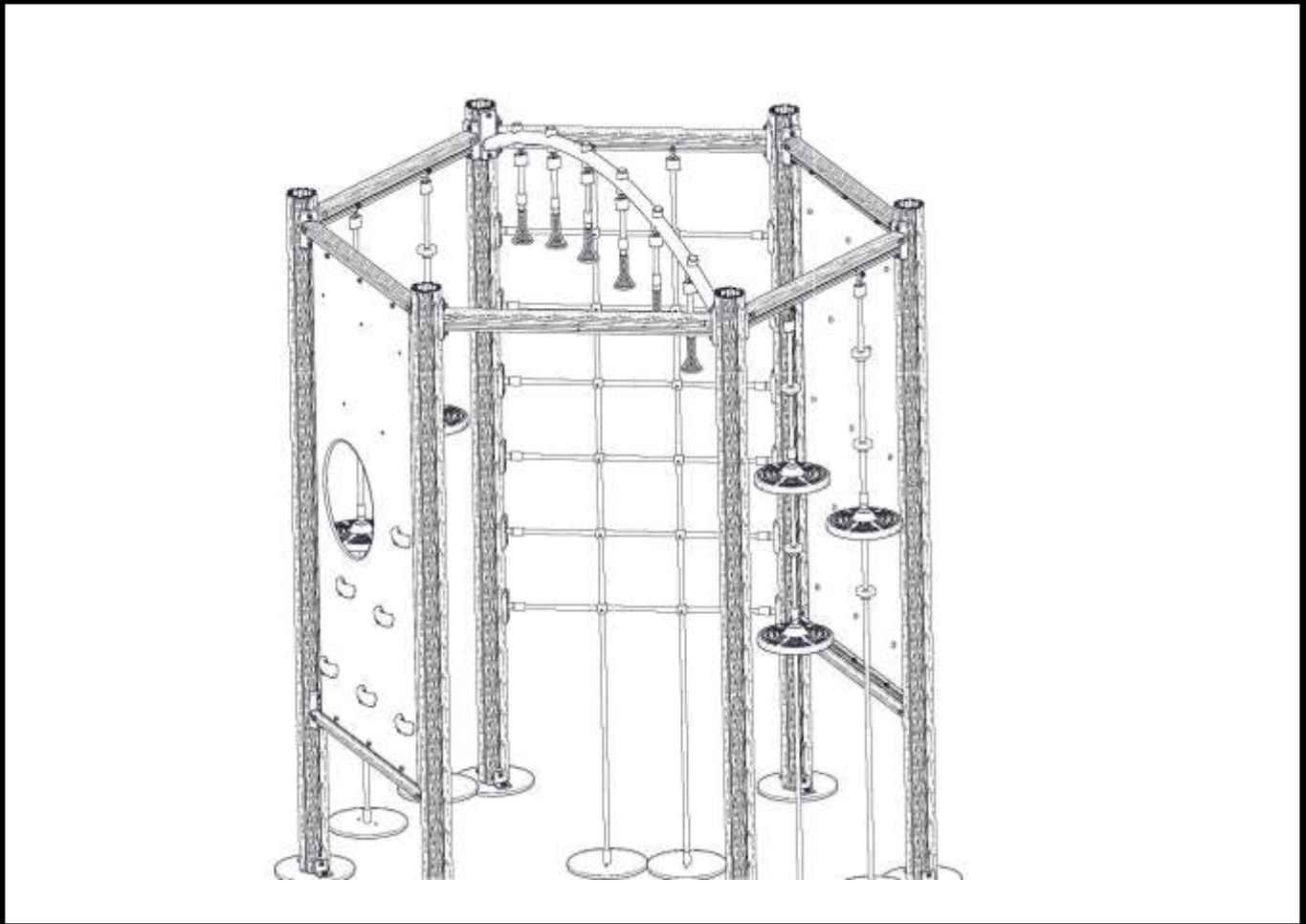
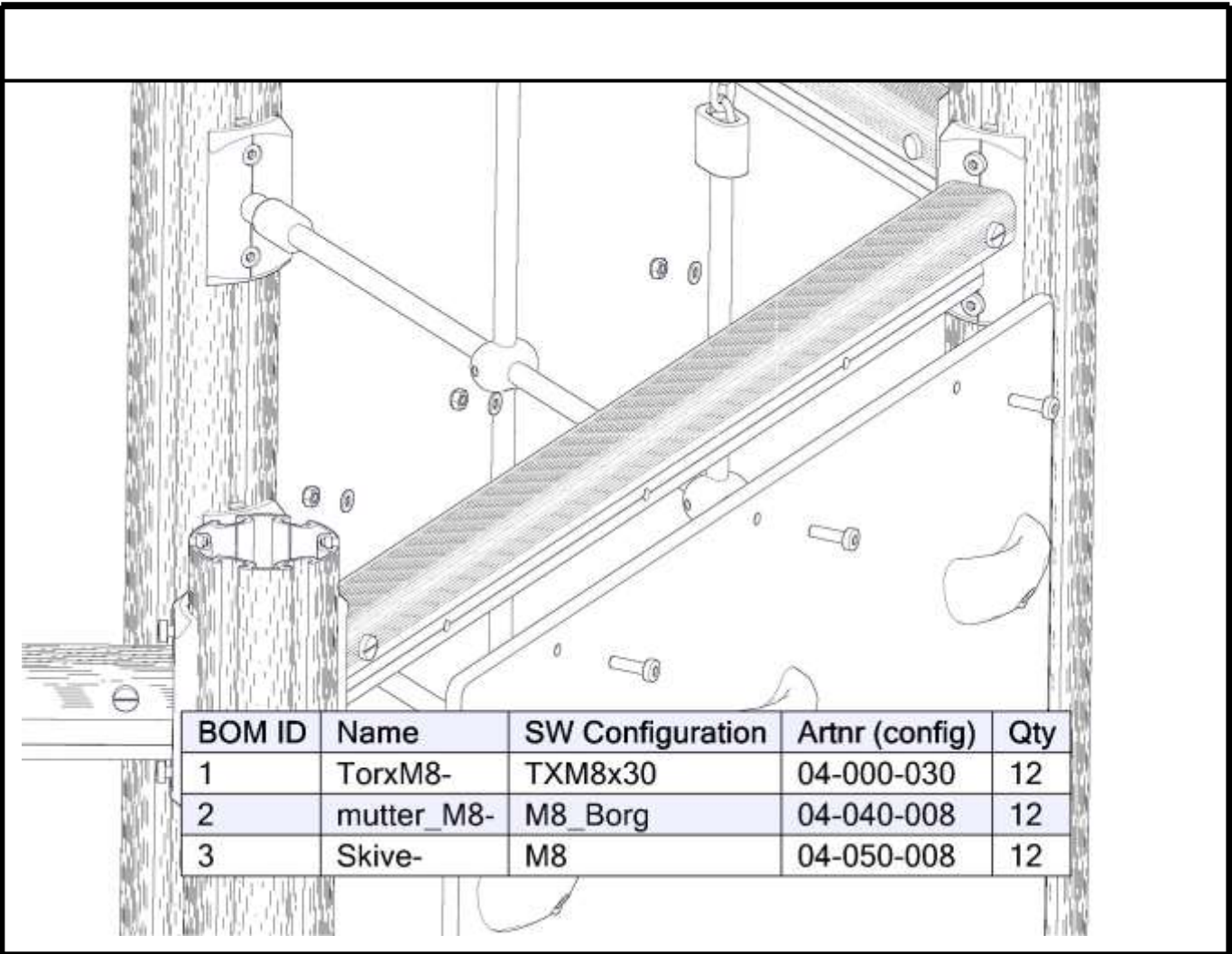

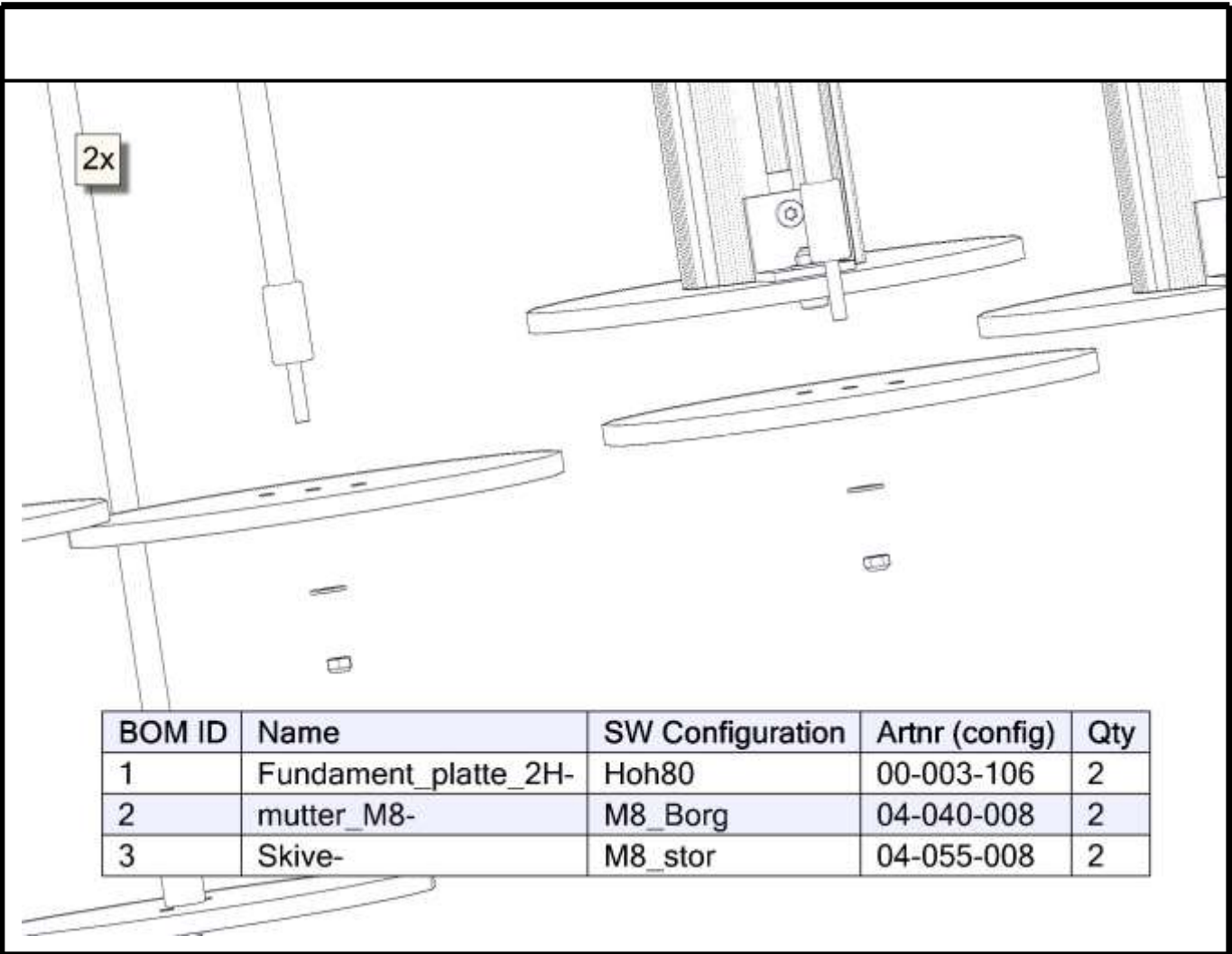

BOM ID	Name	SW Configuration	Artnr (config)	Qty
1	Fundament_platte_2H-	Hoh80	00-003-106	2
2	mutter_M8-	M8_Borg	04-040-008	2
3	Skive-	M8_stor	04-055-008	2

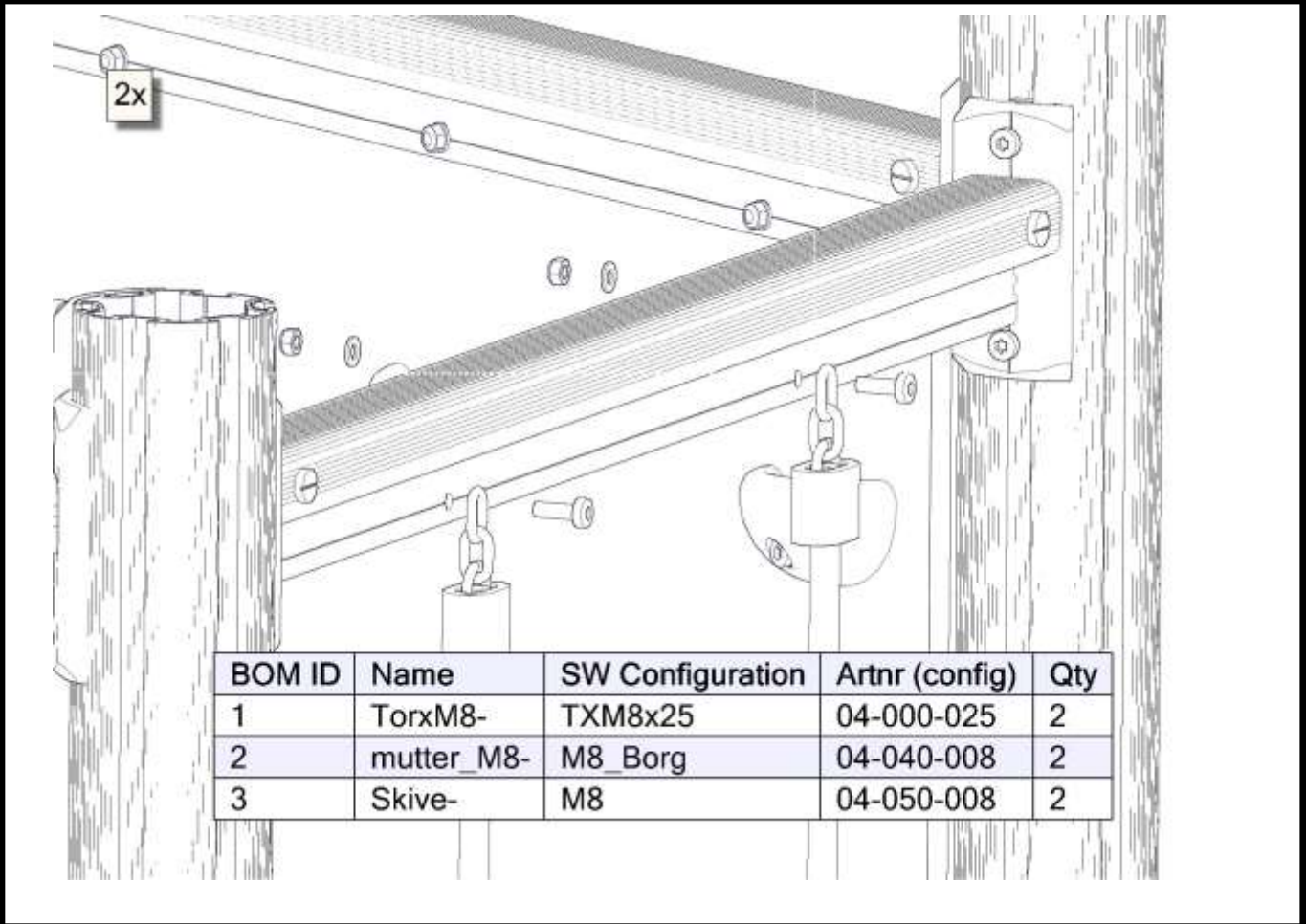

BOM ID	Name	SW Configuration	Artnr (config)	Qty
1	TorxM8-	TXM8x25	04-000-025	2
2	mutter_M8-	M8_Borg	04-040-008	2
3	Skive-	M8	04-050-008	2

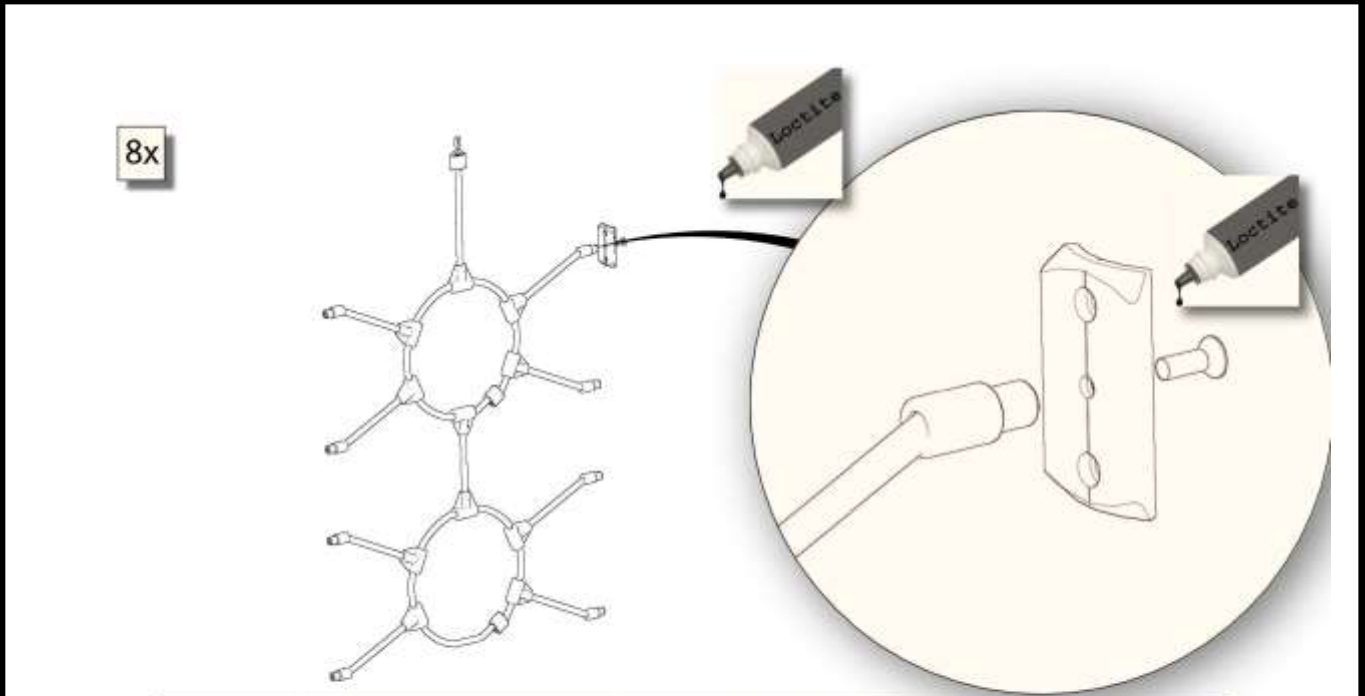
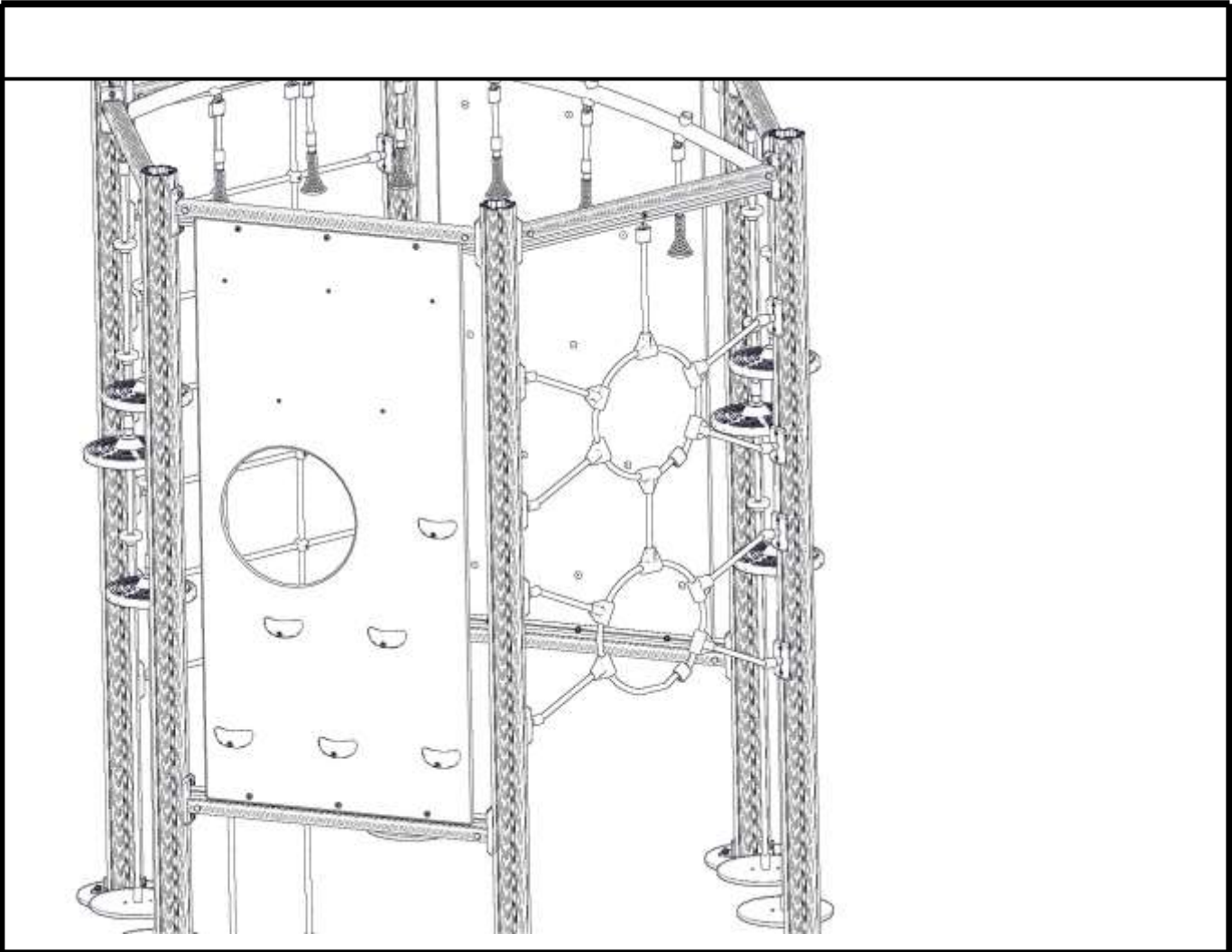

BOM ID	Name	SW Configuration	Artnr (config)	Qty
1	M10_V_Umbrako-1	M10x20	04-037-020	1
2	0gr_74568-B-1	0gr_120_2H_1V10	07-150-024	1

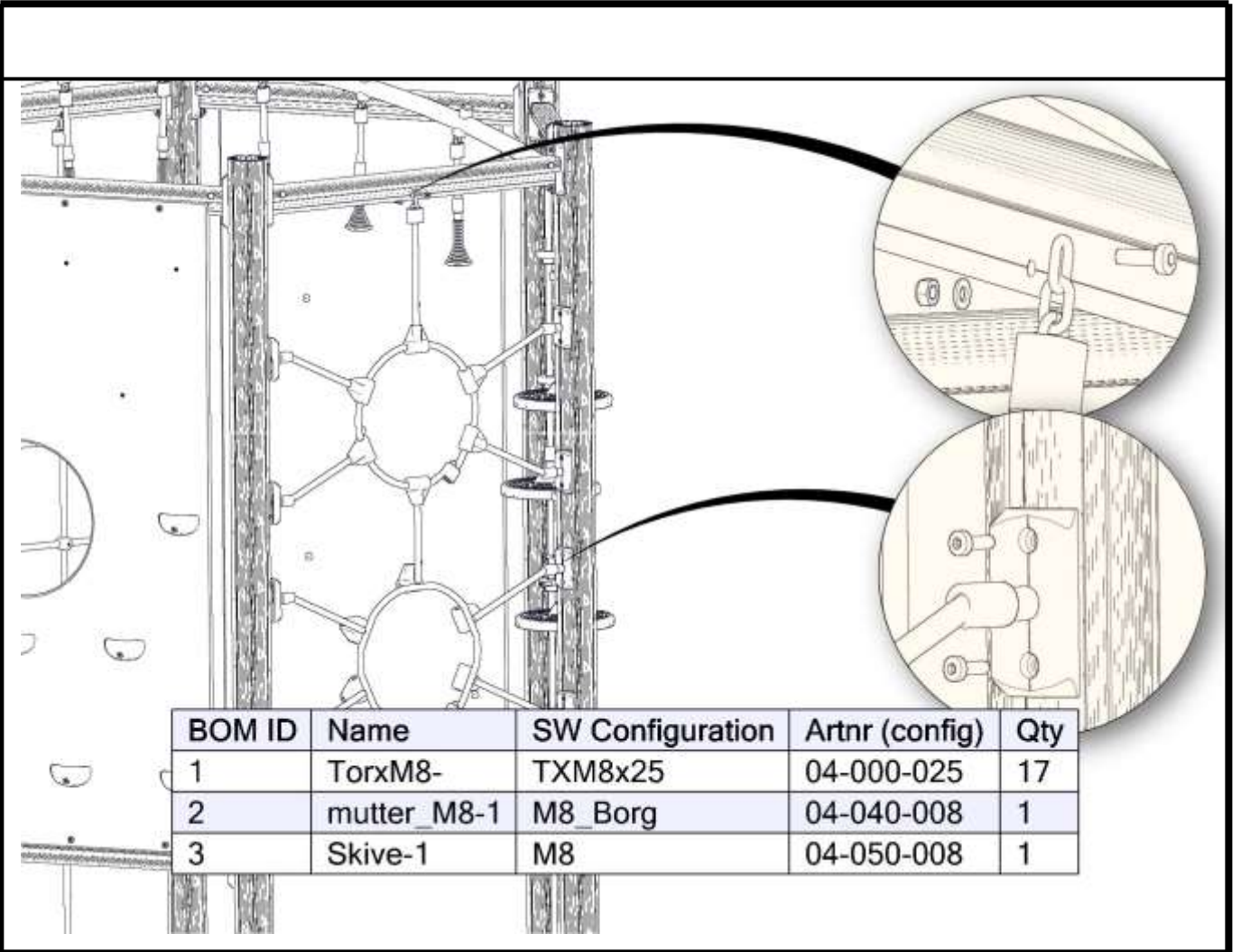

BOM ID	Name	SW Configuration	Artnr (config)	Qty
1	TorxM8-	TXM8x25	04-000-025	17
2	mutter_M8-1	M8_Borg	04-040-008	1
3	Skive-1	M8	04-050-008	1

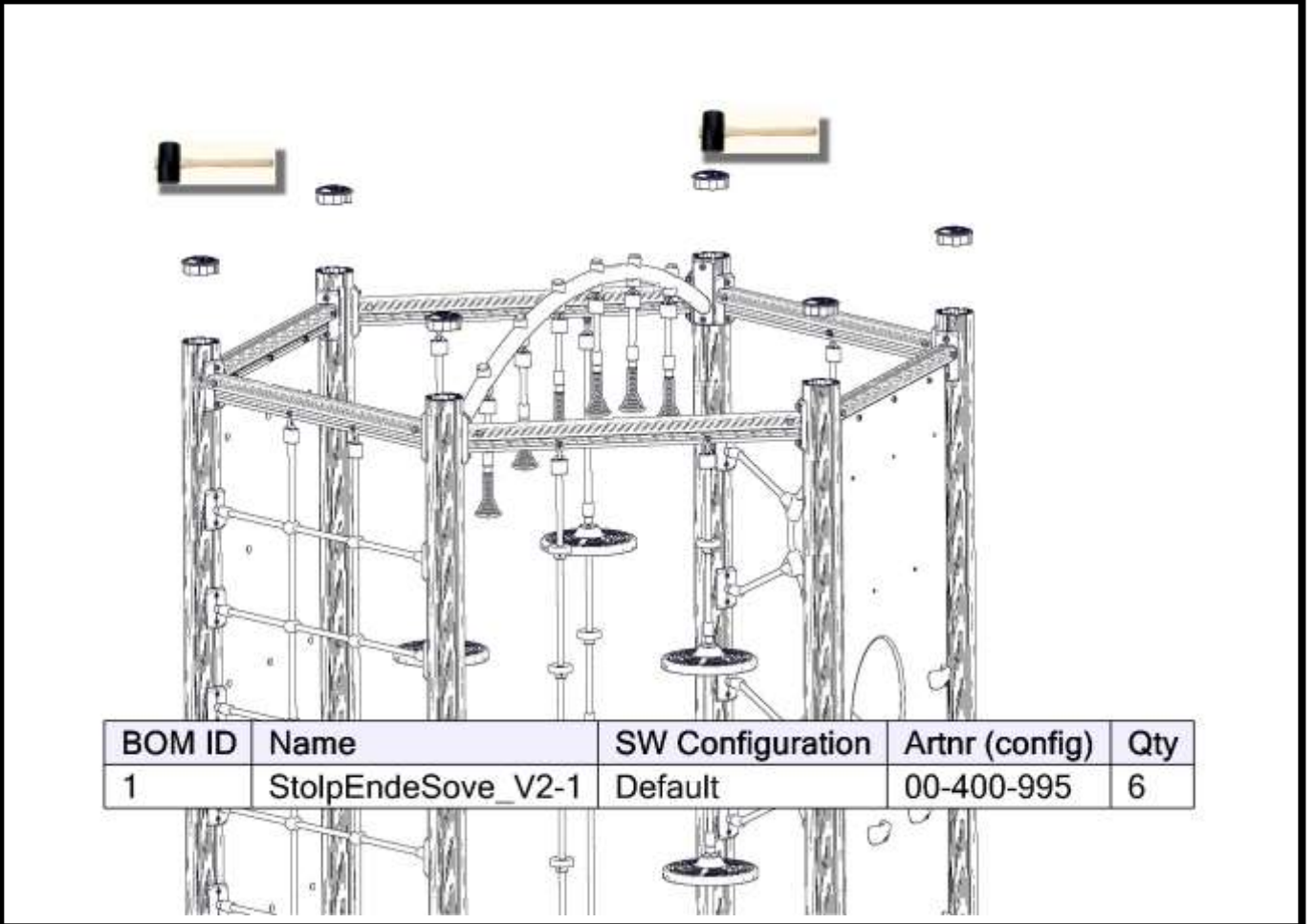

BOM ID	Name	SW Configuration	Artnr (config)	Qty
1	StolpEndeSove_V2-1	Default	00-400-995	6

Før utstyret tas i bruk / Before play begins / Innan lekredskapet tas i bruk	
N	<ul style="list-style-type: none"> • Påse at fallunderlag er utlagt i henhold til gjeldende regler eller vår anbefaling • Fjern alle monteringshjelpemidler (rester av betong, planker, paller, plast, og lignende) • Før utstyret tas i bruk, burde man sjekke at det ikke er fare for at anorakksnorer og lignende som kan hekte seg fast noen steder på lekeapparatet. (Vedlagte snor med dobbe (kneledd) kan brukes til å sjekke at dette er i orden. Se vedlagte veiledning for bruk av denne. Dette gjøres for å oppdage eventuelle feilmonteringer.?) • NB! Bør stå i 2-3 dager før bruk
UK	<ul style="list-style-type: none"> • Make sure the area and depth of safer surfacing are according to the current standard, or to the manufacturer's recommendation • Make sure all tools and surplus materials are removed before play begins • PS! When complete, allow 2-3 days for the concrete to set before use
S	<ul style="list-style-type: none"> • Kontrollera att fallunderlag är utlagt enligt gällande regler eller vårt rekomenation • Ta bort alla monteringshjälpmedel (rester av betong, plankor, pallar, plast och liknande) • Innan lekredskapet används, kontrollera att anoracksnoddar eller kläder/delar av kläder eller liknande inte kan fastna i några delar på redskapet. (Den bipackade "knävringen" kan man med fördel användas för denna kontroll. • Detta görs för att upptäcka eventuella felmonteringar.)











Boltepakker for / Boltpackage for / Boltpaket för

Sign. _____.

Stolpe 110	Ant= 4	Navn	Artnr/dimensjon	Ant	Lev
		Stolpe 110 L=2700 600-2100 (6)	07-100-327	6	
Stolpende	Ant= 4	Navn	Artnr/dimensjon	Ant	Lev
		End lokk (1)	00-400-995	6	
Fundament	Ant= 6	Navn	Artnr/dimensjon	Ant	Lev
		Funplate (1)	07-400-011	6	
		Vinkel 50x50x4 11mm (2)	04-070-050	12	
		Brikke 50 (2)	04-060-050	12	
		Torx M8x25 (2) Torx M8x30 (2)	04-000-025 04-000-030	12 12	
		Skive M8 (4)	04-055-008	24	
		Mutter M8 (2)	04-040-008	12	
Produktmerke	Ant= 1	Navn	Artnr/dimensjon	Ant	Lev
		Ogr 150_2H (2) Med Produktmerke	????	1	
		Brikke 150_2T(2)	04-060-150	1	
		Torx M8x35 (2)	04-000-035	2	

Boltepakker for / Boltpackage for / Bultpaket för

Sign. _____

Armgang	Ant= 1	Navn	Artnr/dimensjon	Ant	Lev
		Rør boye300 (1)	07-200-013	1	
		0gr_200_2H (2)	07-150-023	2	
		Brikke 200(2)	04-060-200	2	
		Torx M8x35 (4)	04-000-035	4	
		Handtak (6)	07-500-022	6	
		Sekskant M8x70 (6)	07-008-070	6	
		SkiveCovered (12)	04-055-036	12	
		Rørdel (12)	04-055-036	12	
		Rørdel-end(6)	04-055-036	6	

















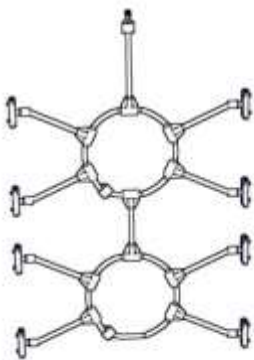

Boltepakker for / Boltpackage for / Bultpaket för

Sign. _____

Drager med 0gr beslag 1 hull	Ant= 1	Navn	Artnr/dimensjon	Ant	Lev
		Drager inkl 0gr beslag (1) Med 1 hull	07-500-370	1	
		Brikke 150_2T (2)	04-060-151	2	
		Torx M8x35 (4)	04-000-035	4	
Drager med 0gr beslag 2H 300	Ant= 1	Navn	Artnr/dimensjon	Ant	Lev
		Drager inkl 0gr beslag (1) Med 2 hull	07-500-371	1	
		Brikke 150_2T (2)	04-060-151	2	
		Torx M8x35 (4)	04-000-035	4	
Drager med 0gr beslag 2H 450	Ant= 2	Navn	Artnr/dimensjon	Ant	Lev
		Drager inkl 0gr beslag (1) Med 2 hull	07-500-372	2	
		Brikke 150_2T (2)	04-060-151	4	
		Torx M8x35 (4)	04-000-035	8	
Drager med 0gr beslag 3 Hull hoh300	Ant= 4	Navn	Artnr/dimensjon	Ant	Lev
		Drager inkl 0gr beslag (1) Med 3 hull	07-500-373	4	
		Brikke 150_2T (2)	04-060-151	8	
		Torx M8x35 (4)	04-000-035	16	











Boltepakker for / Boltpackage for / Bultpaket för

Sign. _____.

Klatrenett	Ant= 1	Navn	Artnr/dimensjon	Ant	Lev
		Klatrenett	07-500-080	1	
		Brikke 120_2T (12)	04-060-151	12	
		Torx M8x25 (26)	04-000-025	26	
		Ogr 120 2H_1V10 (12)	07-150-024	12	
		Umbrako M10x20 (12)	04-037-020	12	
		Loctite		1	
		Skive M8 (2)	04-055-008	2	
		Mutter M8 (4)	04-040-008	4	
		Fundamentplate (2)	00-003-106	2	
Klatre-spidernett	Ant= 1	Navn	Artnr/dimensjon	Ant	Lev
		Klatrenett (1)	07-500-081	1	
		Brikke 120_2T (8)	04-060-151	8	
		Torx M8x25 (17)	04-000-025	17	
		Ogr 120 2H_1V10 (8)	07-150-024	8	
		Umbrako M10x20 (8)	04-037-020	8	
		Loctite		1	
		Mutter M8 (1)	04-040-008	1	
		Skive m8 (1)	04-050-008		

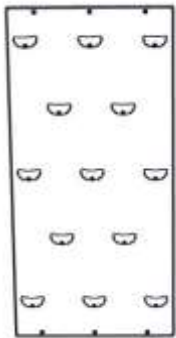
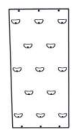
Boltepakker for / Boltpackage for / Bultpaket för

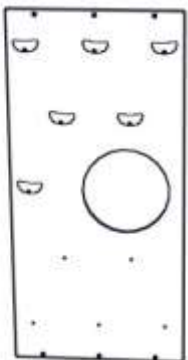
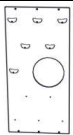
Sign. _____

Monkey Sett	Ant= 2	Navn	Artnr/dimensjon	Ant	Lev
		monkeysett (2)	07-500-082	2	
		Torx M8x25 (2)	04-000-025	4	
		Fundamentplate (2)	00-003-106	4	
		Skive M8 (4)	04-055-008	8	
		Mutter M8 (4)	04-040-008	8	
Klatrevegg	Ant= 1	Navn	Artnr/dimensjon	Ant	Lev
		Klatreplate (1)	07-500-084	1	
		Torx M8x30 (6)	04-000-030	6	
		Mutter M8 (6)	04-040-008	6	
Klatrevegg med hull	Ant= 1	Navn	Artnr/dimensjon	Ant	Lev
		Klatreplate (1)	07-500-083	1	
		Torx M8x30 (6)	04-000-030	6	
		Mutter M8 (6)	04-040-008	6	