

**N****Monteringsanvisning****EN****Assembly Instructions****S****Monteringsanvisning**

Produkt nr. / Product no. / Produkt nr.

**14-200-040**

Ord. nr. \_\_\_\_\_

Dato. \_\_\_\_\_

Sign. \_\_\_\_\_

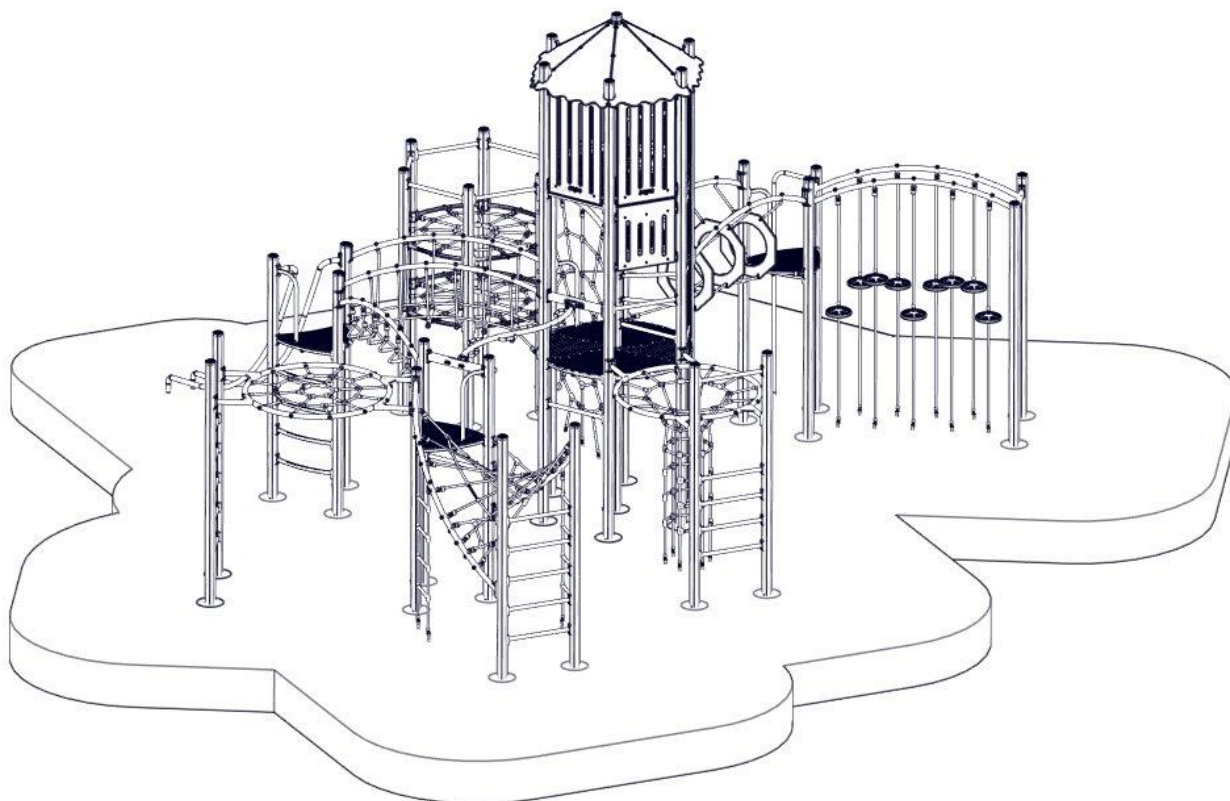
**søve**

Søve AS  
Grønnvoldveien 290  
3830 Ulefoss - Norway  
Tlf: +47 35 94 65 65  
[www.sove.no](http://www.sove.no)

**søve**

Søve AB  
EA Rosengrensgatan 32  
421 31 Västra Frölunda  
Phone: +46 (0)31 773 97 00  
[www.sove.se](http://www.sove.se)

**Monteringstips / Assembly Advice / Monteringsstips****N**

- Les monteringsanvisningen nøye før montering.
- Monter elementene i rekkefølgen som vist.
- Boltene bør ikke skrues for hardt til før alt er montert, vatret og loddet. Skru så boltene til.
- NB! Ved bruk av drill, kan boltene ryke.
- På grunn av at solen kan gjøre rutsjeflaten veldig varm, bør rutsjebanens utløp vende mot nord-øst eller nord-vest.
- Er lekeutstyret plassert i naturlige ferdselstraséer må området sikres mot gjennomgang.
- Innspringningshinder bør vurderes rundt lekeapparater hvor det er stor bevegelse, f.eks. ved huskestativ.
- Det bør være fritt innsyn til lekeutstyr som er beregnet for barn under 3 år.

**NB! Under monteringsarbeidet må utstyr, som ikke er forankret forsvarlig i bakken, sikres slik at det ikke velte.**

**Området må avstenges under montering av apparatene med sperrebånd eller lignende.**

**EN**

- Read the instruction carefully before assembling the play unit.
- Assemble the components in the sequence shown in these instructions. Fixings must not be fully tightened during assembly. Before casting the foundations, the structure must be level and plumb, at which point all fixings are tightened. PS! If use of drill, the bolts may be wrecked.
- Avoid positioning the slide facing due south because of overheating – ideal positions are facing north-east or north-west. Secure the construction-area to prevent people from walking through it.
- Consider installing barriers around play-equipment which gives rise to a lot of activity – i.e. swings.
- Ensure that clear vision is possible across the play area so that supervision is possible from any position, particularly where children under 3 years of age will be playing.

**NB! During assembly of the equipment, ensure that all structures are securely propped, especially when left overnight. Also ensure that equipment is supported**

**Monteringstips / Assembly Advice / Monteringsstips****S**

- Läs monteringsanvisningen noga före montering.

- Montera delarna i den ordningen som anvisas
- Skruvarna bör inte skruvas för hårt tills allt är monterat, i våg och lodat.









OBS! Används elektrisk skruvdragare, kan bulten gå sönder. Hårdra därför manuellt!

- Solen kan göra att rutchbanan blir väldigt varm. Banans nedfart rekommenderas att vändas i norrlig riktning
- Om lekplatsen placeras vid en gångväg mm bör området säkras mot genomfart av gående och cyklister.
- Insprängningshinder bör placeras runt lekutrustning med stor rörelse, t ex, gungställning.
- Det bör vara fri insyn till lekutrustning beräknat till barn under 3 år.

**OBS! Under monteringsarbete bör utrustningen som inte ska förankras i marken, ställs så att den inte kan välta.**

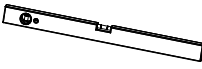
**Området måste spärras när lekutrustningen byggs upp, med avspärrningsband eller liknande.**

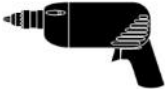
**Nødvendig verktøy / Tools required / Nödvändiga verktyg**





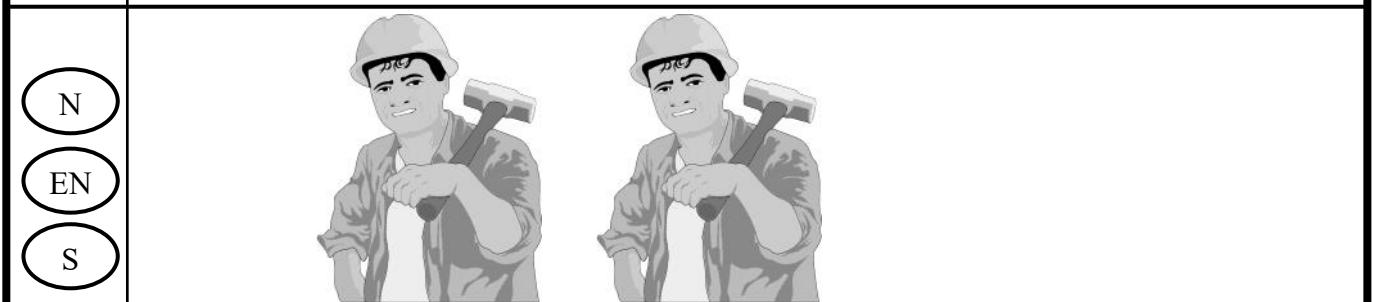

<p>(N)</p> <p>(EN)</p> <p>(S)</p>	<p>(A)</p> 	<p>(B)</p> <p>Torx Nr 45 High quality</p> 	<p>(C)</p> <p>13 + 17mm</p> 	<p>(D)</p> 	<p>(E)</p> 
		<p>Metermål Metric measure Tumstock</p> 	<p>16 V</p> 	<p>Merkebånd Mark ribbon Märkeband</p> 	<p>5 mm 6 mm</p> 

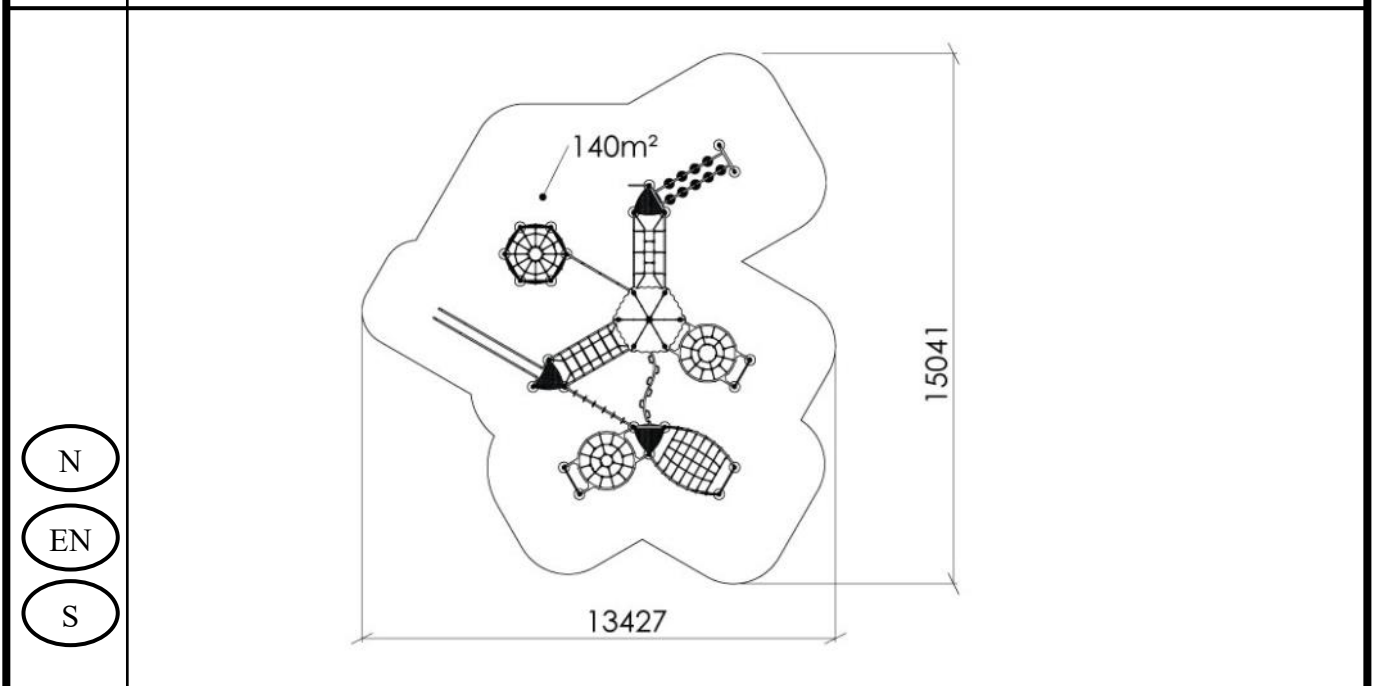
**Nødvendig antall personer / Number of persons required / Rekommenderad antal personer**

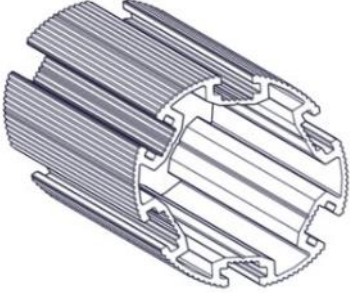

**Anbefalt arealbehov ved montering / Recommended working space / Rekommenderad arealbehov vid montering**









<b>Boltepakker for / Boltpackage for / Bultpaket för</b>		Sign. _____.		
<b>Thorium Monazitt 14-200-040</b>	<b>Navn</b>	<b>Artnr/dimensjon</b>	<b>Ant</b>	<b>Lev</b>
	Stolpe Ø110 L=3650 Grå	SFA5126/2	2	
	Stolpe Ø110 L=3450 Grå	SFA5126/2	21	
	Endelokk til stolpe Ø110	00-400-995	30	
	Thorium Tårn-del 1	14-200-Tårn1 (se egen del- montering)	1	
	Thorium Tårn del 2	14-200-Tårn2 (se egen del- montering)	1	
	Sperrerør bøyd uten hull L=750 Grønn	07-500-072K (se egen del- montering)	4	
	Sperrerør rett uten hull L=750 Sort	07-500-075K (se egen del- montering)	19	
	Sperrerør rett L=750 Uten hull Grønn	07-500-059K (se egen del- montering)	23	

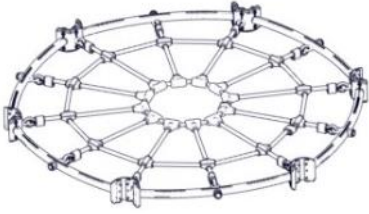





**Boltepakker for / Boltpackage for / Bultpaket för**

Sign. \_\_\_\_\_

Thorium Monazitt 14-200-040	Navn	Artnr/dimensjon	Ant	Lev
	Edderkoppnett horisontalt CC880 Grønn	07-500-210K (se egen del- montering)	2	
	Edderkoppnett 30gr L=2200 Grønn	07-500-032K (se egen del- montering)	1	
	Sluse H=790 Grønn	07-500-074K (se egen del- montering)	4	
	Bro tordert nett Med 2 x stige lang	07-500-305K (se egen del- montering)	1	
	Gulv 3-kant standard CC880 Grå	07-300-104K (se egen del- montering)	2	
	Gulv 3-kant 1konkav 880 x 880 Grå	07-300-105K (se egen del- montering)	1	

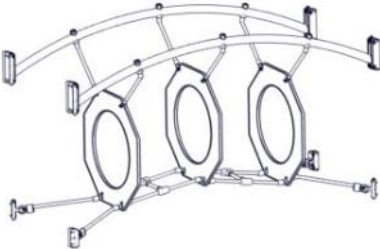

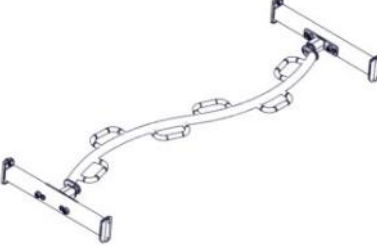
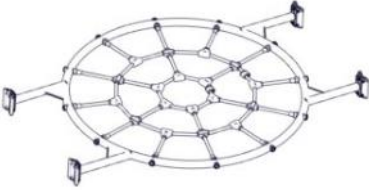

**Boltepakker for / Boltpackage for / Bultpaket för**

Sign. \_\_\_\_\_.

Thorium Monazitt 14-200-040	Navn	Artnr/dimensjon	Ant	Lev
	Bro HPL plate komplett Grønn	07-500-436K (se egen del- montering)	1	
	Dobbel monkeyseats bro Grønn	07-500-425K (se egen del- montering)	1	
	Brannstang Gulv = 1,95m Grå	07-200-037K (se egen del- montering)	1	
	Bro rundgang med sjakt CC880 L=2200 Grønn	07-200-260K (se egen del- montering)	1	
	Bevegelig armgang Grønn	07-500-281K (se egen del- montering)	1	
	Bro rundgang CC880 L=2200 Grønn	07-200-261K (se egen del- montering)	1	

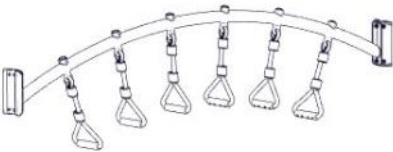
**Boltepakker for / Boltpackage for / Bultpaket för**

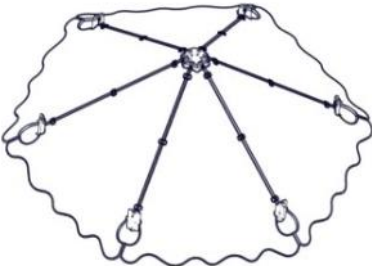
Sign. \_\_\_\_\_

Thorium Monazitt 14-200-040	Navn	Artnr/dimensjon	Ant	Lev
	Trapes bro CC880 Grønn	07-500-011K (se egen del- montering)	1	
	Armgang med polyfix trekant håndtak 30gr beslag Grønn	07-500-458K (se egen del- montering)	1	
	Slider rør	07-200-010K (se egen del- montering)	1	
	Tak 6-kant Grå	07-520-600K (se egen del- montering)	1	
	Produktmerke	07-500-500 (se egen del- montering)	1	

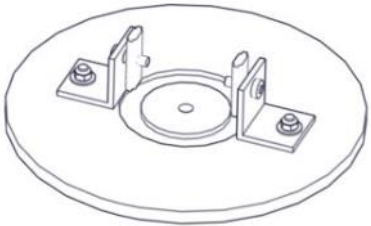

<b>Boltepakker for / Boltpackage for / Bultpaket för</b>		Sign. _____.		
<b>Thorium Monazitt 14-200-040</b>	<b>Navn</b>	<b>Artnr/ dimensjon</b>	<b>Ant</b>	<b>Lev</b>
	<b>Fundament Støp</b>			
	Støpefundament Dimensjon	00-003-111K (se egen del- montering)	23	
	<b>Fundament Nedgravning</b>			
	Fundamentplate Stolpe Komplett 1 x 110	07-400-101K (Se egen del- montering)	23	

**Fundamentering med betong / Foundation concrete / Förankring med betong**

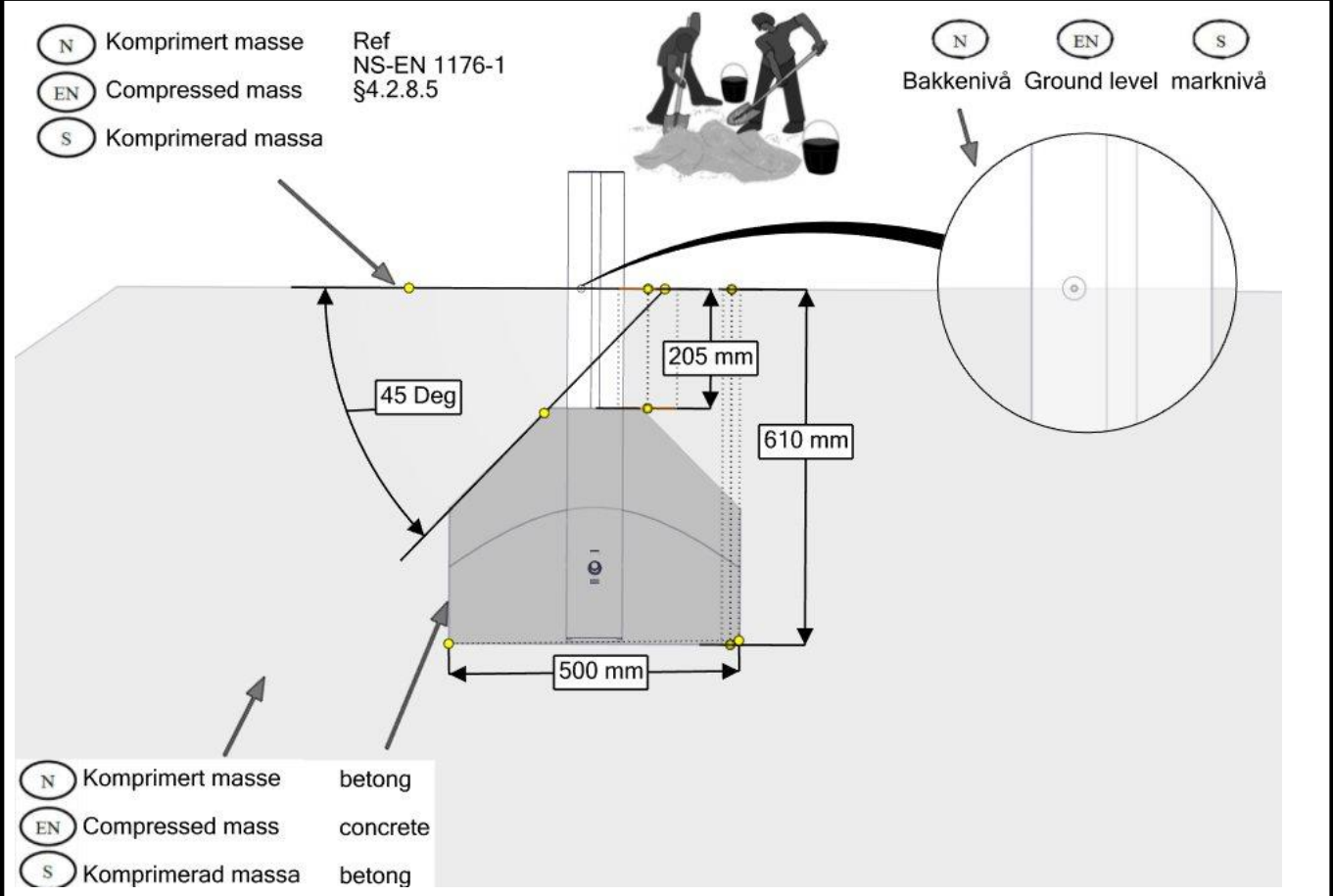

**Fundamentering uten betong / Foundation without concrete / Förankring utan betong**

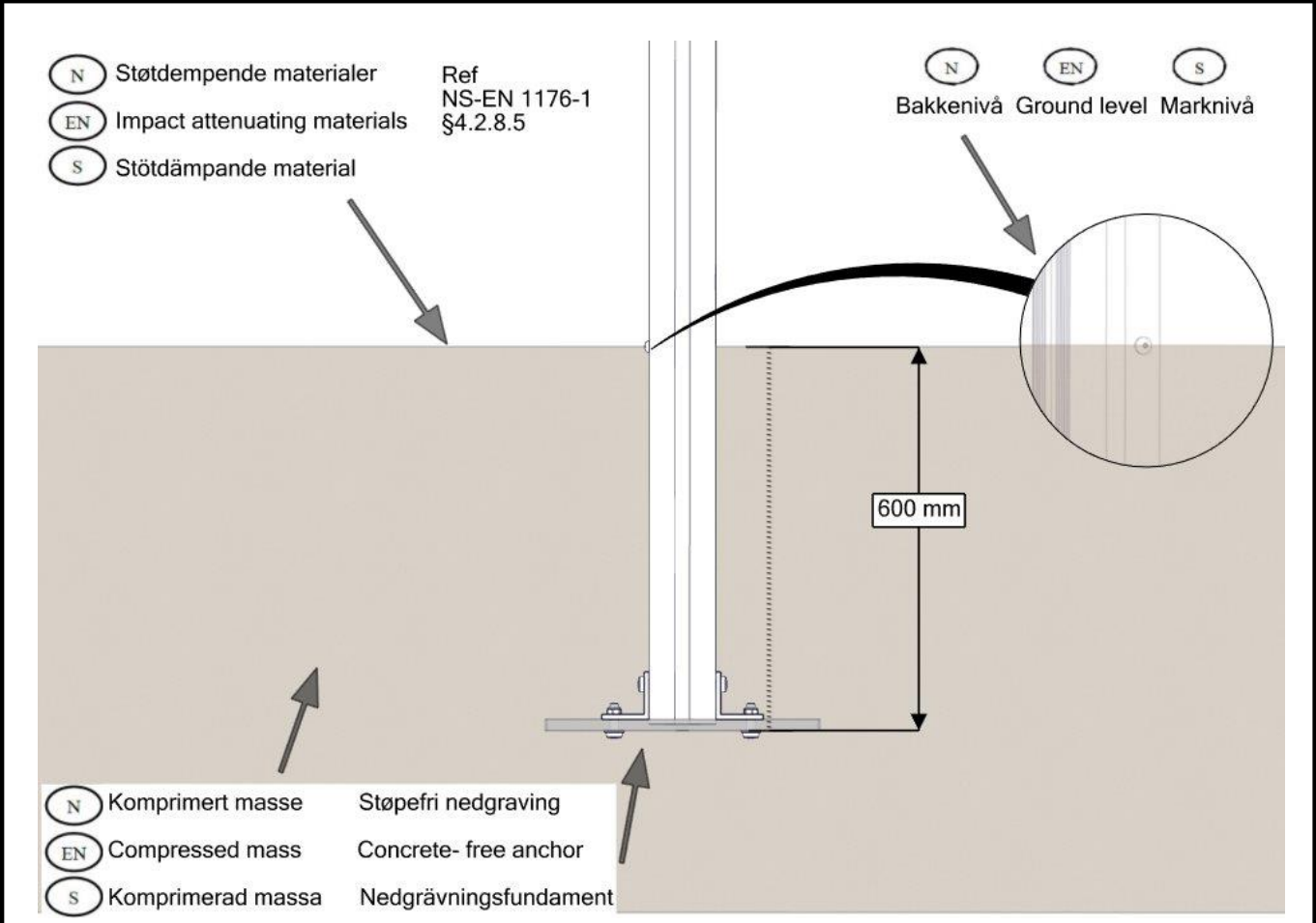

N

Alle mål er oppgitt i millimeter

EN

Scale measured in mm

S

Alla mått är i millimeter.

N

Bolten skrues HELT igjennom aluminiumen.  
Maks dreiemoment: 30Nm

EN

The bolt must be tightened in to the post, so that it peirces the aluminium  
Max torque: 30Nm

S

Bulten skruvas HELT ignom aluminiumen.  
Maks vridmoment: 30Nm

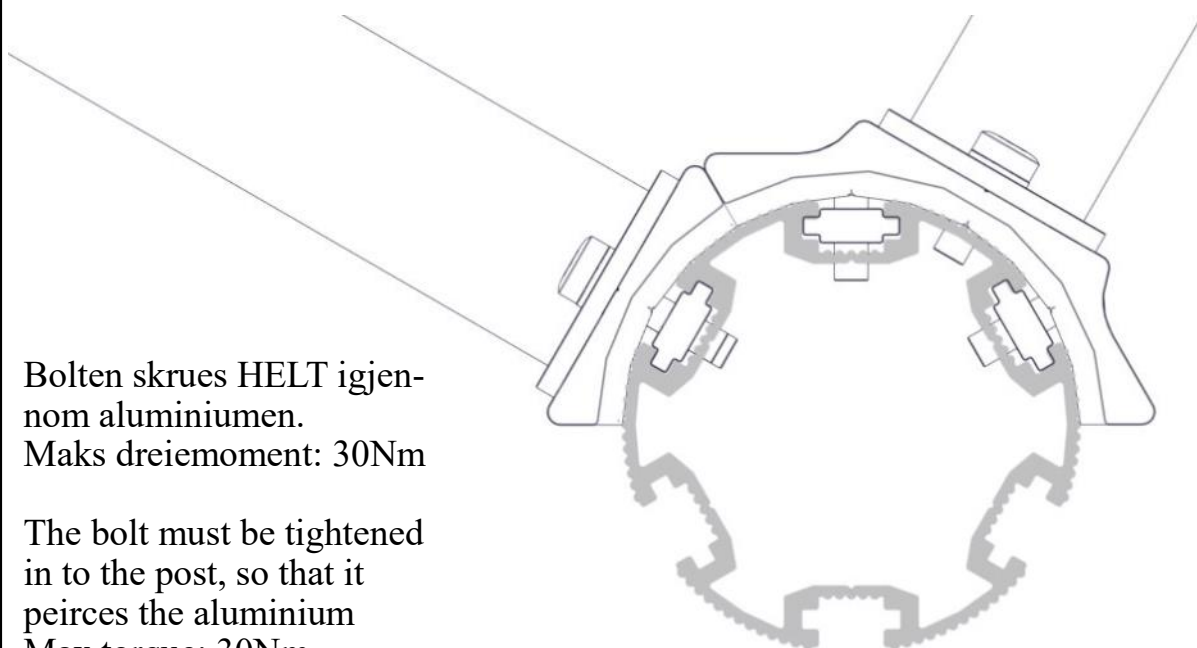

**Fallhøyder / Free height of fall / Fallhöjder**



**Sikkerhetszone / Safety zone / Säkerhetszon**

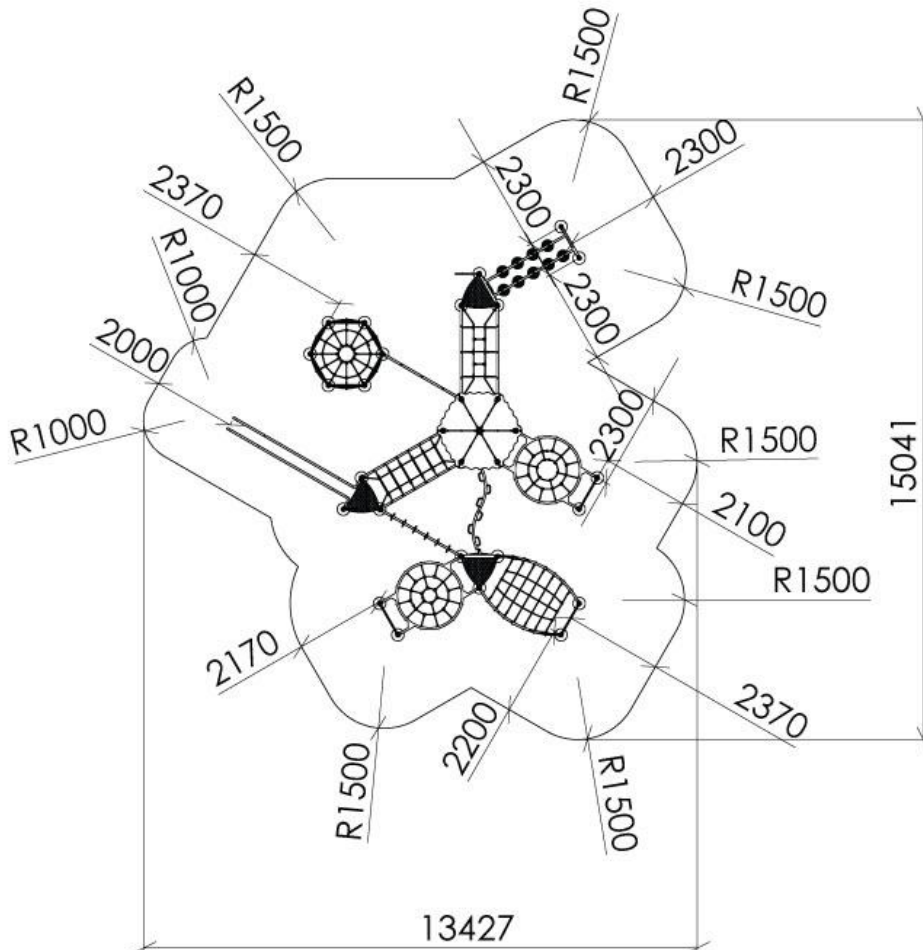

**Plassering av forankringer / Ground plan / Placering av förankringar**

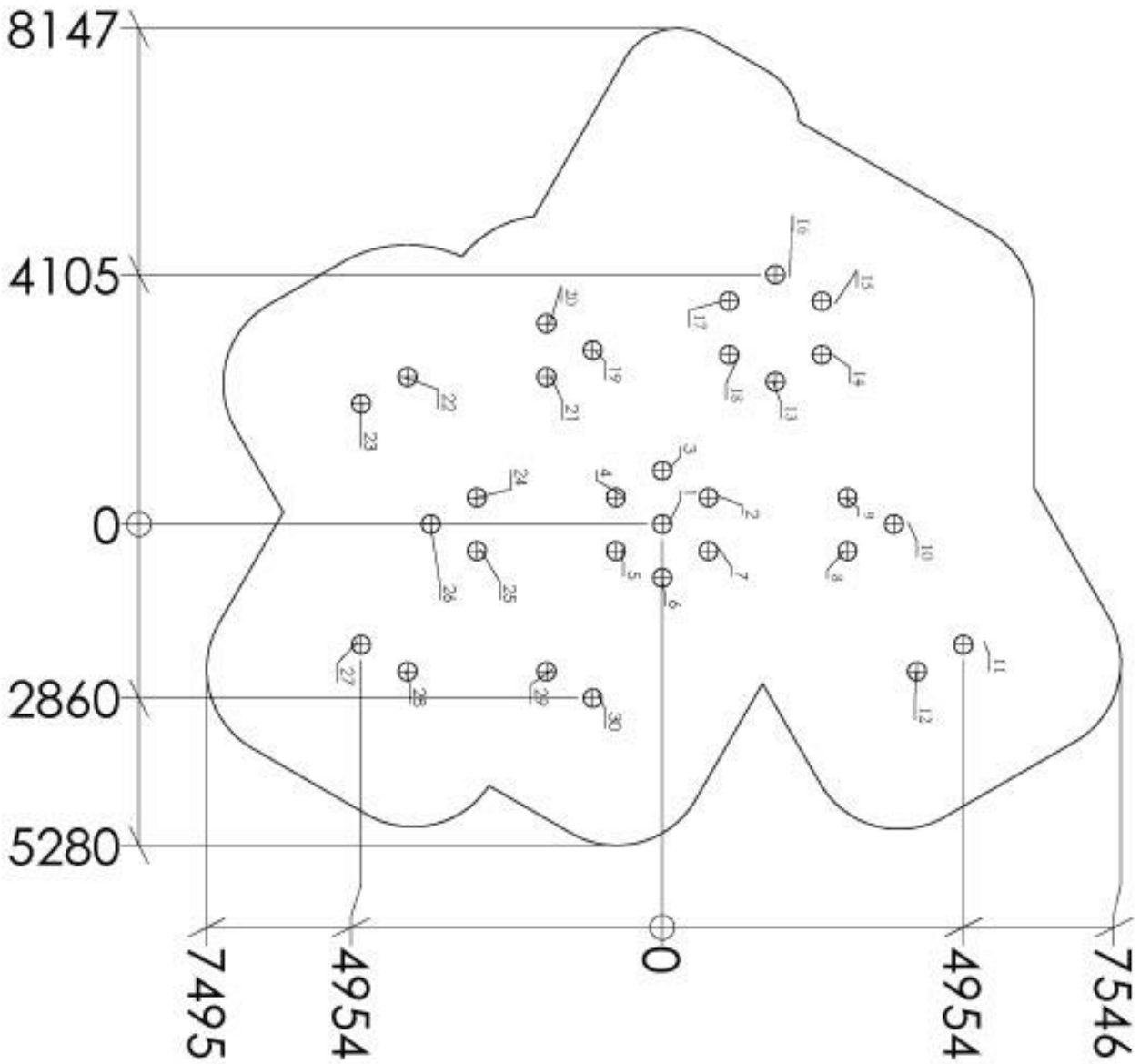

N

Alle mål er oppgitt i millimeter

EN

Scale measured in mm

S

Alla mått är i millimeter.



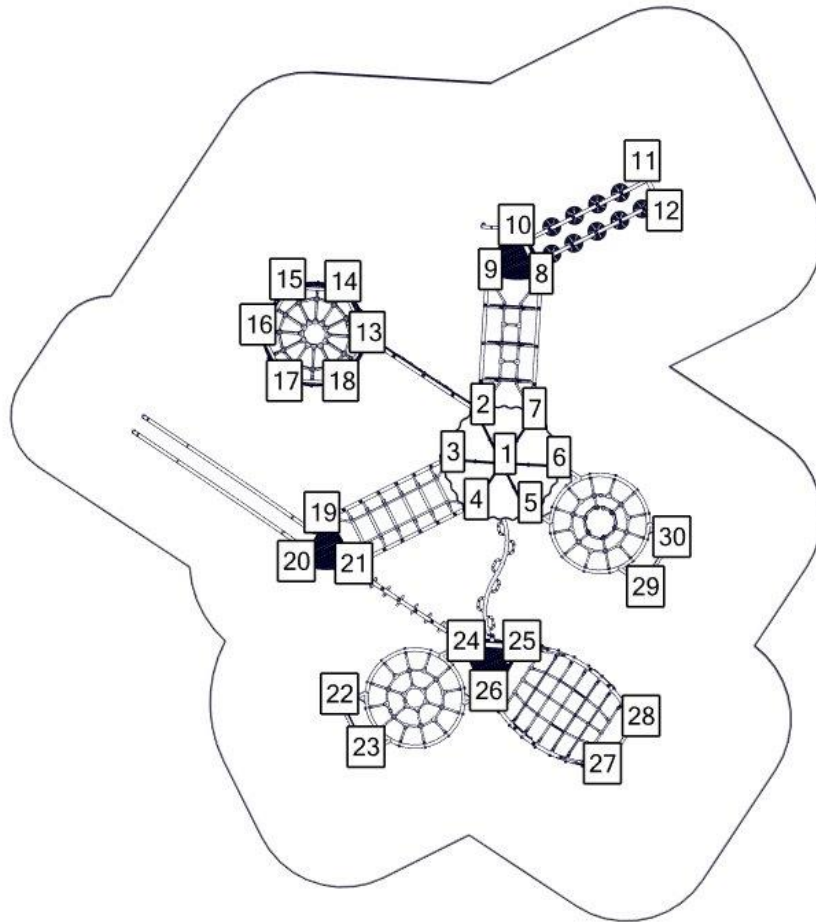

Se separat delmontering for detaljer  
 See separate assembly for details  
 Se separata delmontering för detaljer

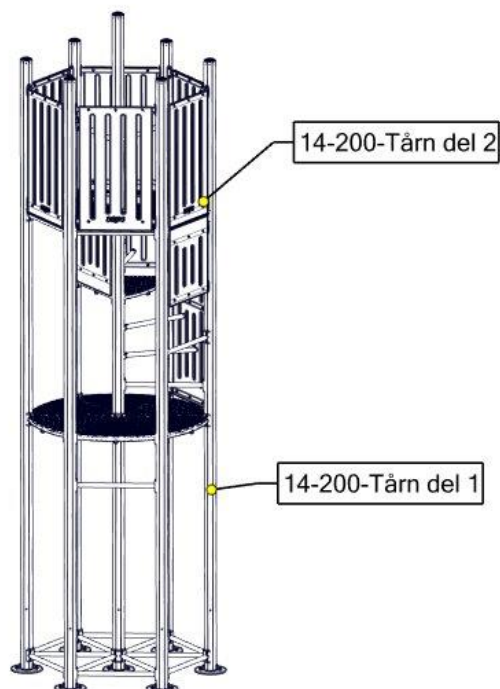

nr	PartName	Artnr	Antall
1	Thorium Tårn	14-200-Tårn	1

Se separat delmontering for detaljer  
 See separate assembly for details  
 Se separata delmontering för detaljer

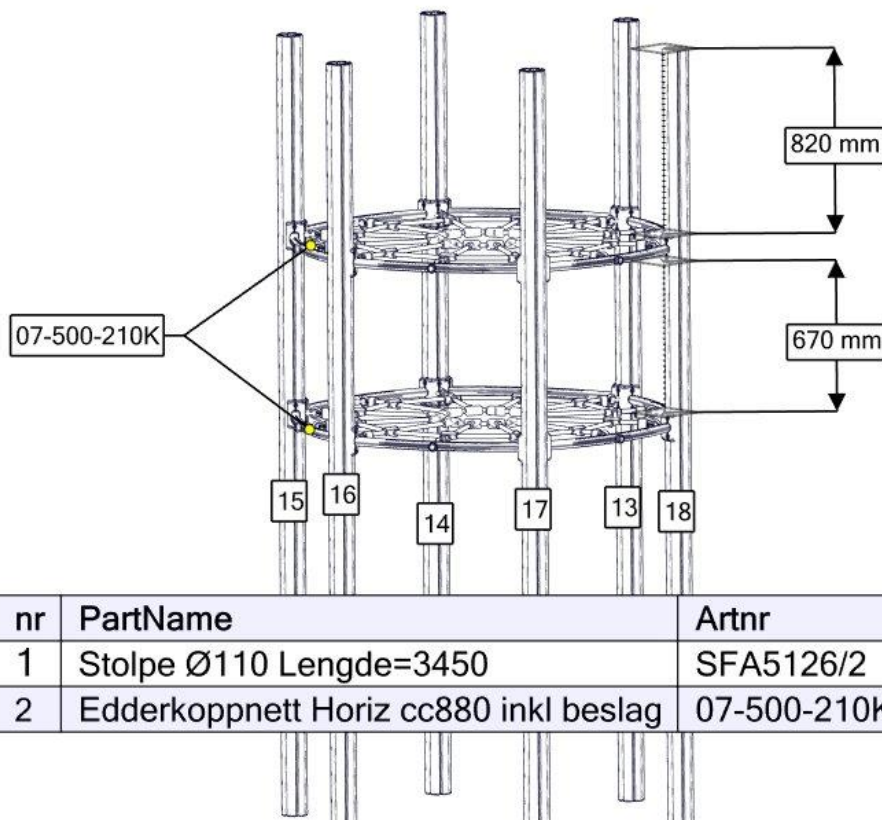

nr	PartName	Artnr	Antall
1	Stolpe Ø110 Lengde=3450	SFA5126/2	6
2	Edderkoppnett Horiz cc880 inkl beslag	07-500-210K	2

Se separat delmontering for detaljer  
 See separate assembly for details  
 Se separata delmontering för detaljer

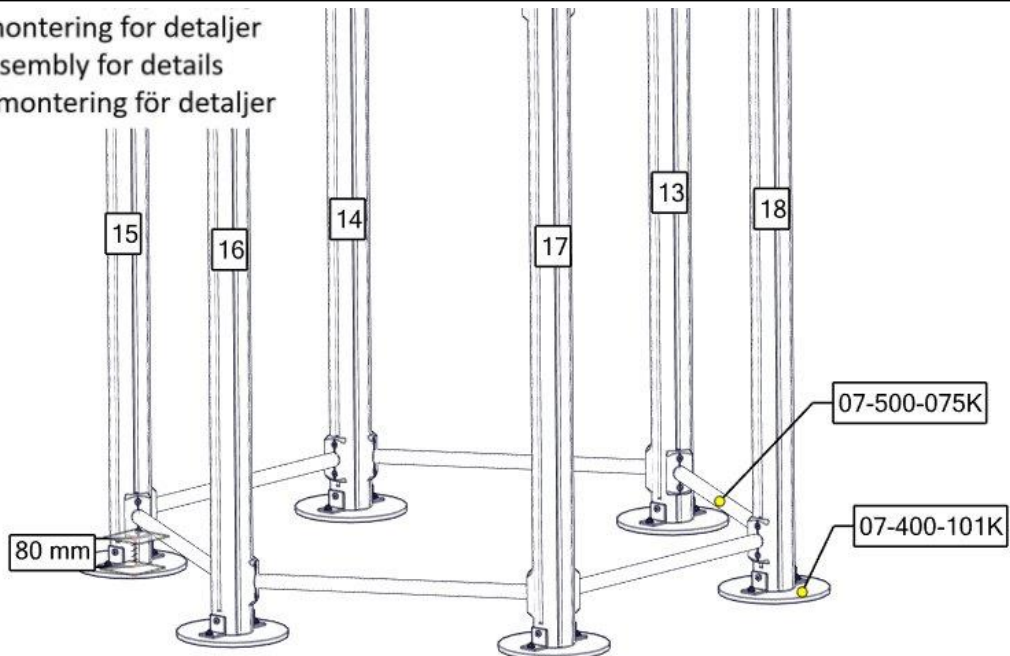

nr	PartName	Artnr	Antall
1	Fundamentplate 1x110 stolpe komplett	07-400-101K	6
2	Sperrerør rett L=750 uten hull	07-500-075K	6

Se separat delmontering for detaljer  
 See separate assembly for details  
 Se separata delmontering för detaljer

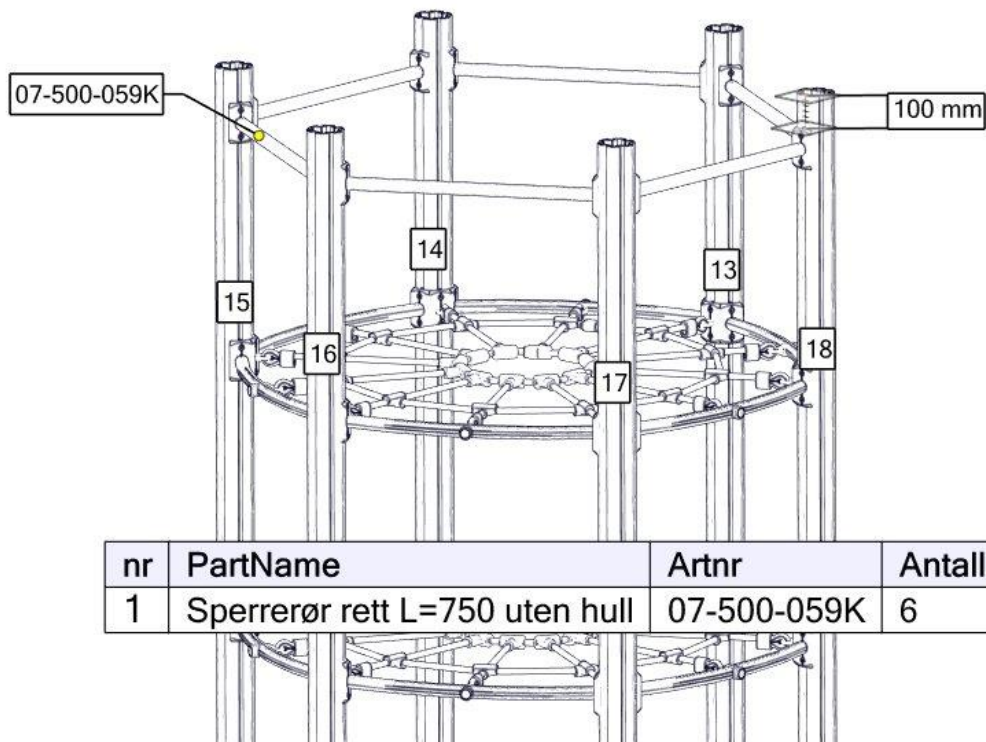

nr	PartName	Artnr	Antall
1	Sperrerør rett L=750 uten hull	07-500-059K	6

Se separat delmontering for detaljer  
 See separate assembly for details  
 Se separata delmontering för detaljer

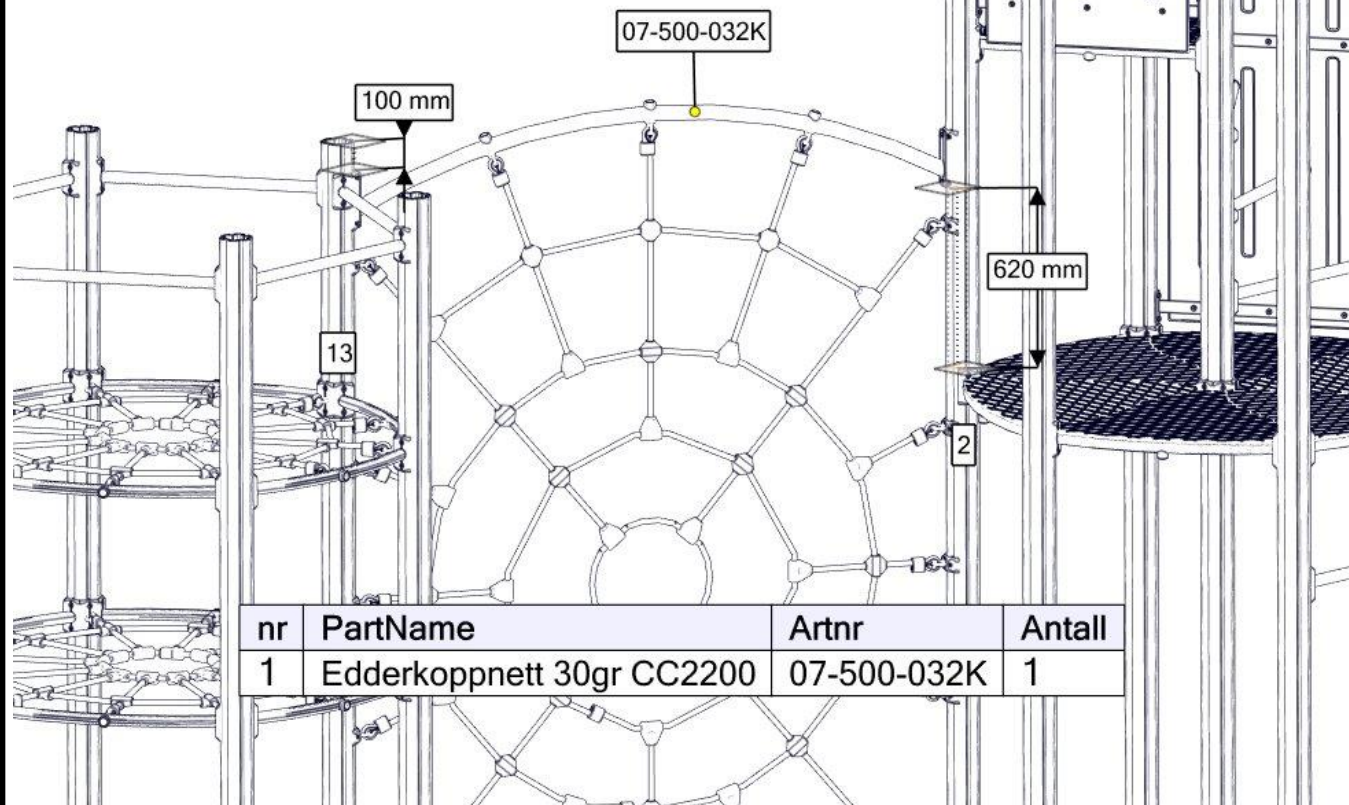

nr	PartName	Artnr	Antall
1	Edderkoppnett 30gr CC2200	07-500-032K	1



Se separat delmontering for detaljer  
 See separate assembly for details  
 Se separata delmontering för detaljer

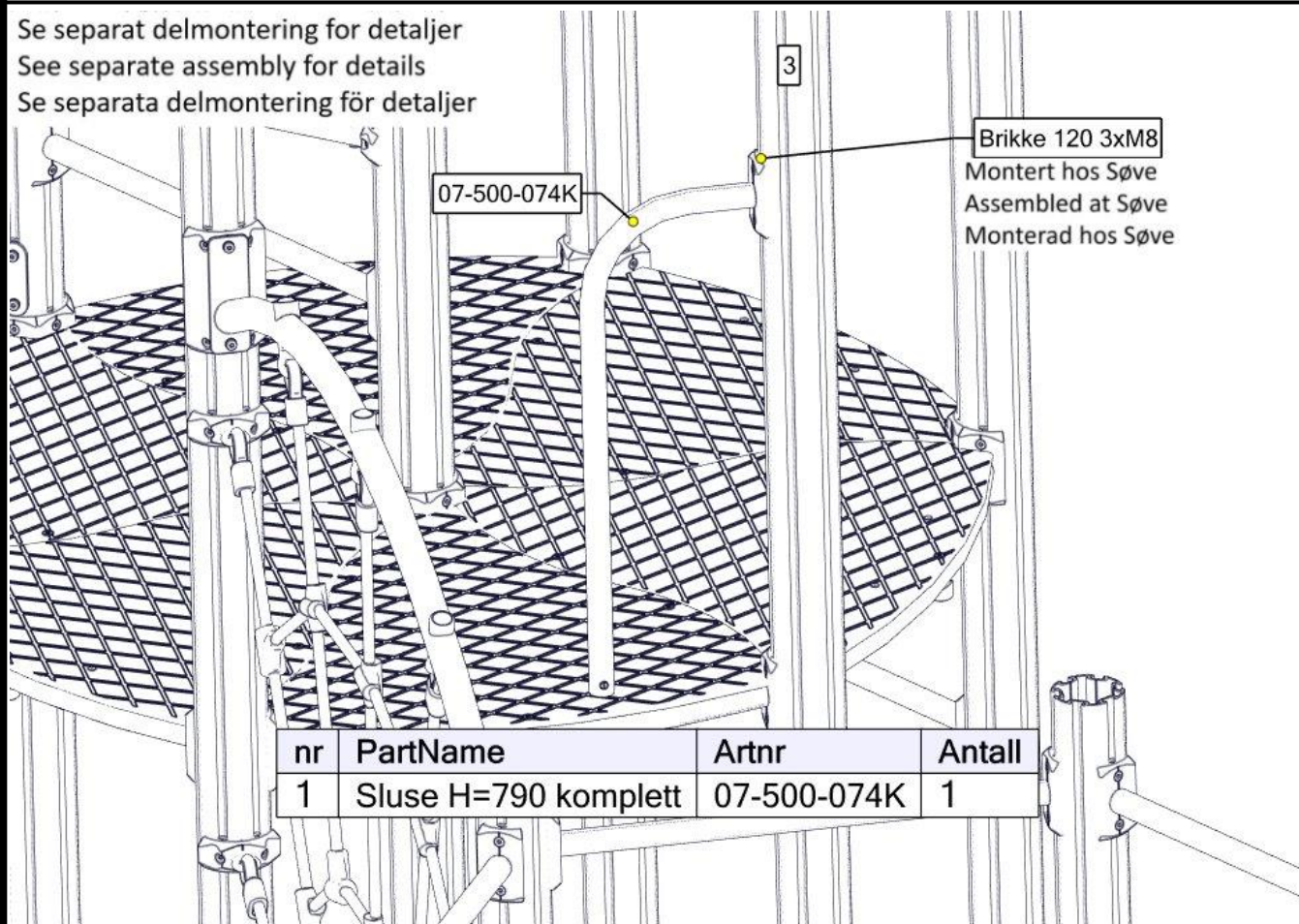

nr	PartName	Artnr	Antall
1	Sluse H=790 komplett	07-500-074K	1

Se separat delmontering for detaljer  
 See separate assembly for details  
 Se separata delmontering för detaljer

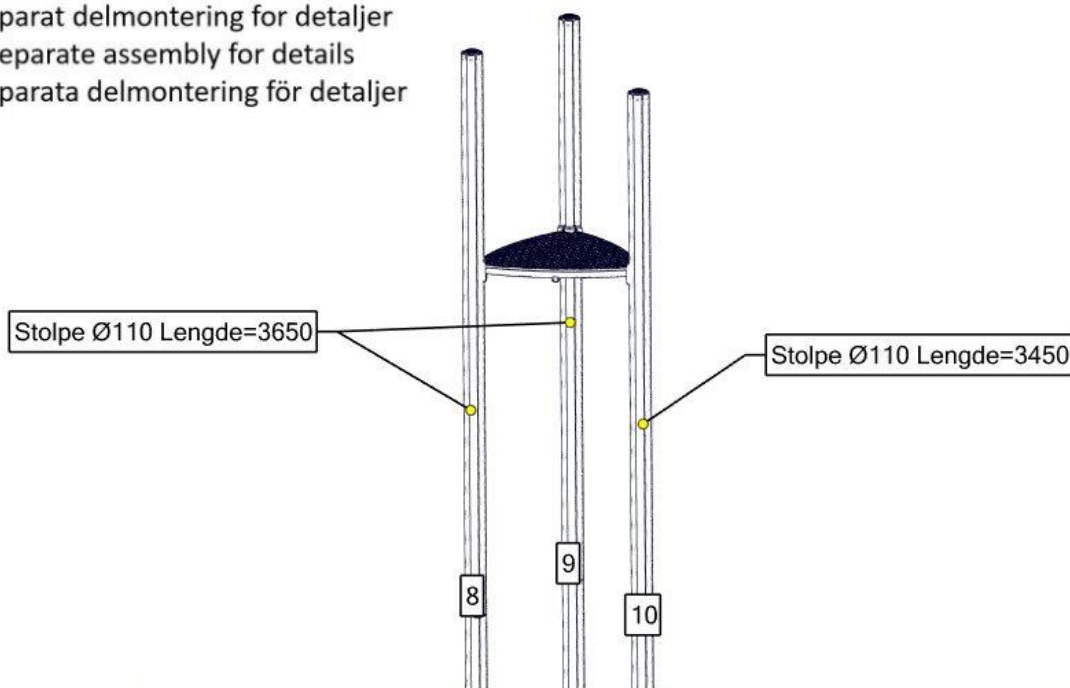

nr	PartName	Artnr	Antall
1	Gulv 3-kant 880x880 Standard	07-300-104K	1
2	Stolpe Ø110 Lengde=3650	SFA5126/2	2
3	Stolpe Ø110 Lengde=3450	SFA5126/2	1

Se separat delmontering for detaljer  
 See separate assembly for details  
 Se separata delmontering för detaljer

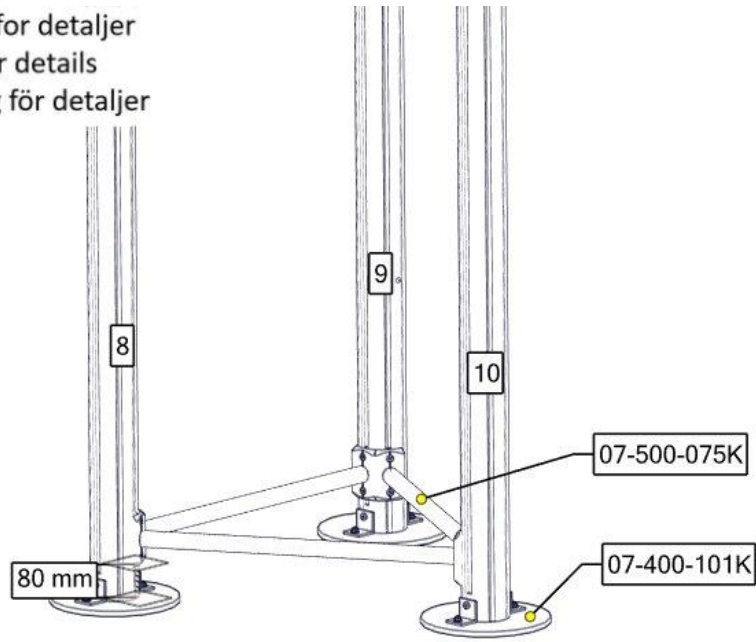

nr	PartName	Artnr	Antall
1	Sperrør rett L=750 uten hull	07-500-075K	3
2	Fundamentplate 1x110 stolpe komplett	07-400-101K	3

Se separat delmontering for detaljer  
 See separate assembly for details  
 Se separata delmontering för detaljer

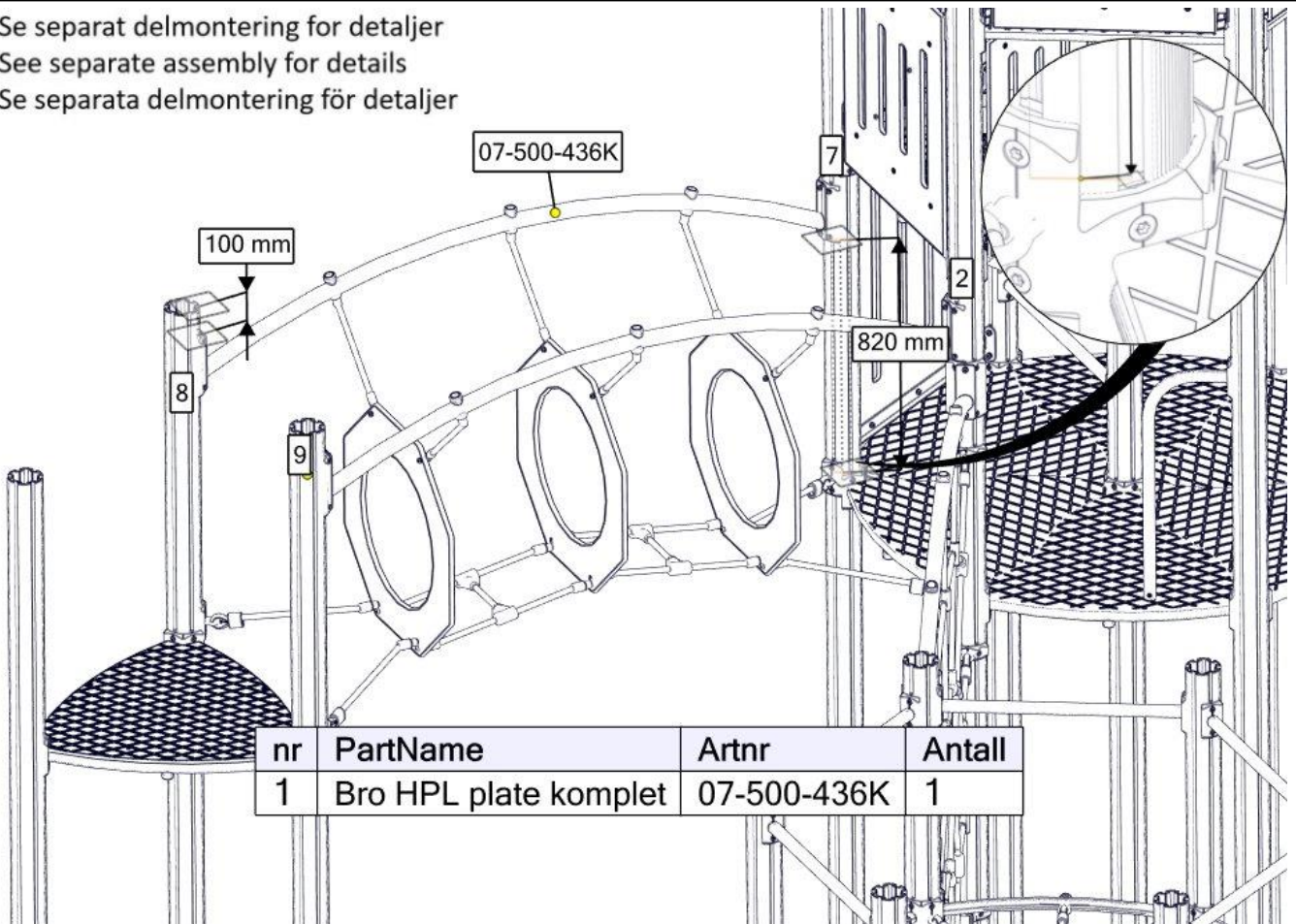

nr	PartName	Artnr	Antall
1	Bro HPL plate komplet	07-500-436K	1



Se separat delmontering for detaljer  
 See separate assembly for details  
 Se separata delmontering för detaljer

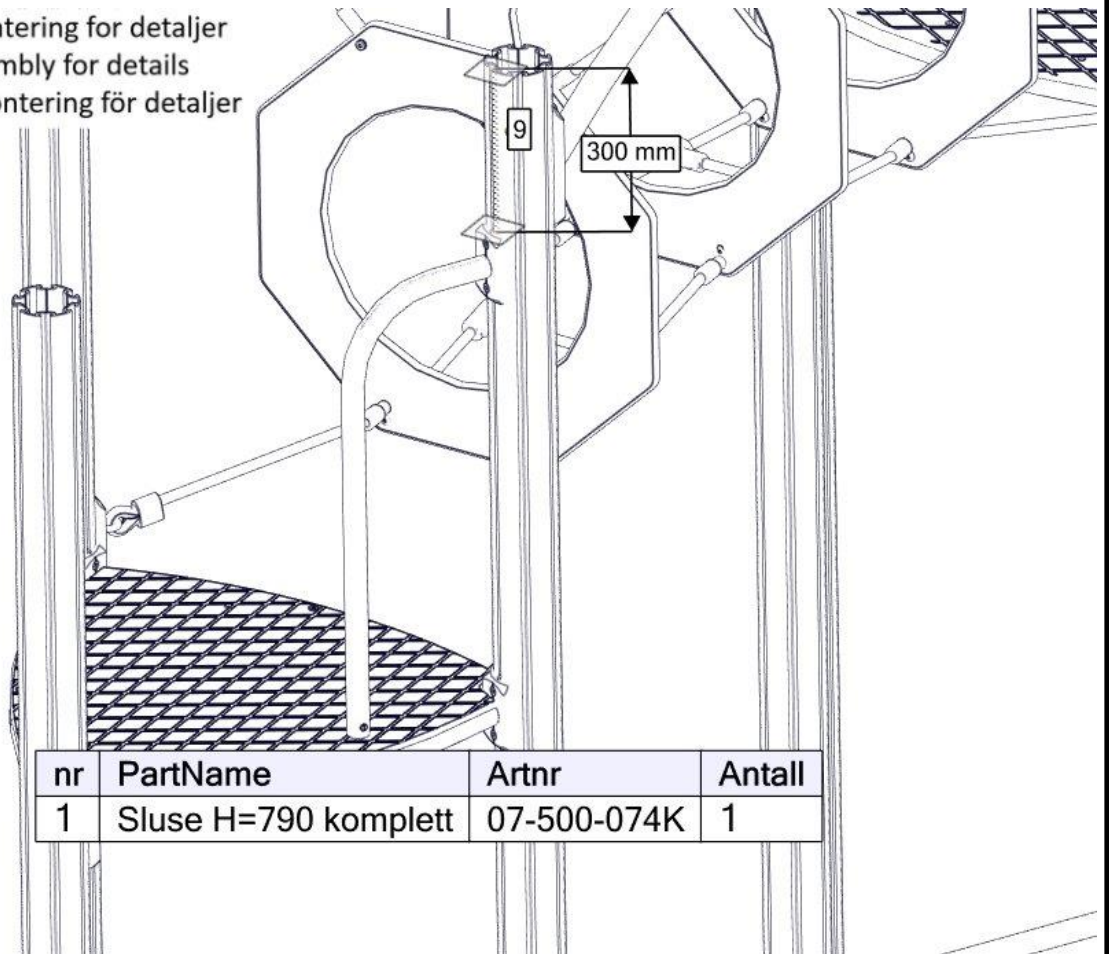

nr	PartName	Artnr	Antall
1	Sluse H=790 komplett	07-500-074K	1

Se separat delmontering for detaljer  
 See separate assembly for details  
 Se separata delmontering för detaljer

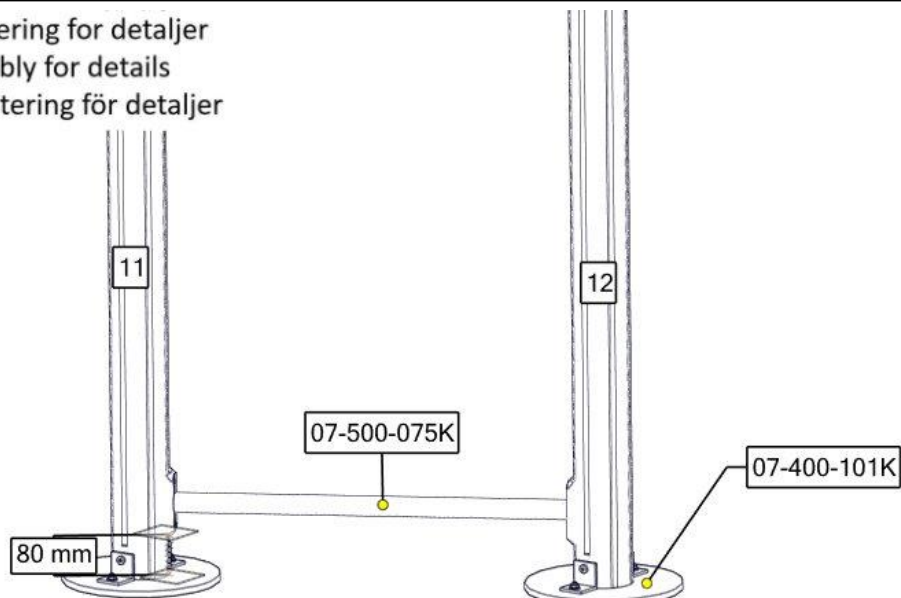

nr	PartName	Artnr	Antall
1	Sperrerør rett L=750 uten hull	07-500-075K	1
2	Fundamentplate 1x110 stolpe komplett	07-400-101K	2
3	Stolpe Ø110 Lengde=3450	SFA5126/2	2

Se separat delmontering for detaljer  
 See separate assembly for details  
 Se separata delmontering för detaljer

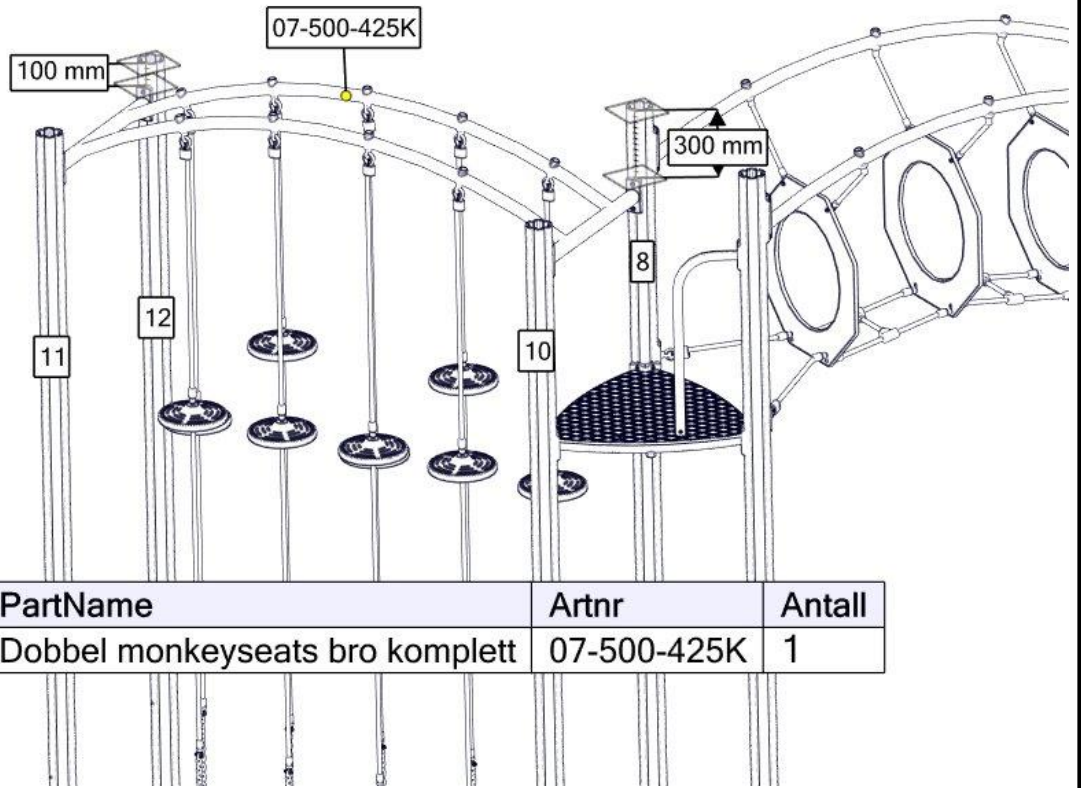

nr	PartName	Artnr	Antall
1	Dobbel monkeyseats bro komplett	07-500-425K	1

Se separat delmontering for detaljer  
 See separate assembly for details  
 Se separata delmontering för detaljer

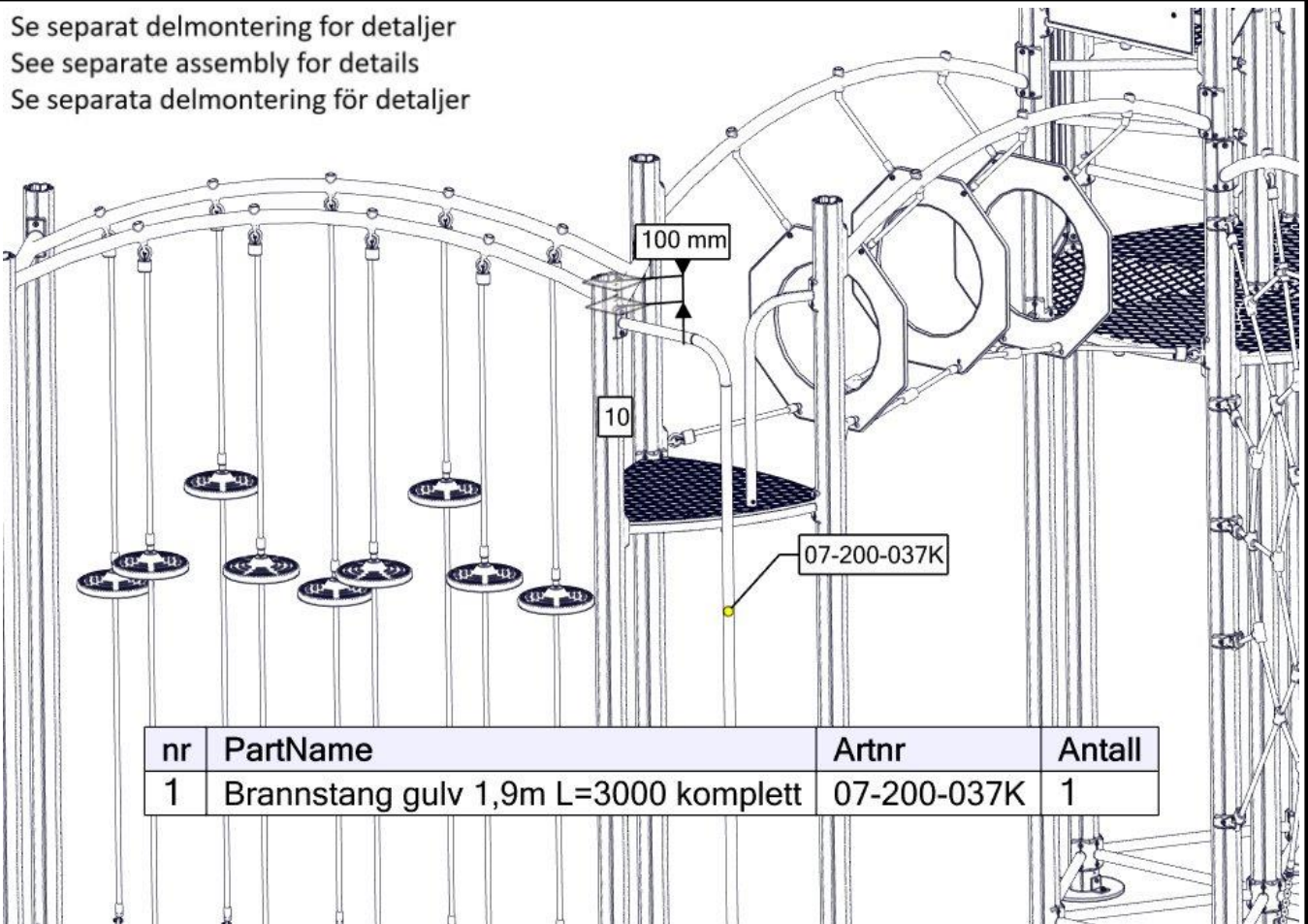

nr	PartName	Artnr	Antall
1	Brannstang gulv 1,9m L=3000 komplett	07-200-037K	1

Se separat delmontering for detaljer  
 See separate assembly for details  
 Se separata delmontering för detaljer

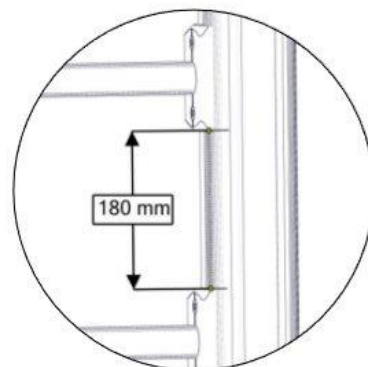
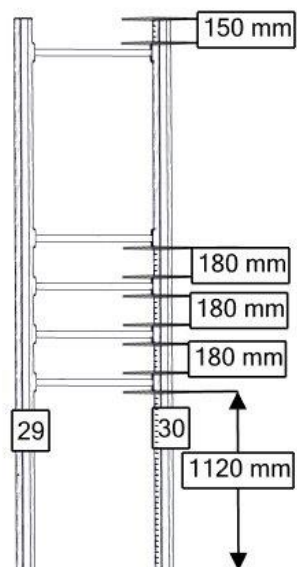

nr	PartName	Artnr	Antall
1	Stolpe Ø110 Lengde=3450	SFA5126/2	2
2	Sperrør rett L=750 uten hull	07-500-059K	5

Se separat delmontering for detaljer  
 See separate assembly for details  
 Se separata delmontering för detaljer

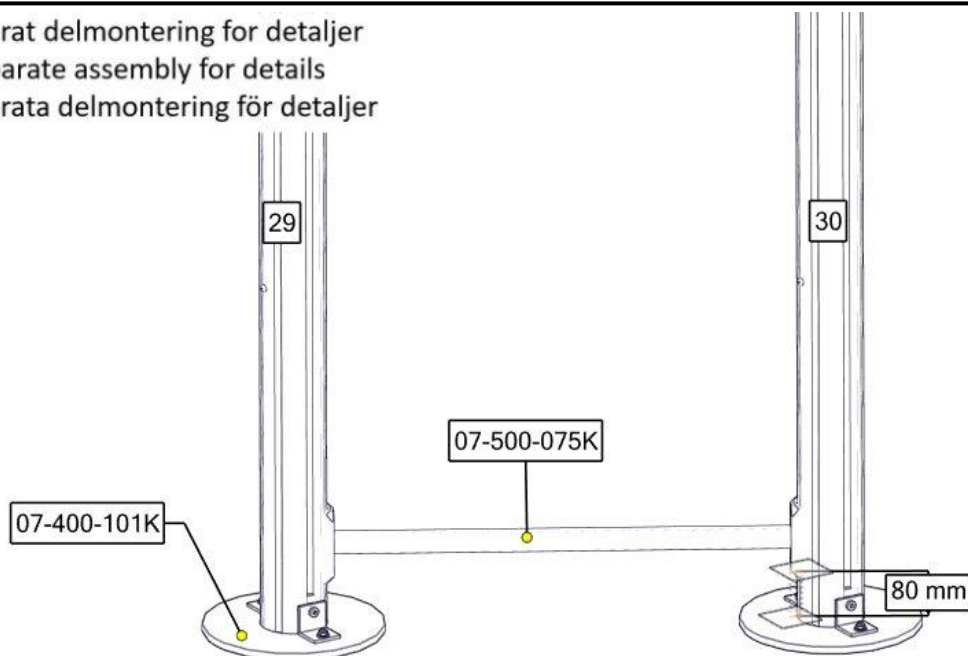

nr	PartName	Artnr	Antall
1	Sperrør rett L=750 uten hull	07-500-075K	1
2	Fundamentplate 1x110 stolpe komplett	07-400-101K	2



Se separat delmontering for detaljer  
 See separate assembly for details  
 Se separata delmontering för detaljer

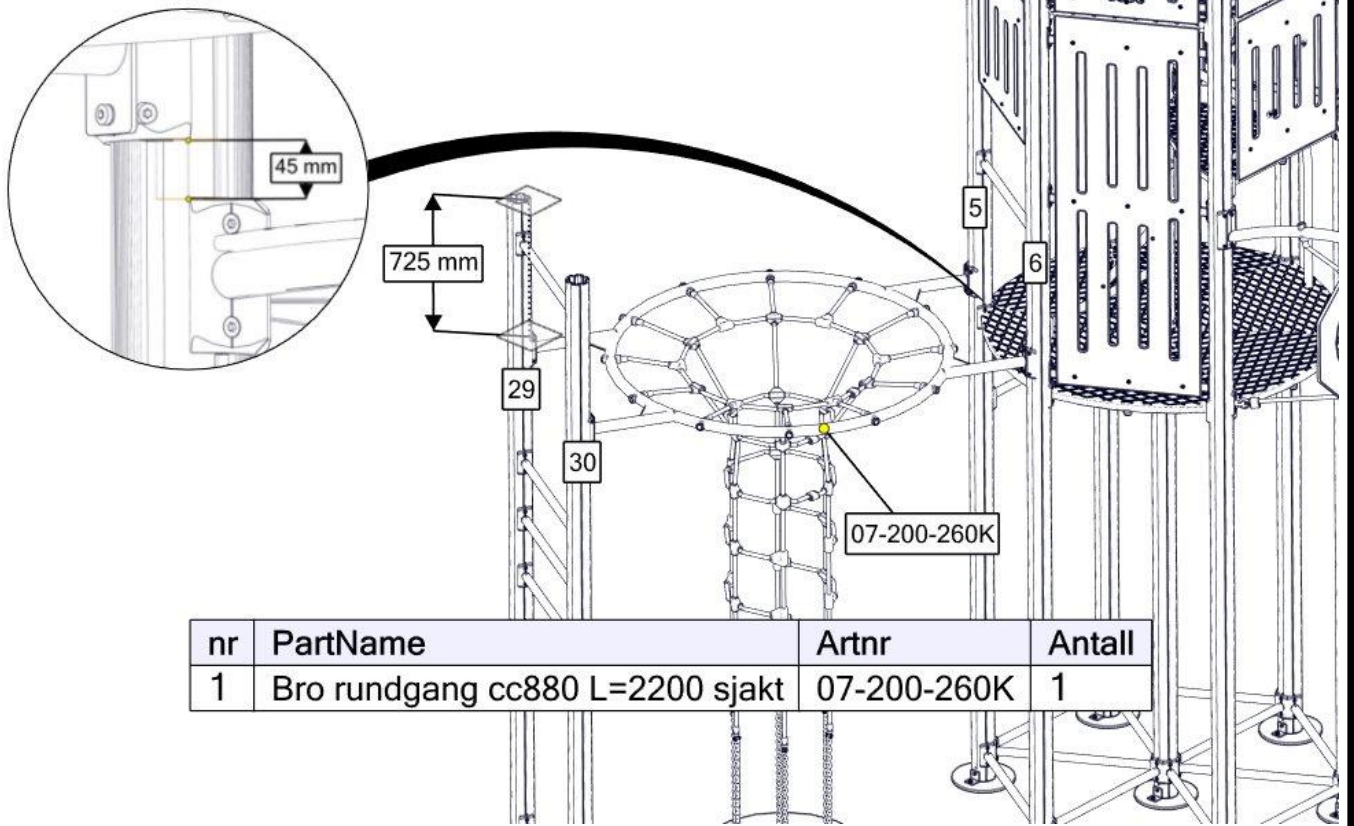

nr	PartName	Artnr	Antall
1	Bro rundgang cc880 L=2200 sjakt	07-200-260K	1

Se separat delmontering for detaljer  
 See separate assembly for details  
 Se separata delmontering för detaljer

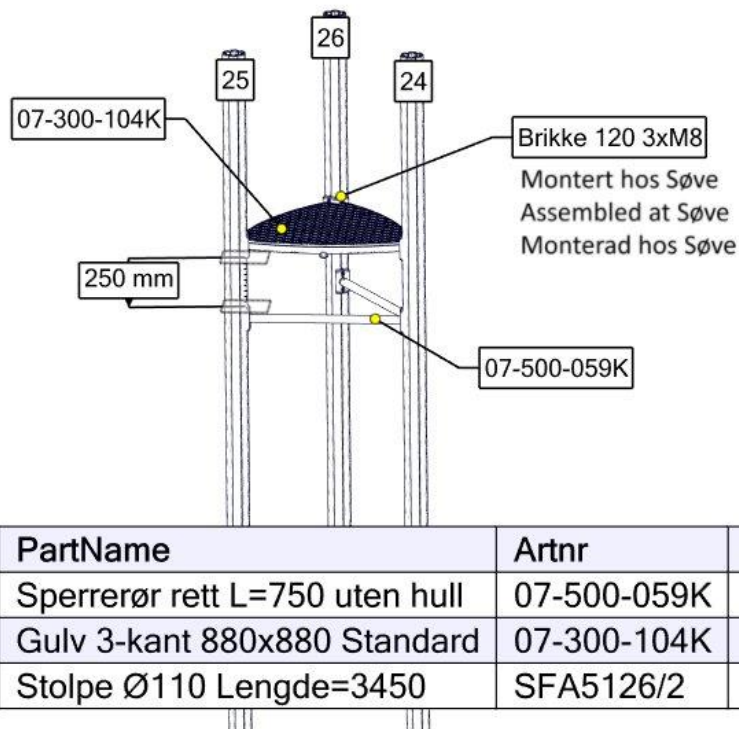

nr	PartName	Artnr	Antall
1	Sperrerør rett L=750 uten hull	07-500-059K	2
2	Gulv 3-kant 880x880 Standard	07-300-104K	1
3	Stolpe Ø110 Lengde=3450	SFA5126/2	3

Se separat delmontering for detaljer  
 See separate assembly for details  
 Se separata delmontering för detaljer

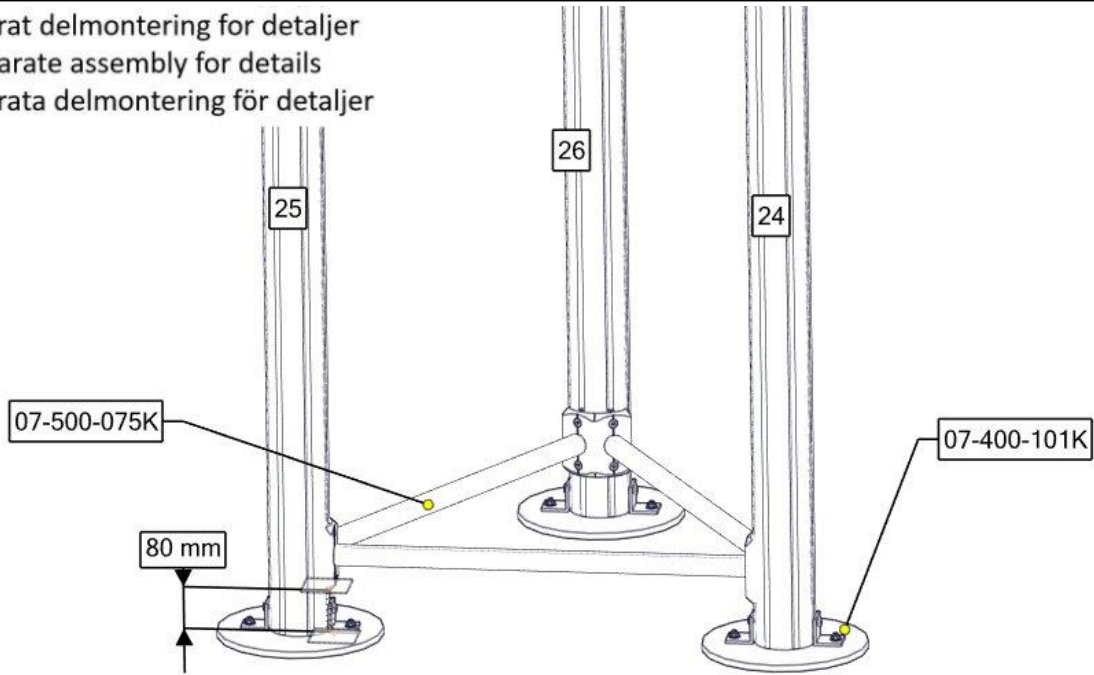

nr	PartName	Artnr	Antall
1	Fundamentplate 1x110 stolpe komplett	07-400-101K	3
2	Sperrerør rett L=750 uten hull	07-500-075K	3

Se separat delmontering for detaljer  
 See separate assembly for details  
 Se separata delmontering för detaljer

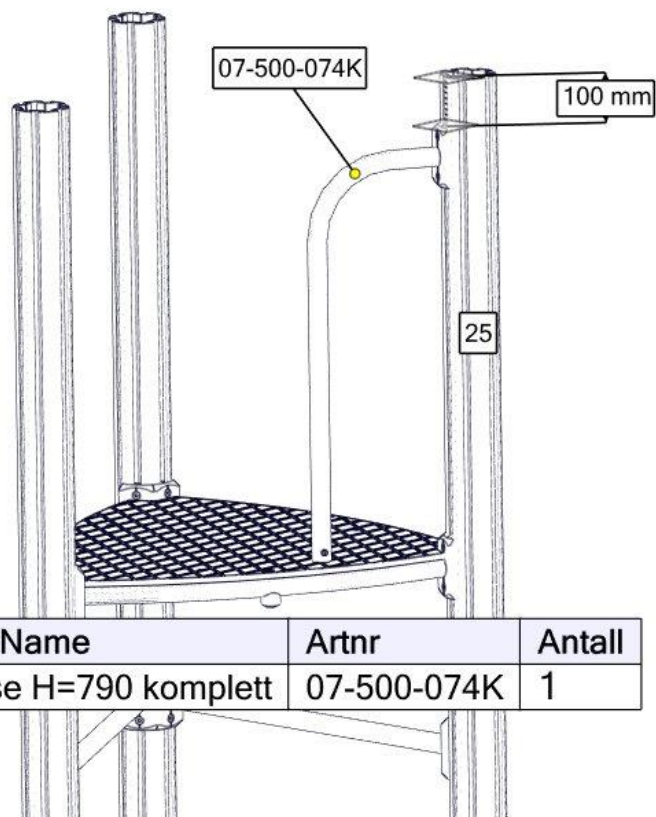

nr	PartName	Artnr	Antall
1	Sluse H=790 komplett	07-500-074K	1



Se separat delmontering for detaljer  
 See separate assembly for details  
 Se separata delmontering för detaljer

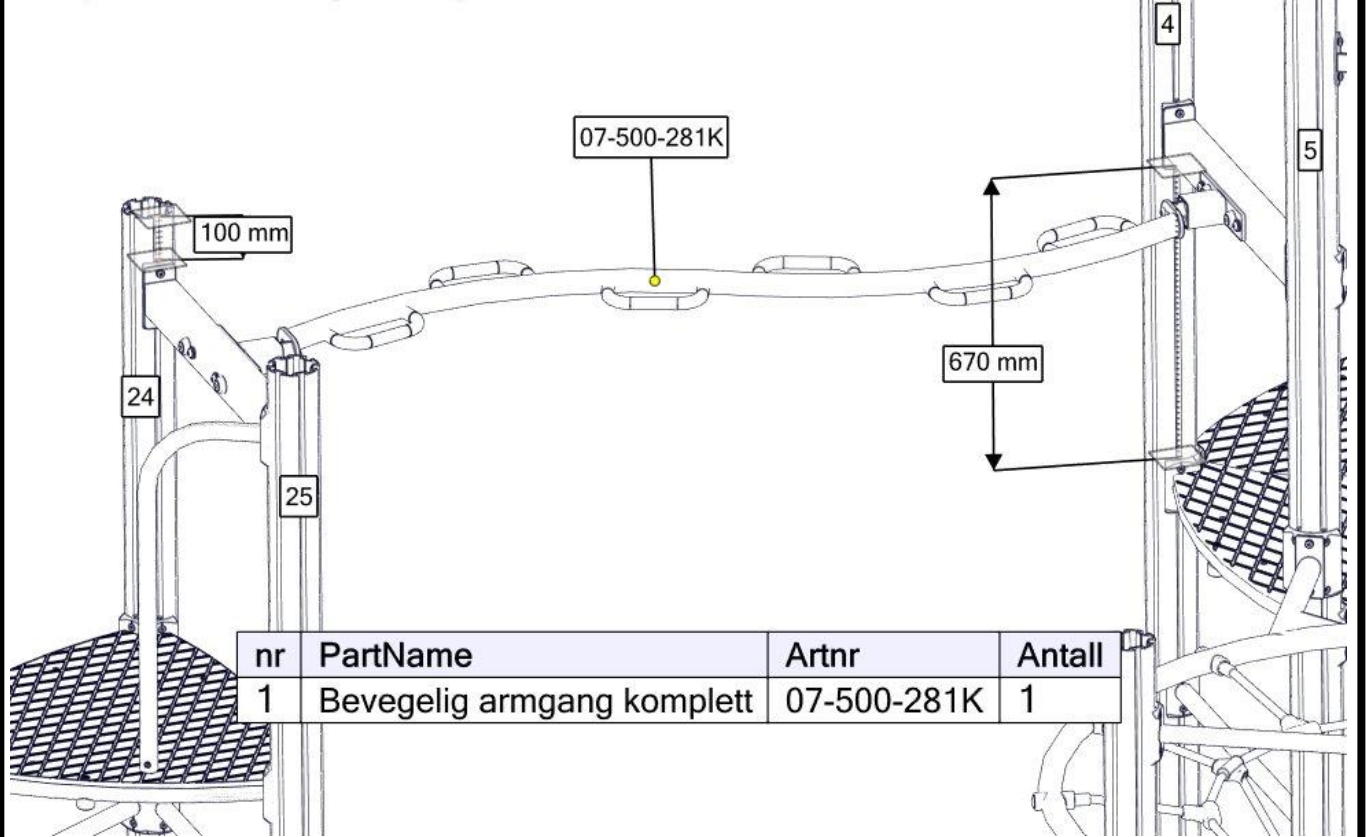

Se separat delmontering for detaljer  
 See separate assembly for details  
 Se separata delmontering för detaljer

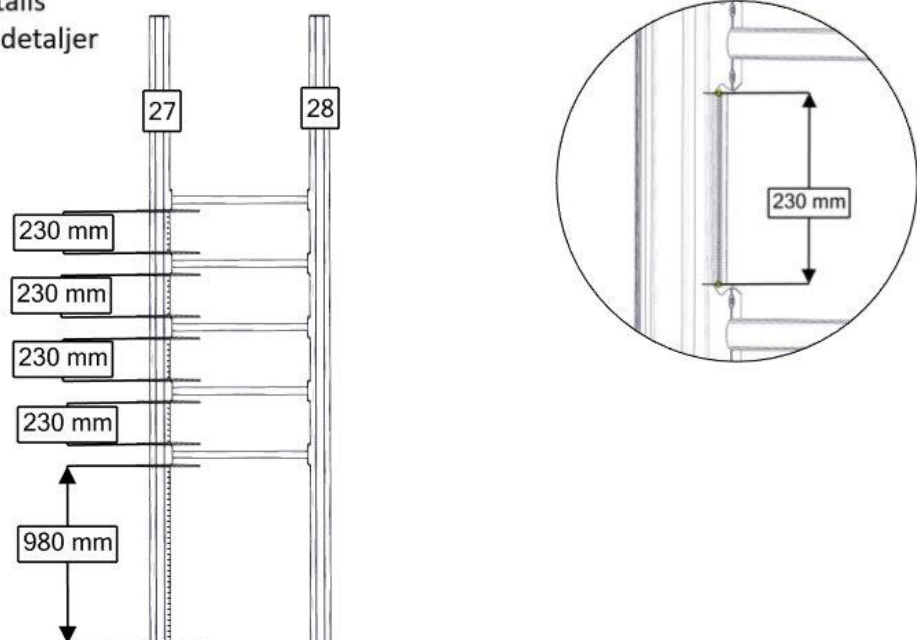

nr	PartName	Artnr	Antall
1	Sperrerør rett L=750 uten hull	07-500-059K	5
2	Stolpe Ø110 Lengde=3450	SFA5126/2	2

Se separat delmontering for detaljer  
 See separate assembly for details  
 Se separata delmontering för detaljer

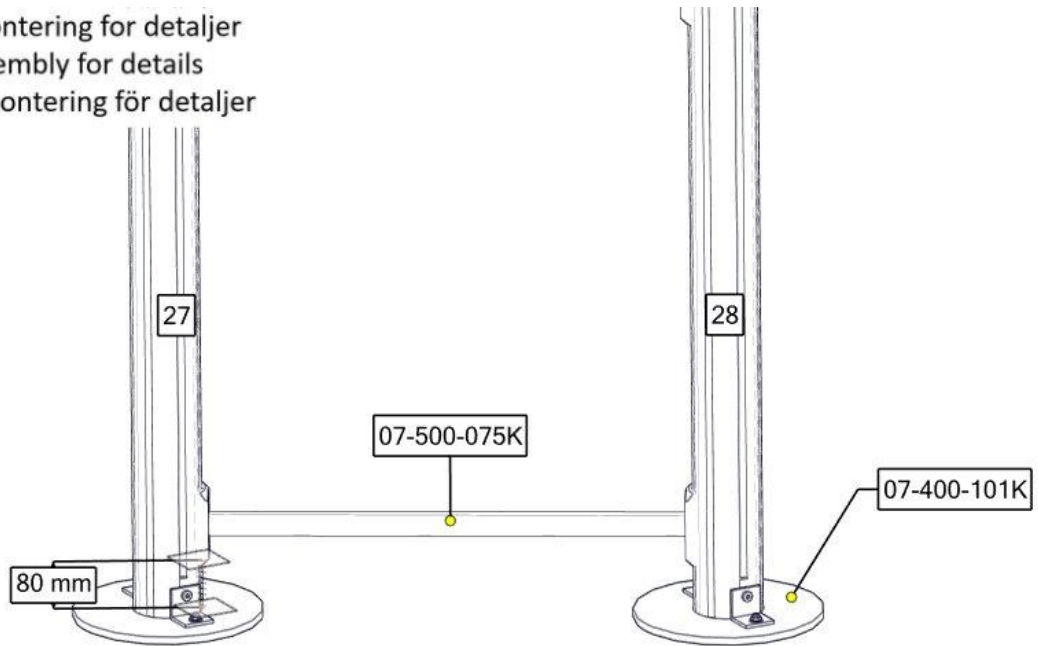

nr	PartName	Artnr	Antall
1	Fundamentplate 1x110 stolpe komplett	07-400-101K	2
2	Sperrerør rett L=750 uten hull	07-500-075K	1

Se separat delmontering for detaljer  
 See separate assembly for details  
 Se separata delmontering för detaljer

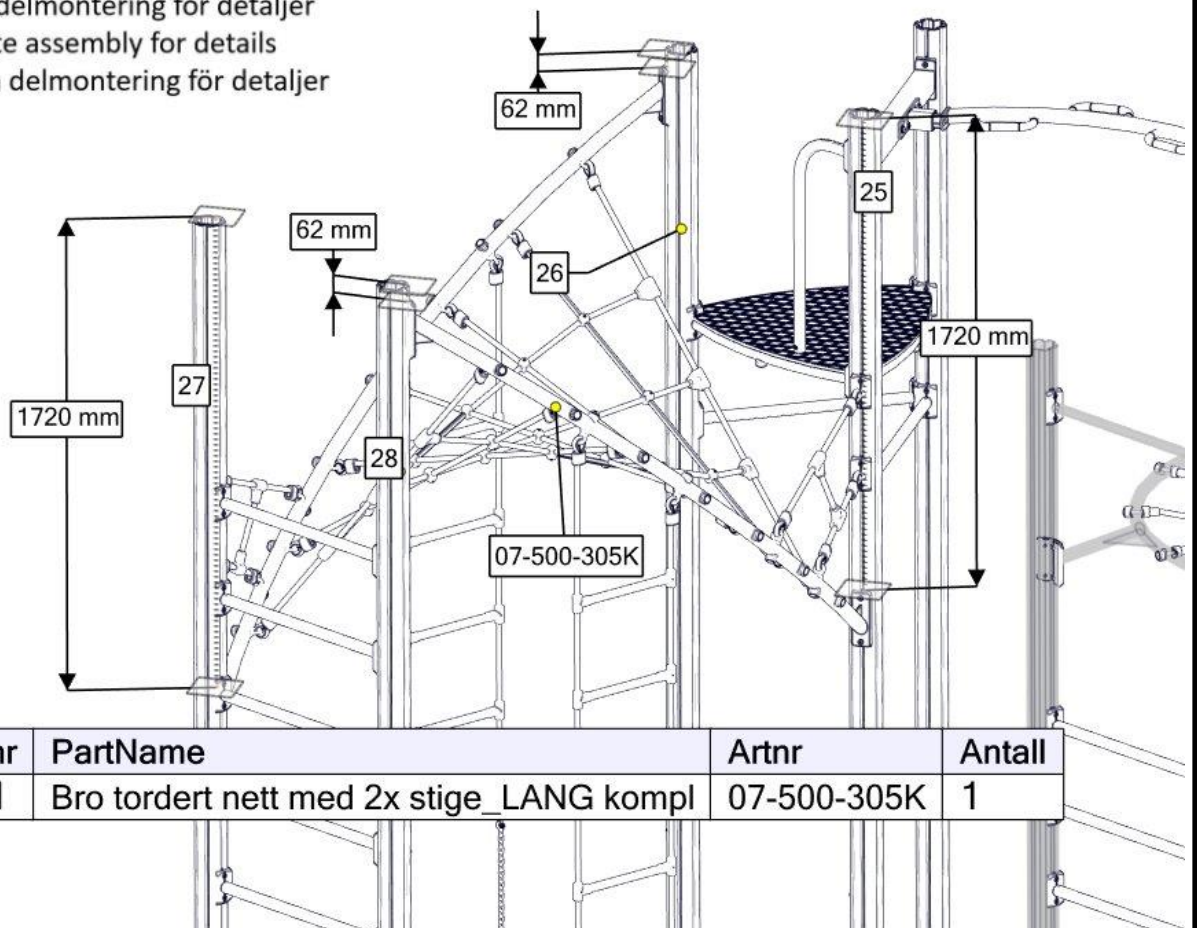

nr	PartName	Artnr	Antall
1	Bro tordert nett med 2x stige LANG kompl	07-500-305K	1

Se separat delmontering for detaljer  
 See separate assembly for details  
 Se separata delmontering för detaljer

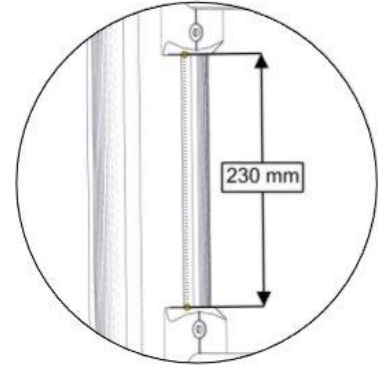
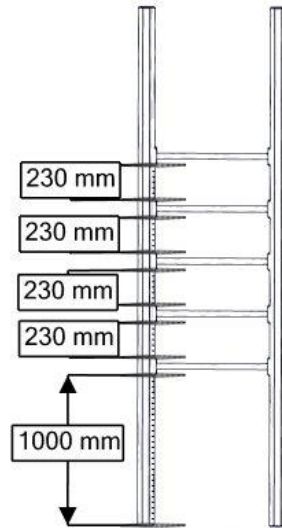

nr	PartName	Artnr	Antall
1	Sperrerør rett	n/a	5
2	Stolpe L=3450	07-100-334	2

Se separat delmontering for detaljer  
 See separate assembly for details  
 Se separata delmontering för detaljer

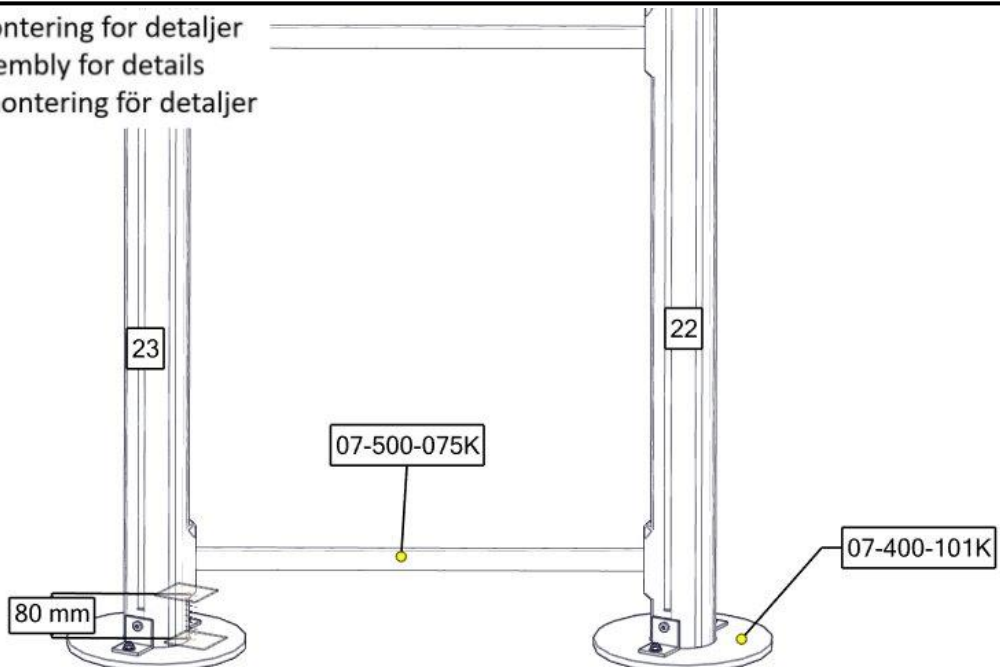

nr	PartName	Artnr	Antall
1	Sperrerør rett L=750 uten hull	07-500-075K	1
2	Fundamentplate 1x110 stolpe komplett	07-400-101K	2



Se separat delmontering for detaljer  
 See separate assembly for details  
 Se separata delmontering för detaljer

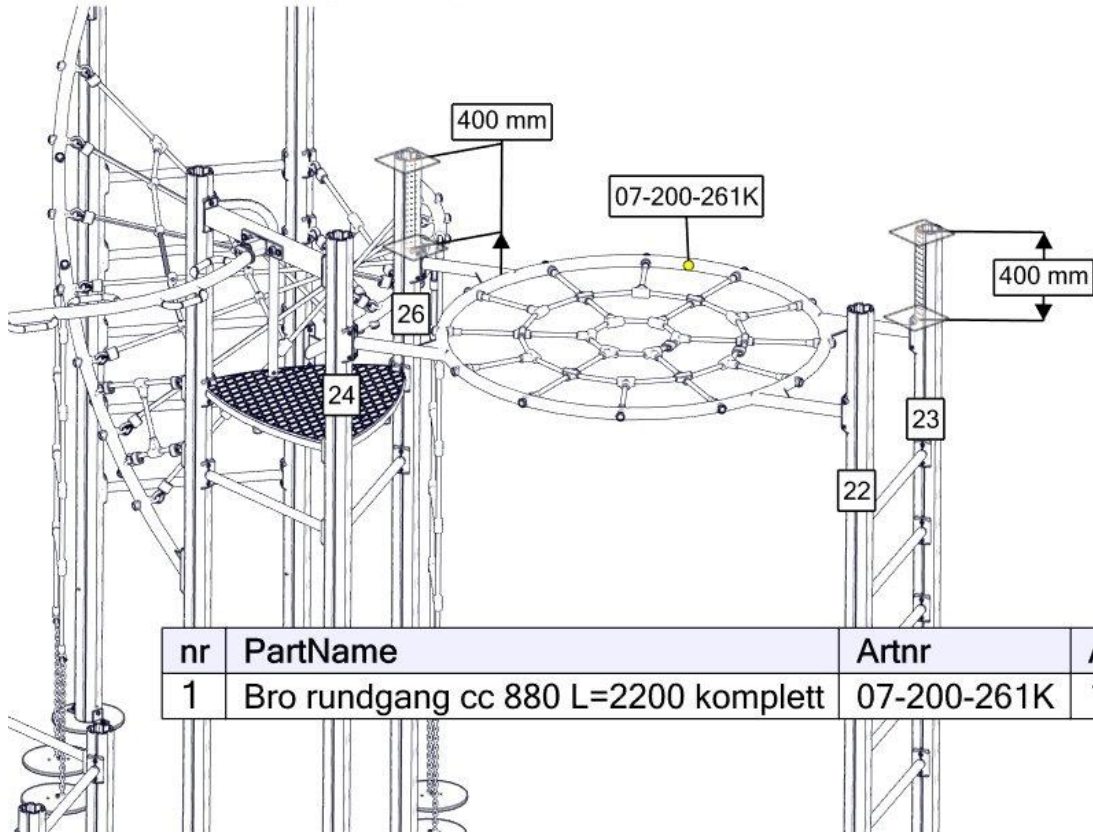

Se separat delmontering for detaljer  
 See separate assembly for details  
 Se separata delmontering för detaljer

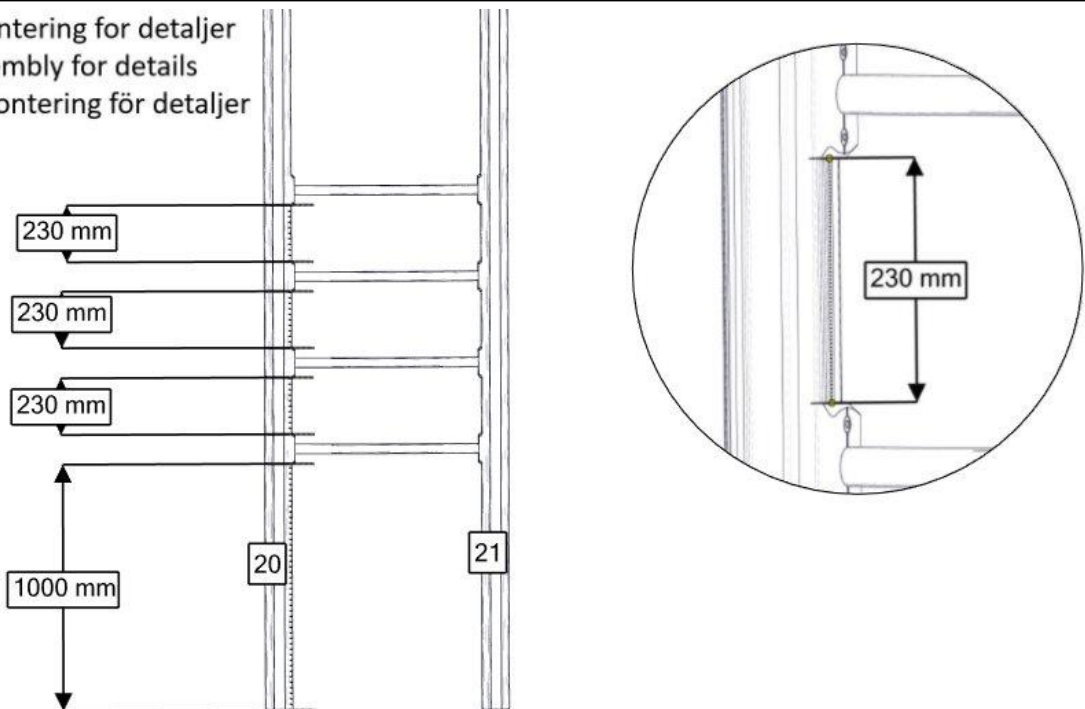

nr	PartName	Artnr	Antall
1	Sperrerør Bøyd L=750 uten hull	07-500-072K	4
2	Stolpe Ø110 Lengde=3450	SFA5126/2	2

Se separat delmontering for detaljer  
 See separate assembly for details  
 Se separata delmontering för detaljer

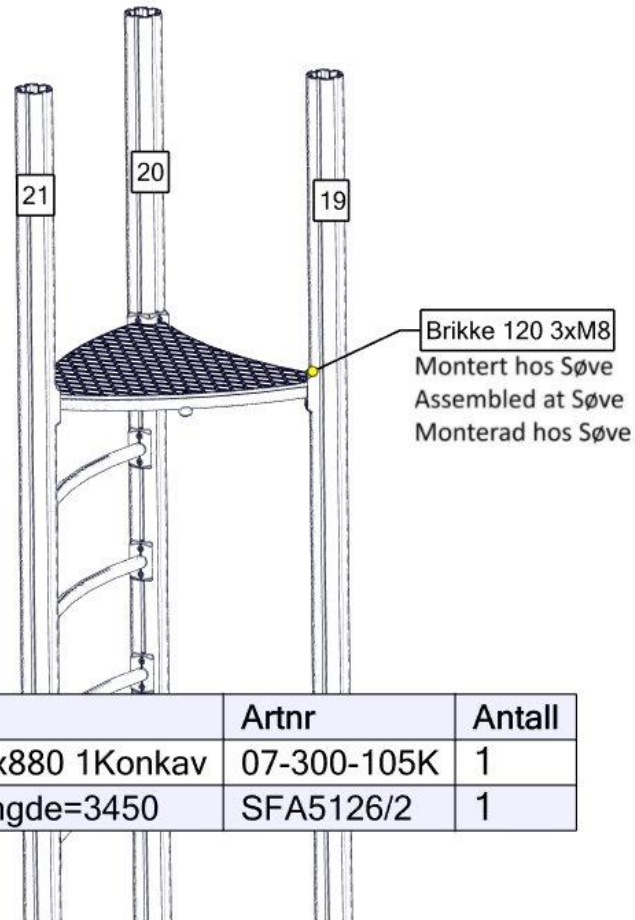

nr	PartName	Artnr	Antall
1	Gulv 3-kant 880x880 1Konkav	07-300-105K	1
2	Stolpe Ø110 Lengde=3450	SFA5126/2	1

Se separat delmontering for detaljer  
 See separate assembly for details  
 Se separata delmontering för detaljer

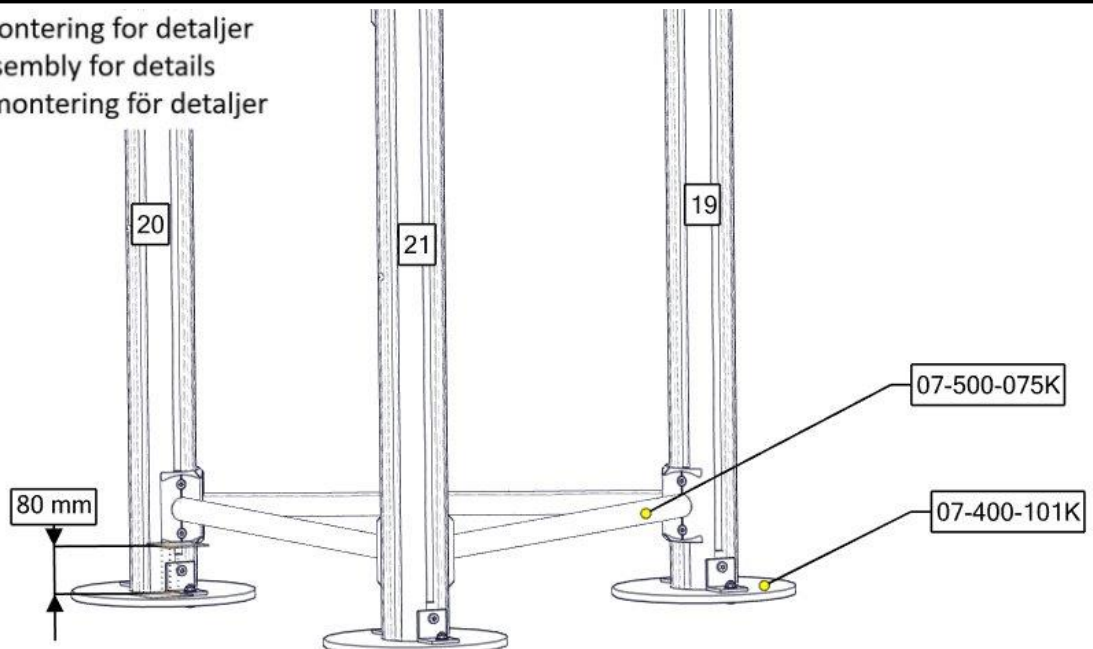

nr	PartName	Artnr	Antall
1	Fundamentplate 1x110 stolpe komplett	07-400-101K	3
2	Sperrerør rett L=750 uten hull	07-500-075K	3



Se separat delmontering for detaljer  
 See separate assembly for details  
 Se separata delmontering för detaljer

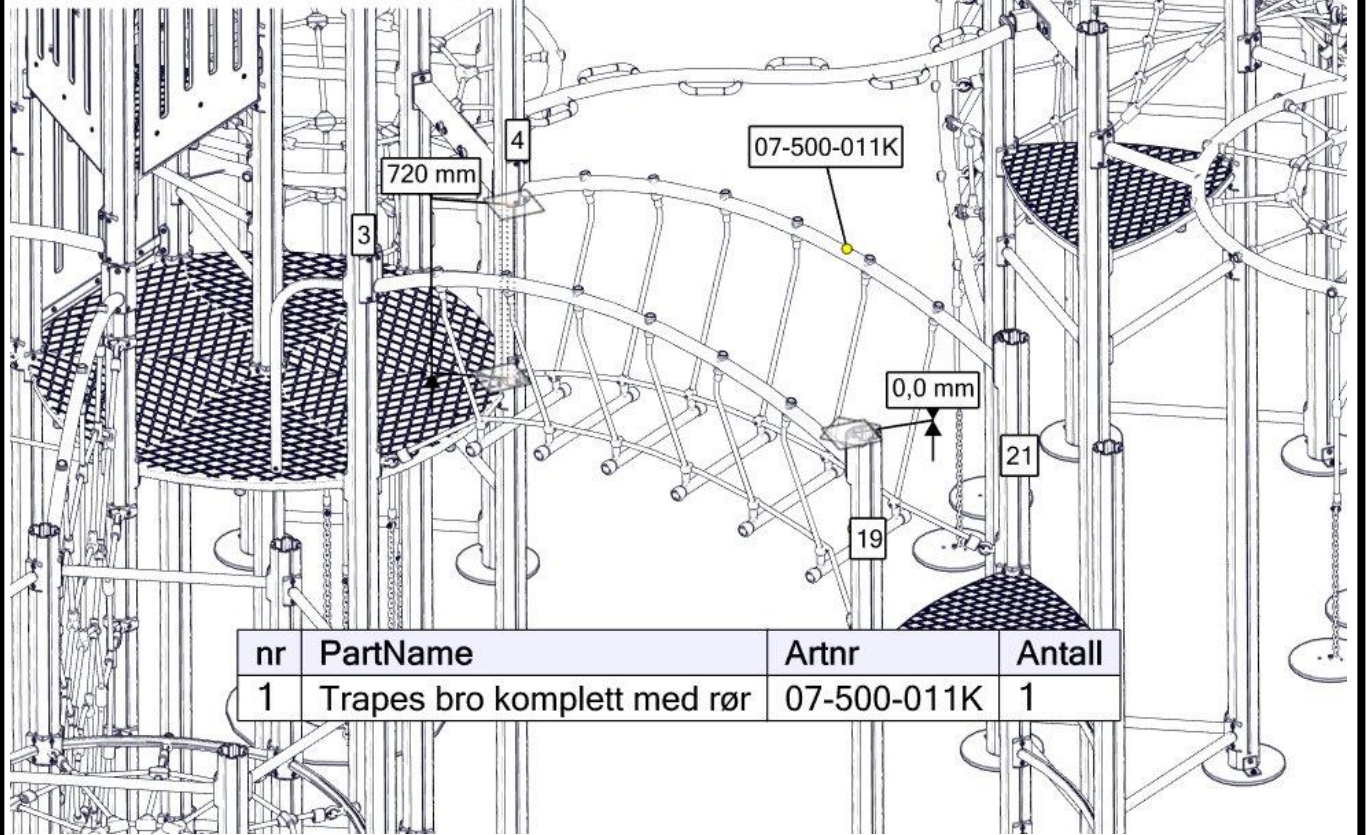

nr	PartName	Artnr	Antall
1	Trapes bro komplett med rør	07-500-011K	1

Se separat delmontering for detaljer  
 See separate assembly for details  
 Se separata delmontering för detaljer

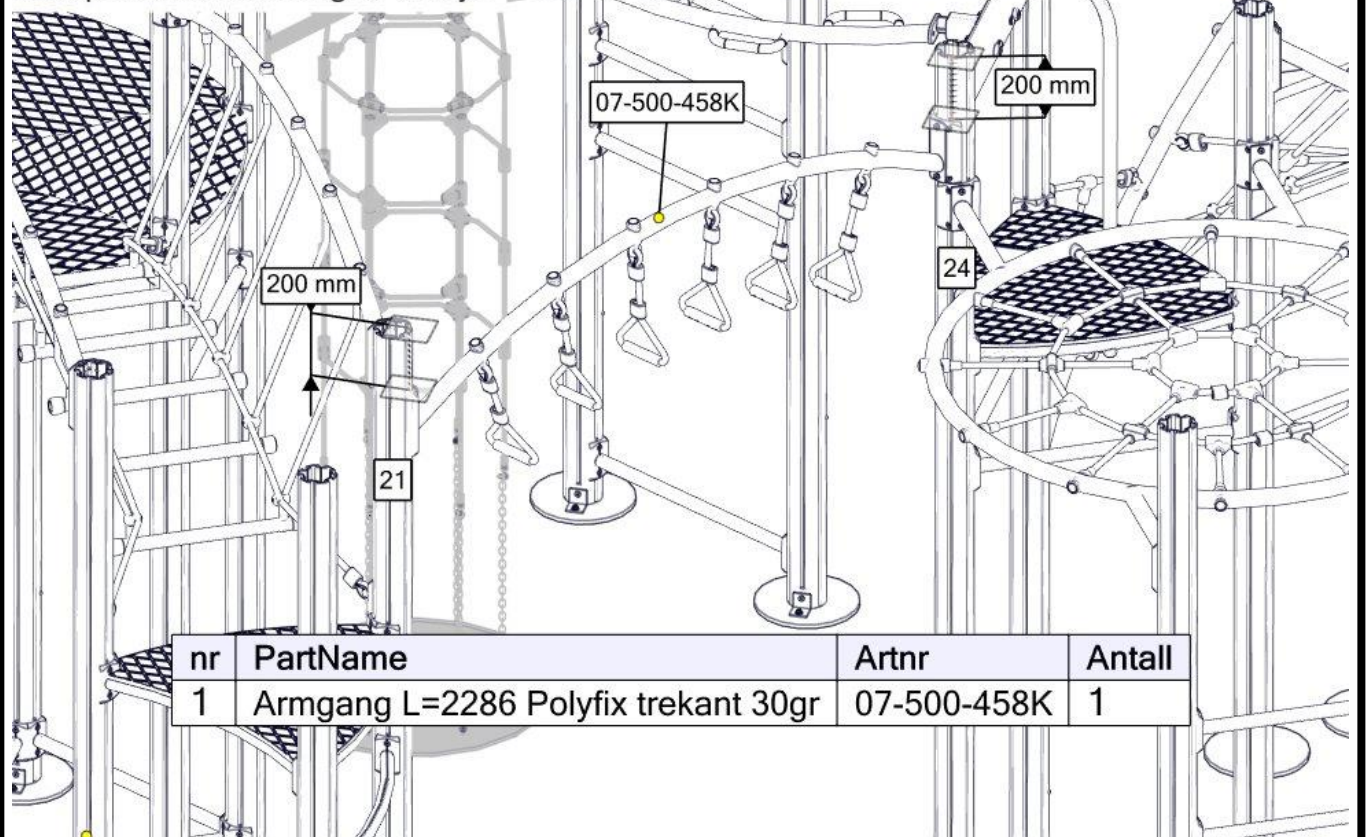

nr	PartName	Artnr	Antall
1	Armgang L=2286 Polyfix trekant 30gr	07-500-458K	1



Se separat delmontering for detaljer  
 See separate assembly for details  
 Se separata delmontering för detaljer

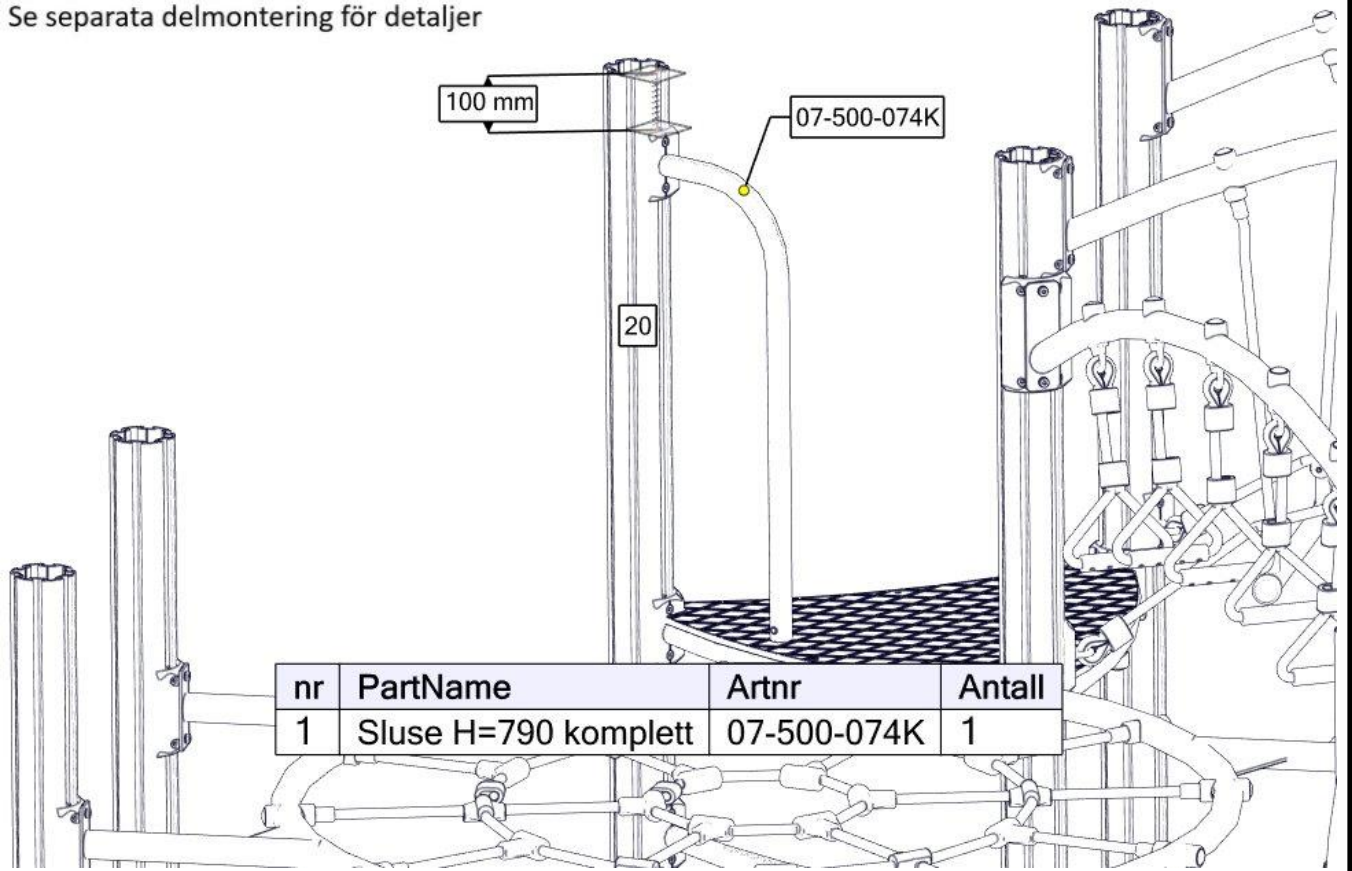

nr	PartName	Artnr	Antall
1	Sluse H=790 komplett	07-500-074K	1

Se separat delmontering for detaljer  
 See separate assembly for details  
 Se separata delmontering för detaljer

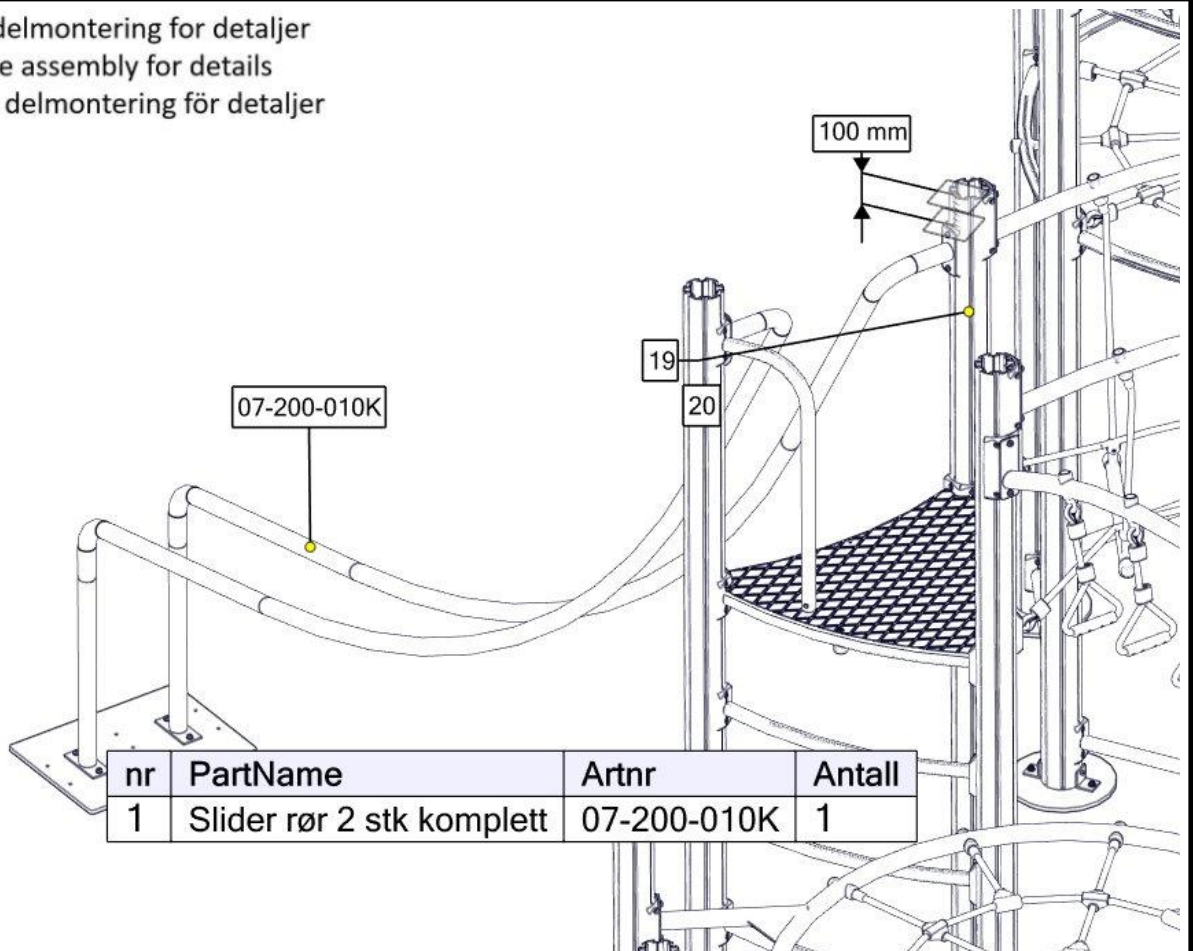

nr	PartName	Artnr	Antall
1	Slider rør 2 stk komplett	07-200-010K	1



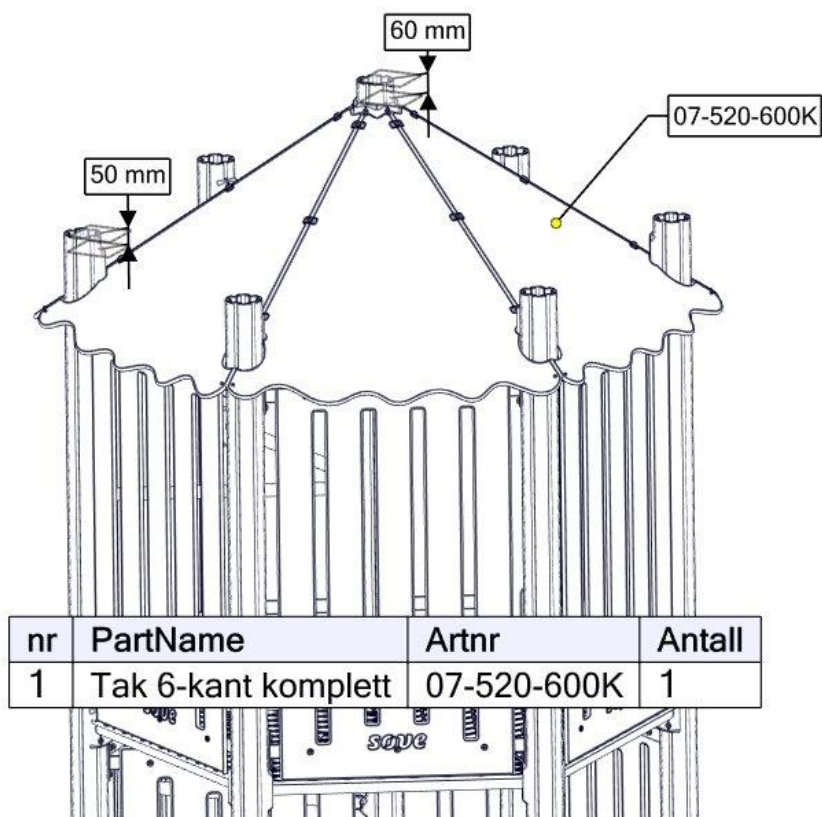

Se separat delmontering for detaljer  
 See separate assembly for details  
 Se separata delmontering för detaljer

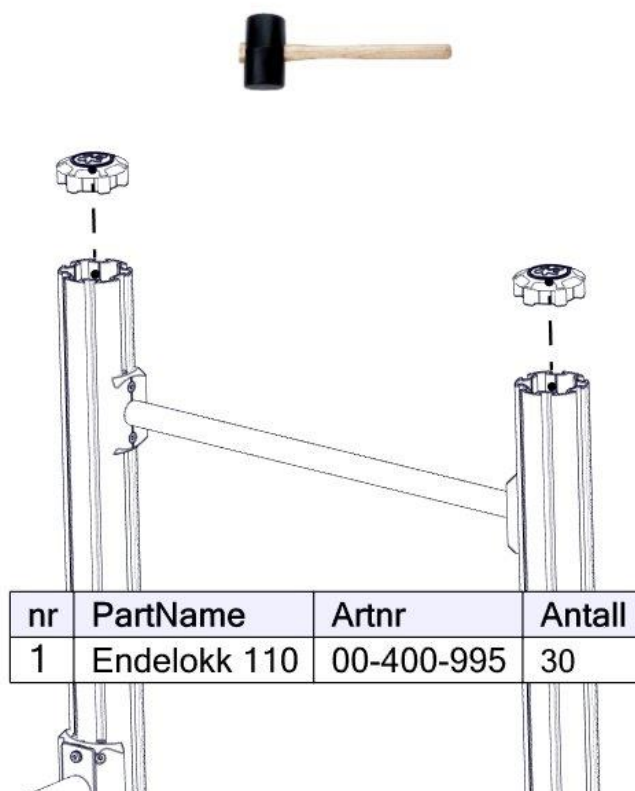

Se separat delmontering for detaljer  
 See separate assembly for details  
 Se separata delmontering för detaljer

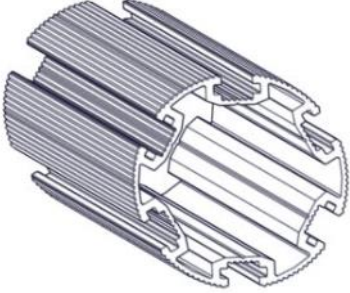

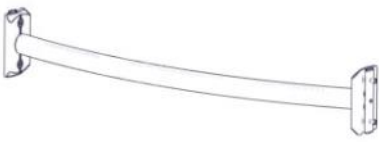





<b>Før utstyret tas i bruk / Before play begins / Innan lekredskapet tas i bruk</b>	
<b>N</b>	<ul style="list-style-type: none"> <li>● Påse at fallunderlag er utlagt i henhold til gjeldende regler eller vår anbefaling</li> <li>● Fjern alle monteringshjelpemidler ( rester av betong, planker, paller, plast, og lignende)</li> <li>● Før utstyret tas i bruk, burde man sjekke at det ikke er fare for at anorakksnorer og lignende som kan hekte seg fast noen steder på lekeapparatet. (Vedlagte snor med dobbe (kneledd) kan brukes til å sjekke at dette er i orden. Se vedlagte veiledning for bruk av denne. Dette gjøres for å oppdage eventuelle feilmonteringer.?</li> <li>● NB! Bør stå i 2-3 dager før bruk</li> </ul>
<b>EN</b>	<ul style="list-style-type: none"> <li>● Make sure the area and depth of safer surfacing are according to the current standard, or to the manufacturer's recommendation</li> <li>● Make sure all tools and surplus materials are removed before play begins</li> <li>● PS! When complete, allow 2-3 days for the concrete to set before use</li> </ul>
<b>S</b>	<ul style="list-style-type: none"> <li>● Kontrollera att fallunderlag är utlagt enligt gällande regler eller vårt rekommendation</li> <li>● Ta bort alla monteringshjälpmedel (rester av betong, plankor, pallar, plast och liknande)</li> <li>● Innan lekredskapet används, kontrollera att anoracksnoddar eller kläder/delar av kläder eller liknande inte kan fastna i några delar på redskapet. (Den bipackade "knävringen" kan man med fördel användas för denna kontroll.</li> <li>● Detta görs för att upptäcka eventuella felmonteringar.)</li> </ul>

<b>Boltepakker for / Boltpackage for / Bultpaket för</b>		Sign. _____.		
<b>Thorium Monazitt 14-200-040</b>	<b>Navn</b>	<b>Artnr/dimensjon</b>	<b>Ant</b>	<b>Lev</b>
	Stolpe Ø110 L=3650 Grå	SFA5126/2	2	
	Stolpe Ø110 L=3450 Grå	SFA5126/2	21	
	Endelokk til stolpe Ø110	00-400-995	30	
	Thorium Tårn-del 1	14-200-Tårn1 (se egen del- montering)	1	
	Thorium Tårn del 2	14-200-Tårn2 (se egen del- montering)	1	
	Sperrerør bøyd uten hull L=750 Grønn	07-500-072K (se egen del- montering)	4	
	Sperrerør rett uten hull L=750 Sort	07-500-075K (se egen del- montering)	19	
	Sperrerør rett L=750 Uten hull Grønn	07-500-059K (se egen del- montering)	23	

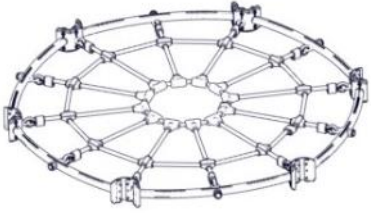





**Boltepakker for / Boltpackage for / Bultpaket för**

Sign. \_\_\_\_\_

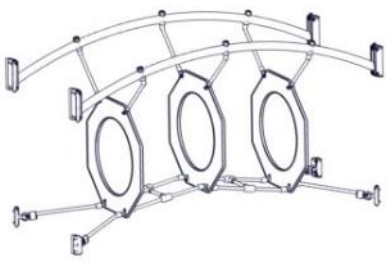

Thorium Monazitt 14-200-040	Navn	Artnr/dimensjon	Ant	Lev
	Edderkoppnett horisontalt CC880 Grønn	07-500-210K (se egen del- montering)	2	
	Edderkoppnett 30gr L=2200 Grønn	07-500-032K (se egen del- montering)	1	
	Sluse H=790 Grønn	07-500-074K (se egen del- montering)	4	
	Bro tordert nett Med 2 x stige lang	07-500-305K (se egen del- montering)	1	
	Gulv 3-kant standard CC880 Grå	07-300-104K (se egen del- montering)	2	
	Gulv 3-kant 1konkav 880 x 880 Grå	07-300-105K (se egen del- montering)	1	

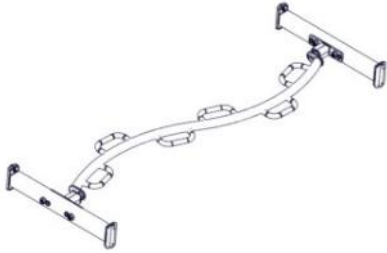
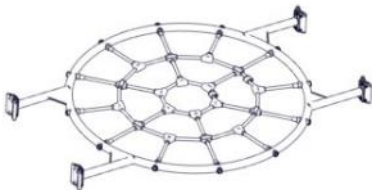

<b>Boltepakker for / Boltpackage for / Bultpaket för</b>		Sign. _____.		
<b>Thorium Monazitt 14-200-040</b>	Navn	Artnr/dimensjon	Ant	Lev
	Bro HPL plate komplett Grønn	07-500-436K (se egen del- montering)	1	
	Dobbel monkeyseats bro Grønn	07-500-425K (se egen del- montering)	1	
	Brannstang Gulv = 1,95m Grå	07-200-037K (se egen del- montering)	1	
	Bro rundgang med sjakt CC880 L=2200 Grønn	07-200-260K (se egen del- montering)	1	
	Bevegelig armgang Grønn	07-500-281K (se egen del- montering)	1	
	Bro rundgang CC880 L=2200 Grønn	07-200-261K (se egen del- montering)	1	

**Boltepakker for / Boltpackage for / Bultpaket för**

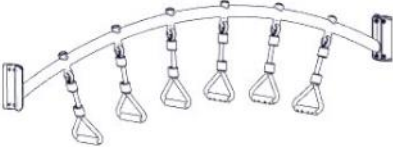
Sign. \_\_\_\_\_.

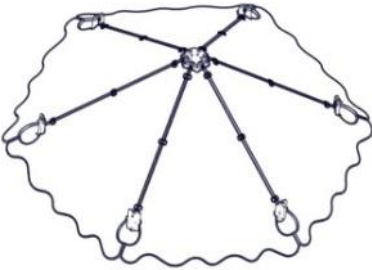
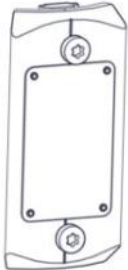
Thorium Monazitt 14-200-040	Navn	Artnr/dimensjon	Ant	Lev
	Trapes bro CC880 Grønn	07-500-011K (se egen del- montering)	1	
	Armgang med polyfix trekant håndtak 30gr beslag Grønn	07-500-458K (se egen del- montering)	1	
	Slider rør	07-200-010K (se egen del- montering)	1	
	Tak 6-kant Grå	07-520-600K (se egen del- montering)	1	
	Produktmerke	07-500-500 (se egen del- montering)	1	

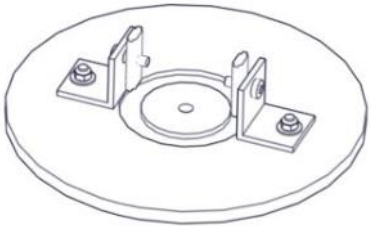
<b>Boltepakker for / Boltpackage for / Bultpaket för</b>		Sign. _____.		
<b>Thorium Monazitt 14-200-040</b>	<b>Navn</b>	<b>Artnr/ dimensjon</b>	<b>Ant</b>	<b>Lev</b>
	<b>Fundament Støp</b>			
	Støpefundament Dimensjon 110	00-003-111K (se egen del- montering)	23	
	<b>Fundament Nedgravning</b>			
	Fundamentplate Stolpe Komplett 1 x 110	07-400-101K (Se egen del- montering)	23	