

N

Monteringsanvisning

EN

Assembly Instructions

S

Monteringsanvisning

Produkt nr. / Product no. / Produkt nr.

14-200-020

Ord. nr. _____

Dato. _____

Sign. _____

**sove**

Søve AS
3830 Ulefoss - Norway
Tlf: +47 35 94 65 65
www.sove.no



Søve AB
EA Rosengrensgratan 32
421 31 Västra Frölunda
Phone: +46 (0)31 773 97 00
www.sove.se

Monteringstips / Assembly Advice / Monteringsstips

N

- Les monteringsanvisningen nøye før montering.
- Monter elementene i rekkefølgen som vist.
- Boltene bør ikke skrues for hardt til før alt er montert, vatret og loddet. Skru så boltene til.
- NB! Ved bruk av drill, kan boltene ryke.
- På grunn av at solen kan gjøre rutsjeflaten veldig varm, bør rutsjebanens utløp vende mot nord-øst eller nord-vest.
- Er lekeutstyret plassert i naturlige ferdselstraséer må området sikres mot gjennomgang.
- Innspringningshinder bør vurderes rundt lekeapparater hvor det er stor bevegelse, f.eks. ved huskestativ.
- Det bør være fritt innsyn til lekeutstyr som er beregnet for barn under 3 år.

NB! Under monteringsarbeidet må utstyr, som ikke er forankret forsvarlig i bakken, sikres slik at det ikke velte.

Området må avstenges under montering av apparatene med sperrebånd eller lignende.

EN

- Read the instruction carefully before assembling the play unit..
- Assemble the components in the sequence shown in these instructions.
- Fixings must not be fully tightened during assembly. Before casting the foundations, the structure must be level and plumb, at which point all fixings are tightened.
- PSI If use of drill, the bolts may be wrecked.
- Avoid positioning the slide facing due south because of overheating – ideal positions are facing north-east or north-west.
- Secure the construction-area to prevent people from walking through it.
- Consider installing barriers around play-equipment which gives rise to a lot of activity – i.e.swings.
- Ensure that clear vision is possible across the play area so that supervision is possible from any position, particularly where children under 3 years of age will be playing.

NB! During assembly of the equipment, ensure that all structures are securely propped, especially when left overnight. Also ensure that equipment is supported whilst concrete foundations are setting and enclose the area securely to prevent access.

Monteringstips / Assembly Advice / Monteringsstips

S

- Läs monteringsanvisningen noga före montering.
- Montera delarna i den ordningen som anvisas
- Skruvarna bör inte skruvas för hårt tills allt är monterat, i våg och lodat.









OBS! Används elektrisk skruvdragare, kan bulten gå sönder. Hårdra därför manuellt!

- Solen kan göra att rutchbanan blir väldigt varm. Banans nedfart rekommenderas att vändas i norrlig riktning
- Om lekplatsen placeras vid en gångväg mm bör området säkras mot genomfart av gående och cyklister.
- Inspringshinder bör placeras runt lekutrustning med stor rörelse, t ex, gungställning.
- Det bör vara fri insyn till lekutrustning beräknat till barn under 3 år.

OBS! Under monteringsarbete bör utrustningen som inte ska förankras i marken, ställs så att den inte kan välta.

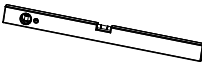
Området måste spärras när lekutrustningen byggs upp, med avspärrningsband eller liknande.

Nødvendig verktøy / Tools required / Nödvändiga verktyg

<p>(N)</p> <p>(EN)</p> <p>(S)</p>	<p>(A)</p> 	<p>(B)</p> <p>Torx Nr 45 High quality</p> 	<p>(C)</p> <p>13 + 17mm</p> 	<p>(D)</p> 	<p>(E)</p> 
		<p>Metermål Metric measure Tumstock</p> 	<p>16 V</p> 	<p>Merkebånd Mark ribbon Märkeband</p> 	<p>5 mm 6 mm</p> 

Nødvendig antall personer / Number of persons required / Rekommenderad antal personer





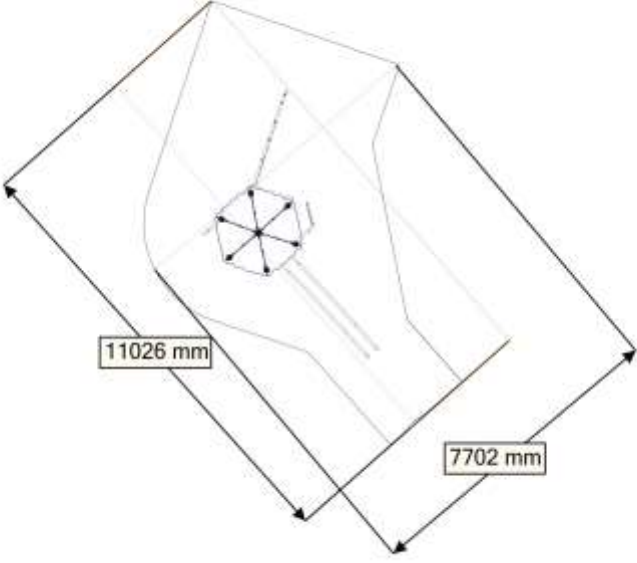

<p>(N)</p> <p>(EN)</p> <p>(S)</p>	
-----------------------------------	---

Anbefalt arealbehov ved montering / Recommended working space / Rekommenderad arealbehov vid montering

<p>(N)</p> <p>(EN)</p> <p>(S)</p>	
-----------------------------------	--

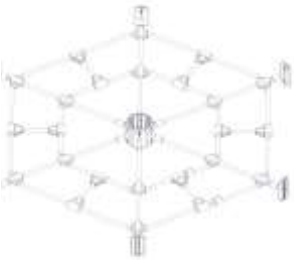
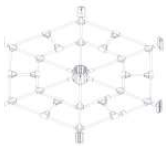
Boltepakker for / Boltpackage for / Bultpaket för

Sign. _____

Stolpe 6SP_110		Navn	Artnr/dimensjon	Ant	Lev
		Stolpe L=4000 (600-3400)	07-100-334	6	
		Stolpe L=4500 (600-3900)		1	
Stolpe end		Navn	Artnr/dimensjon	Ant	Lev
		Stopl end	04-400-995	7	
6-kant rund nett For Stolpe	Ant=1	Navn	Artnr/dimensjon	Ant	Lev
		6-kant rund nett FOR STOLPER. Inkl 12x 0g 120mm beslag	07-500-211	1	
		12x 120mm 0 gr beslag på stolpe	07-150-120	0	
		Brikke 50_1T(12)	04-060-120	12	
		TorxM8x25 (24)	04-000-025	24	
		Umbrako M10x25 (12)	04-037-025	0	













Boltepakker for / Boltpackage for / Bultpaket för

Sign. _____

Sluse: 07-500-062	Ant= 3	Navn	Artnr/dimensjon	Ant	Lev
		Sluse (1)	07-150-064	3	
		Brikke 120_2T (1)	04-060-120	3	
		Torx M8x25 (2)	04-000-025	6	
		Torx M8x45 (1)	04-000-045	3	
		Skive M8 Stor (1)	04-055-008	3	
	Hullsemutter (1)	04-018-060	3		
Sperrerør_ : 07-500-061 Med hull gulv	Ant= 6	Navn	Artnr/dimensjon	Ant	Lev
		Sperrerør_gulv (1)	07-150-061	6	
		Brikke 120_2T (2) 6 st på stolpe	04-060-120	0	
		Torx M8x25 (4)	04-000-025	24	
Sperrerør_ : 07-500-060	Ant= 8	Navn	Artnr/dimensjon	Ant	Lev
		Sperrerør_(1)	07-150-060	8	
		Brikke 120_2T (2)	04-060-120	16	
		Torx M8x25 (4)	04-000-025	32	







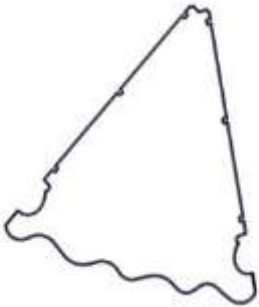

Boltepakker for / Boltpackage for / Bultpaket för

Sign. _____

Gulv 07-301-121 6kant for slider	Ant= 1	Navn	Artnr/dimensjon	Ant	Lev
		gulv (1)	07-301-121	1	
		Möbelknapp (3)	04-030-011 M8_13_17	3	
		Torx M8x45 (3)	04-000-045	3	
Gulv 07-301-120 6kant std	Ant= 5	Navn	Artnr/dimensjon	Ant	Lev
		gulv (1)	07-301-120	5	
		Möbelknapp (3)	04-030-011 M8_13_17	15	
		Torx M8x45 (3)	04-000-045	15	
		Plast plugg (2) 9-11mm	04-090-002	10	
Sperrerør_ : 07-500-064	Ant= 6	Navn	Artnr/dimensjon	Ant	Lev
		Sperrerør_(1)	07-150-064	6	
		Brikke 120_2T (2) På stolpe	04-060-120	0	
		Torx M8x25 (4)	04-000-025	24	



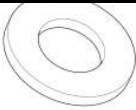











Boltepakker for / Boltpackage for / Bultpaket för

Sign. _____

6kant tak 07-500-600	Ant= 6	Navn	Artnr/dimensjon	Ant	Lev
		6kant tak (1)	07-500-600	6	
		Sperrerør 6kant tak	07-150-064	6	
		Fest U 6-kant tak	07-520-611	18	
		Møbelknapp (3) 16x11	04-030-011	18	
		Torx M8x45 (3)	04-000-045	18	
		Sekskant M8x35 Rustfritt	04-058-008	24	
		Skive rustfritt M8	04-058-008	24	
		Brikke 150 2xM8	04-060-151	12	









Boltepakker for / Boltpackage for / Bultpaket för





Sign. _____.



Fundament 07-400-103 3stolpe	Ant= 1	Navn	Artnr/dimensjon	Ant	Lev
		3Kant fun plate (1)	07-400-003	1	
		Vinkel 50x50x50(6)	04-070-050	6	
		Brikke 50_1T(6)	04-060-050	6	
		Torx M8x30 (6) Torx M8x25(6)	04-000-030 04-000-025	6 6	
		Skive M8 (12)	04-055-008	12	
		Låsemutter M8(6)	04-040-008	6	
Fundament 07-400-102 2stolpe	Ant= 2	Navn	Artnr/dimensjon	Ant	Lev
		Dobbel fun plate (1)	07-400-002	2	
		Vinkel 50x50x50(4)	04-070-050	8	
		Brikke 50_1T(4)	04-060-050	8	
		Torx M8x30 (4) Torx M8x25(4)	04-000-030 04-000-025	8 8	
		Skive M8 (8)	04-055-008	16	
		Låsemutter M8	04-040-008	8	

Boltepakker for / Boltpackage for / Bultpaket för

Sign. _____



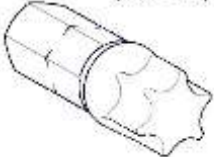



Slider: 07-500-202	Ant=1	Navn	Artnr/dimensjon	Ant	Lev
		Slider	07-200-021	1	
		Ogr 150_2H (2)	07-150-022	2	
		Brikke 150_2T(2)	04-060-151	2	
		TorxM8x35 (8)	04-000-035	8	
		HPL platte Slider	07-200-022	1	
		Skive M8	04-050-008	4	
		M8 mutter	04-040-008	4	

Produktmerke	Ant= 1	Navn	Artnr/dimensjon	Ant	Lev
		Ogr 150_2H (2) Med Produktmerke	????	1	
		Brikke 150_2T(2)	04-060-151	1	
		Torx M8x35 (2)	04-000-035	2	

Bit Torx TX45 (Drive 1/4")	Ant= 1	Navn	Artnr/dimensjon	Ant	Lev
 <p>Torx TX45 (drive 1/4")</p>		Bit Torx TX45	04-001-045	1	









Boltepakker for / Boltpackage for / Bultpaket för











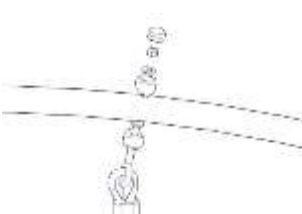
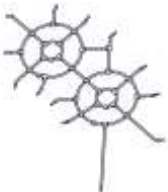

Sign. _____

S-treppa 07-500-028	Ant=1	Navne	Artnr/dimensjon	Ant	Lev
		S-treppa	07-200-028	1	
		0gr 120_2H2V (1)	07-150-020	1	
		Brikke 120_3T(1)	04-060-120	1	
		TorxM8x35 (2+2)	04-000-035	4	
		Skive M8 (2)	04-050-008	2	
		Mutter M8 (2)	04-040-008	2	
		Fundamentplatte (1) 2 hull	00-003-009	1	

Boltepakker for / Boltpackage for / Bultpaket för

Sign. _____

Brannstang:07-500-037	Ant=1	Navn	Artnr/dimensjon	Ant	Lev
		Brannstang (1)	07-200-037	1	
		0gr 120_2H2V (1)	07-150-020	1	
		Brikke 120_2T(1)	04-060-120	1	
		TorxM8x35 (4)	04-000-035	4	
		Skive M8 (2)	04-050-008	2	
		Mutte M8 (2)	04-080-008	2	
		Fundamentplatte (1) 2 hull	00-003-009	1	

Boltepakker for / Boltpackage for / Bultpaket för		Sign. _____			
Dobbelt nett 30gr:	Ant=1	Navn	Artnr/dimensjon	Ant	Lev
 		Dobbelt Nett (1)	07-500-018	1	
		Rør stor (1) Rør liten (1)	07-200-015 07-200-016	1 1	
		30gr_150_4H2T(2) 30gr_50_2H1V(2)	07-150-041 07-150-040	2 0	
		Brikke 150_2T(4) Brikke 50_1T(4)	04-060-151 04-060-040	4 4	
		TorxM8x25 (12+4)	04-000-025	16	
		Umbrako M10x25 (2)	04-037-025	0	
		Plasrørdel(20)	05-300-036	20	
		PlastRørdel end(10)	05-300-036	10	
		Skive covered(20)	05-300-036	20	
		M10 mutter (10+1)	04-040-010	11	
		Fundamentplatte(1)	00-003-010	1	
		Skive M10 (1)	04-050-010	1	
		Armering(4)	03-191-013	4	

Fundamentering med betong / Foundation concrete / Förankring med betong

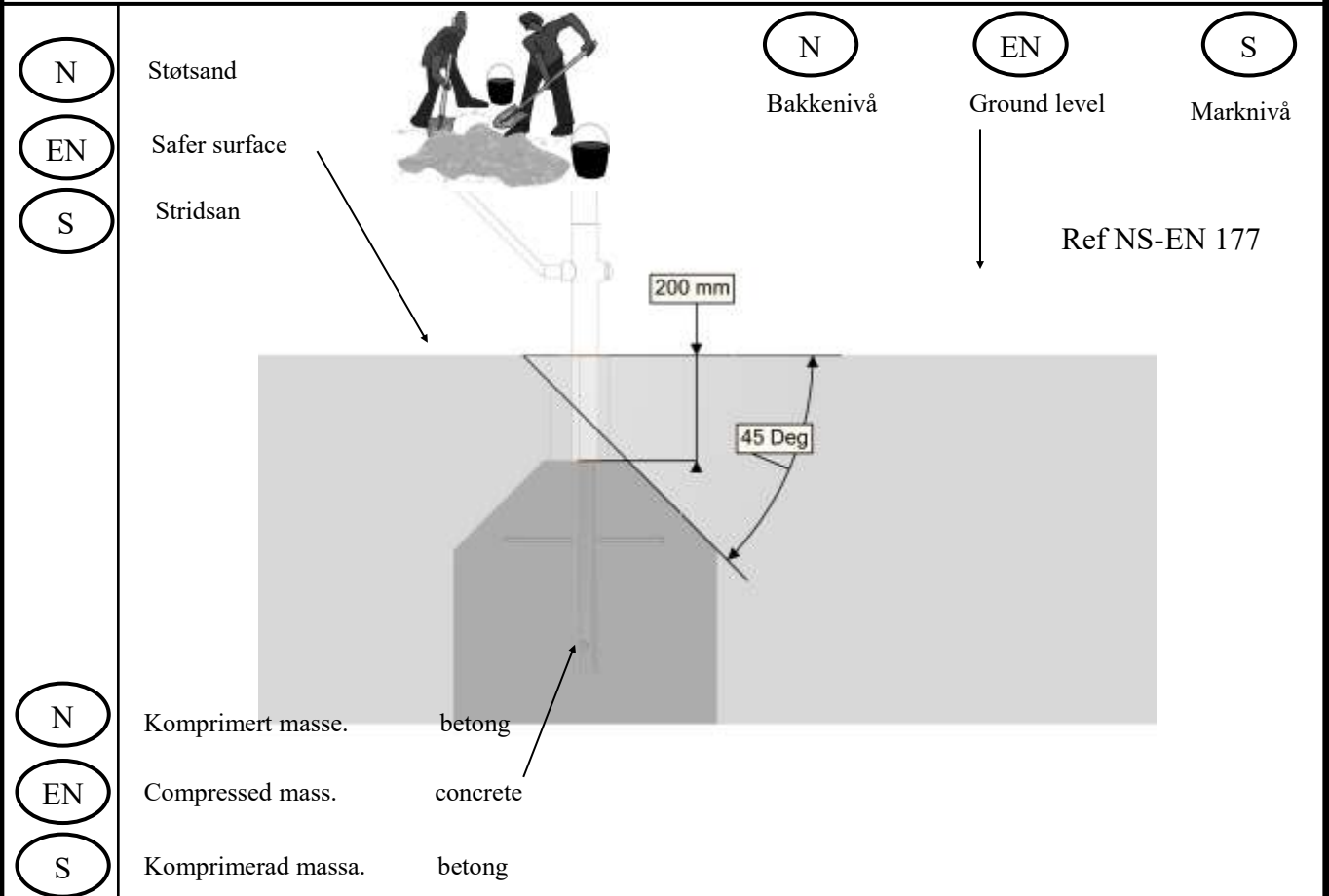

Fundamentering uten betong / Foundation without concrete / Förankring utan betong

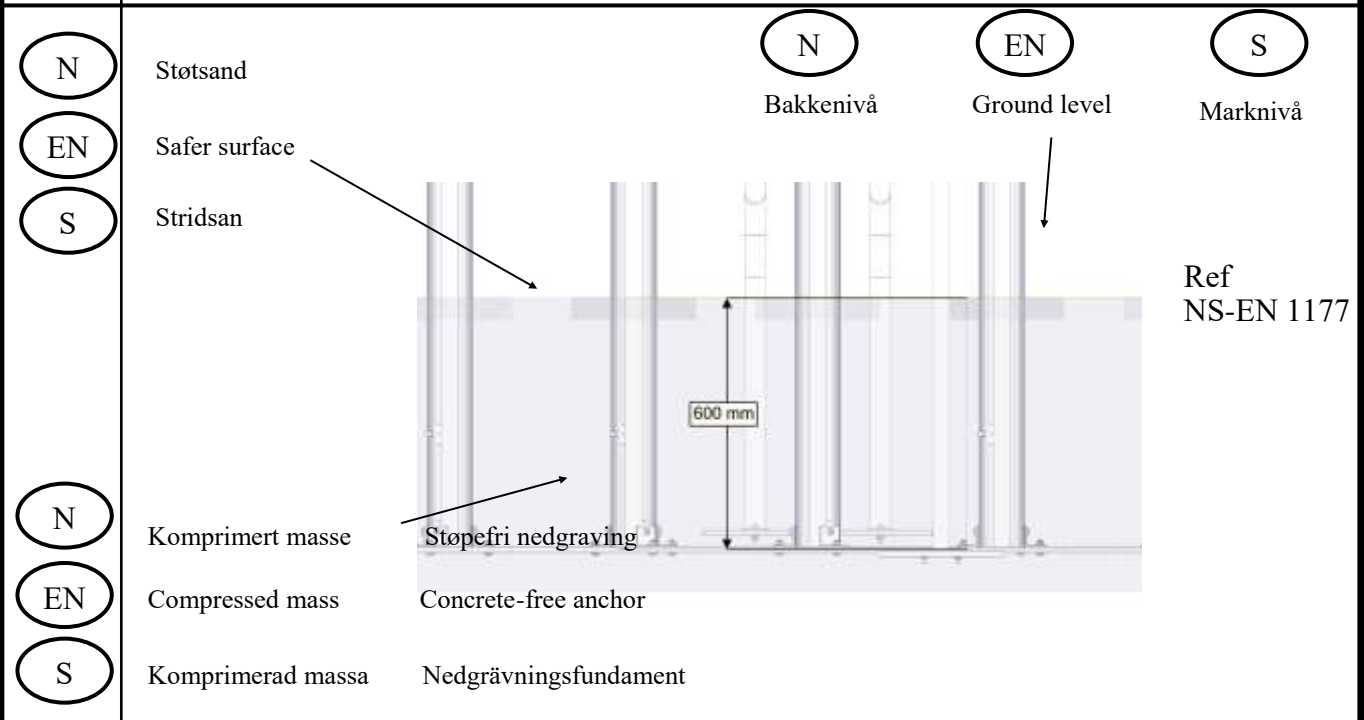

(N)	Alle mål er oppgitt i millimeter
(EN)	Scale measured in mm
(S)	Alla mått är i millimeter.

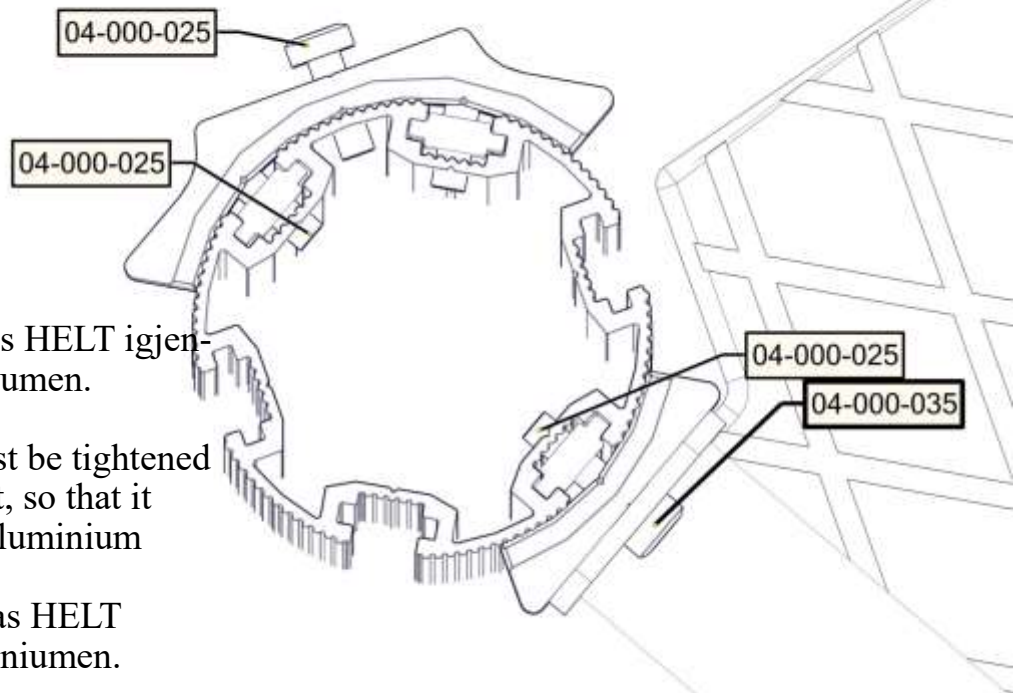

N

Bolten skrues HELT igjennom aluminiumen.

EN

The bolt must be tightened in to the post, so that it pierces the aluminium

S

Bulten skruvas HELT igjennom aluminiumen.

Fallhøyder / Free height of fall / Fallhöjder

Fallhøyde = 2,7 meter

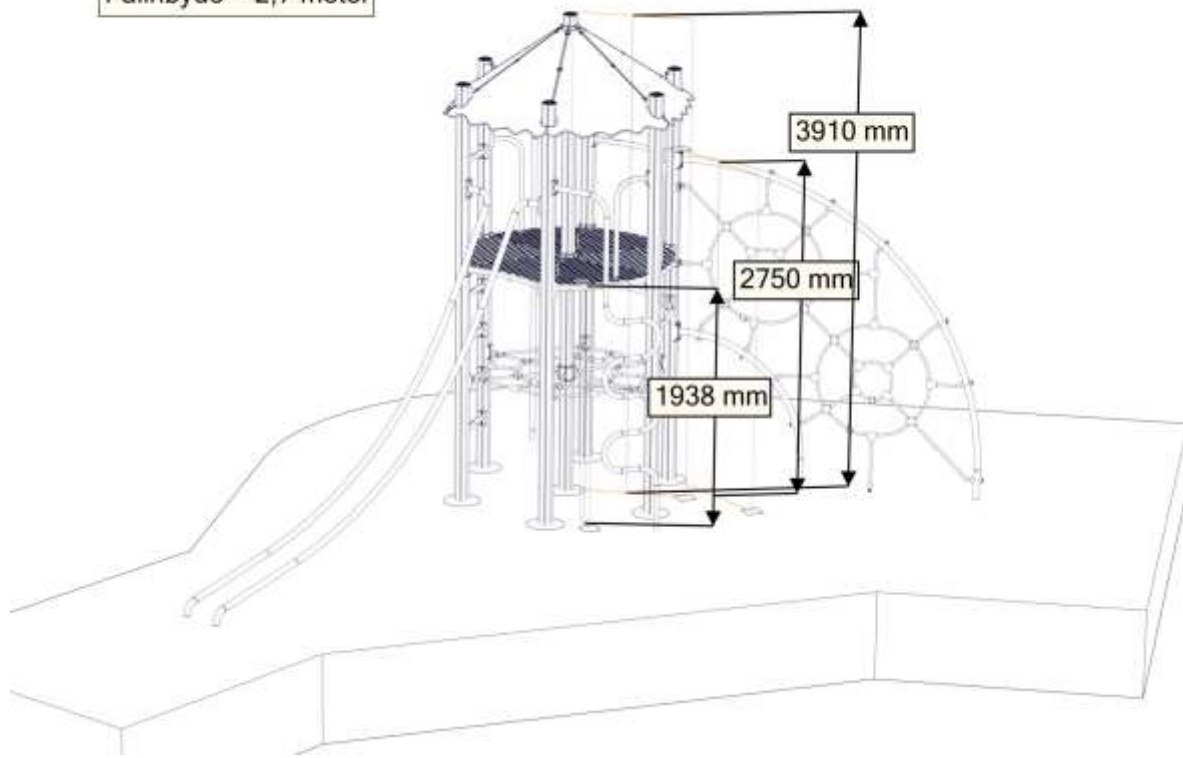

Sikkerhetszone / Safety zone / Säkerhetszon

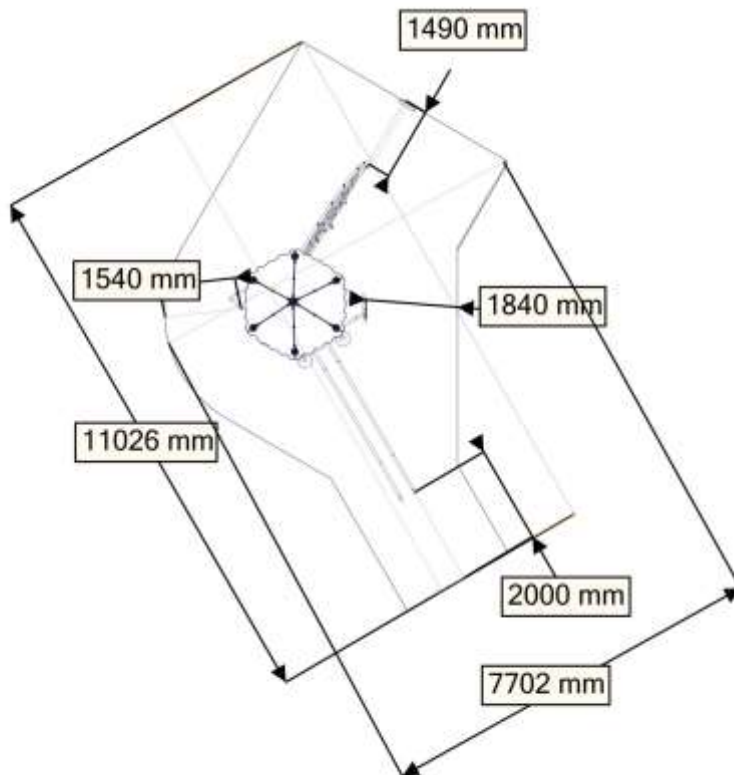

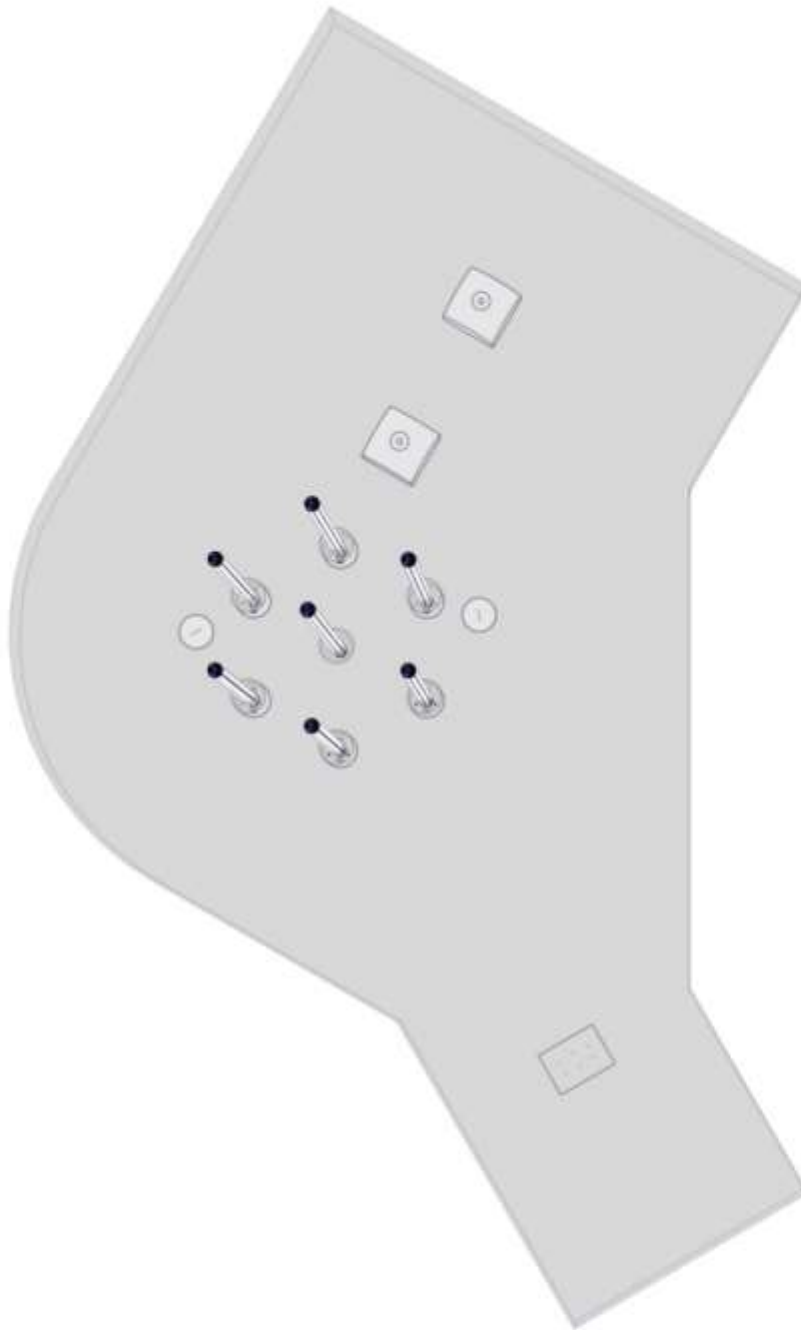
Plassering av forankringer / Ground plan / Placering av förankringar

N

Alle mål er oppgitt i millimeter

EN

Scale measured in mm

S

Alla mått är i millimeter.

Montering av lekeapparatet / Assembly instructions / Montering av lekredskapet

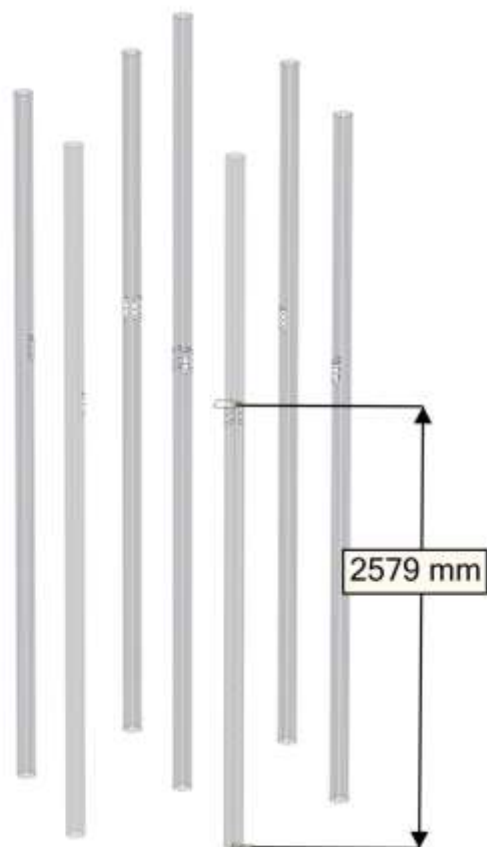

Brikke påmontert hos Søve

2579 mm

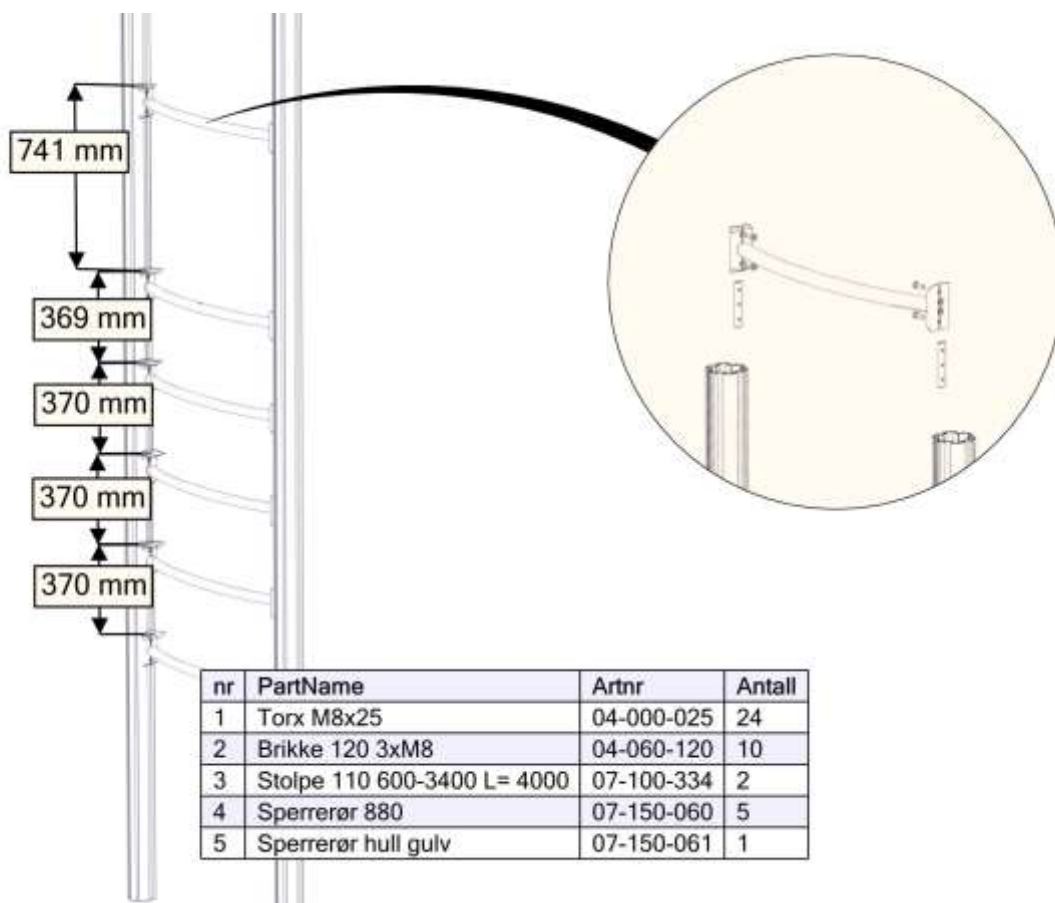

741 mm

369 mm

370 mm

370 mm

370 mm

nr	PartName	Artnr	Antall
1	Torx M8x25	04-000-025	24
2	Brikke 120 3xM8	04-060-120	10
3	Stolpe 110 600-3400 L= 4000	07-100-334	2
4	Sperrerør 880	07-150-060	5
5	Sperrerør hull gulv	07-150-061	1

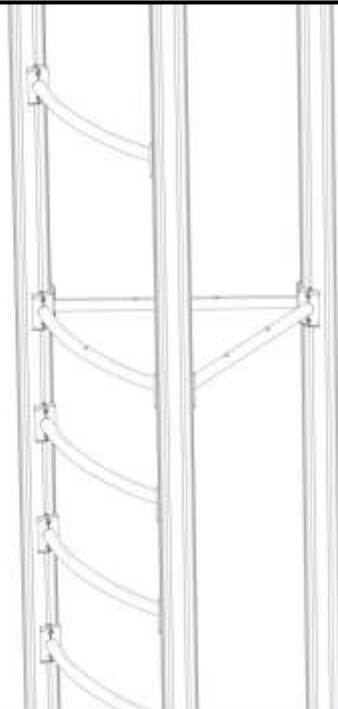

nr	PartName	Artnr	Antall
3	Torx M8x25	04-000-025	8
1	Stolpe110 600-3900 L=4500	07-100-334	1
2	Sperrerør 6kant gulv 2 hull	07-150-064	2

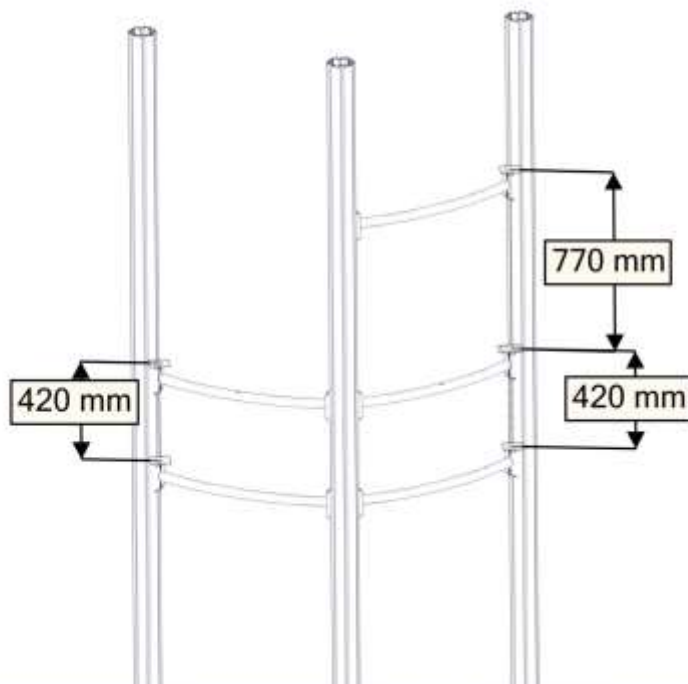

nr	PartName	Artnr	Antall
1	Torx M8x25	04-000-025	20
2	Brikke 120 3xM8	04-060-120	6
3	Sperrerør 880	07-150-060	3

nr	PartName	Artnr	Antall
4	Sperrerør hull gulv	07-150-061	2

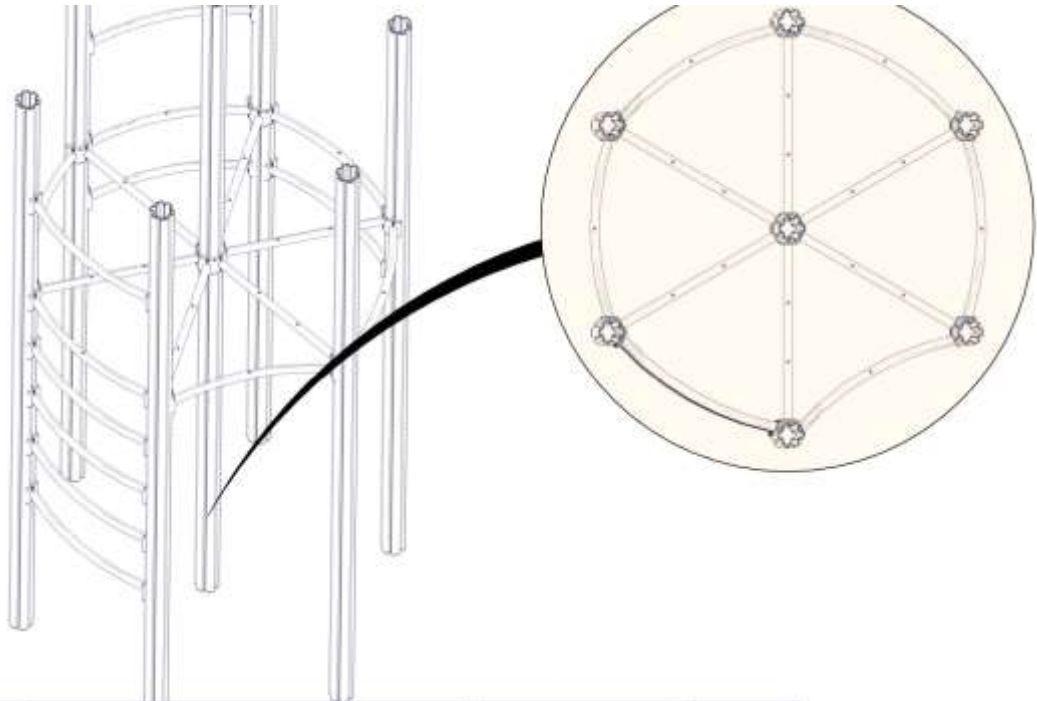

nr	PartName	Artnr	Antall
1	Torx M8x25	04-000-025	28
2	Sperrerør hull gulv	07-150-061	3
3	Sperrerør 6kant gulv 2 hull	07-150-064	4

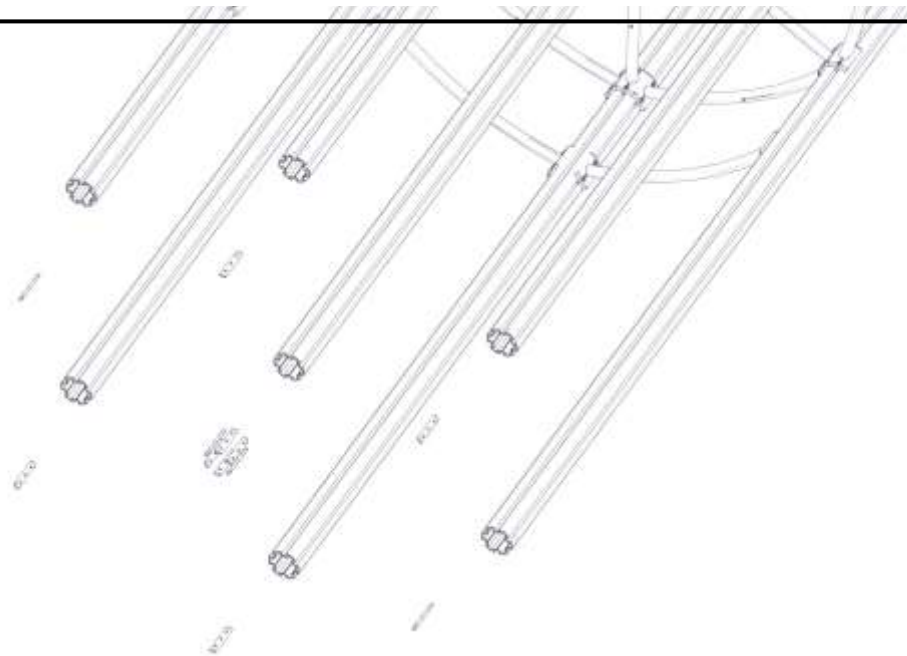

nr	PartName	Artnr	Antall
1	Brikke 120 3xM8	04-060-120	12

04-060-120

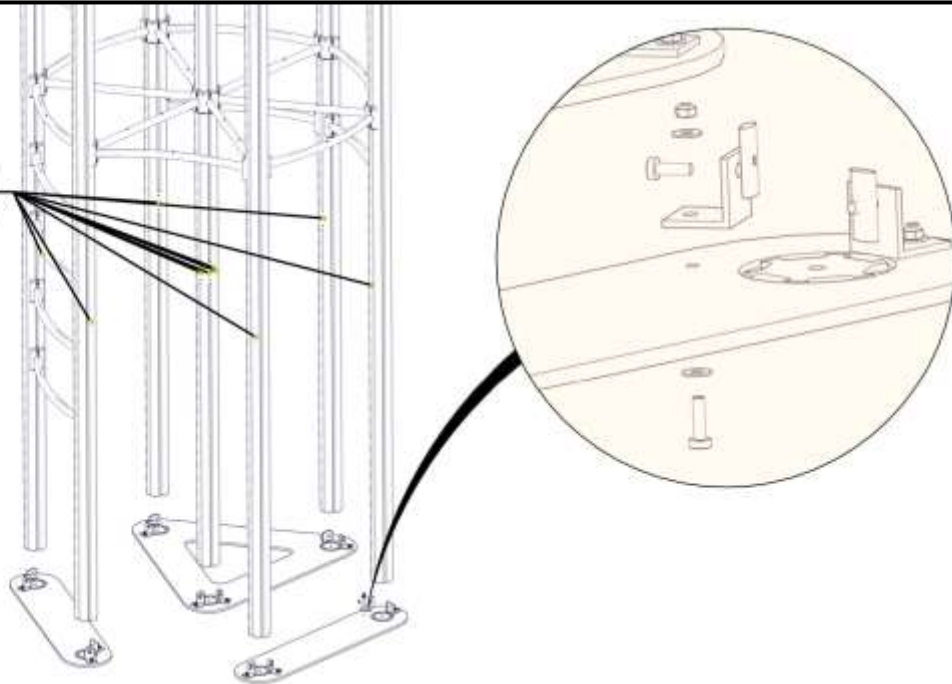

nr	PartName	Artnr	Antall
1	Torx M8x25	04-000-025	14
2	Torx M8x30	04-000-030	14
3	Låsemutter M8	04-040-008	14
4	Skive M8 stor	04-055-008	28
5	Brikke50 1XM8	04-060-050	14

nr	PartName	Artnr	Antall
6	Vinkel 50x50x50x5 11mm hull	04-070-050	14
7	Fundamentplate 2 stolper	07-400-012	2
8	Fundamentplate 3 stolper	07-400-013	1

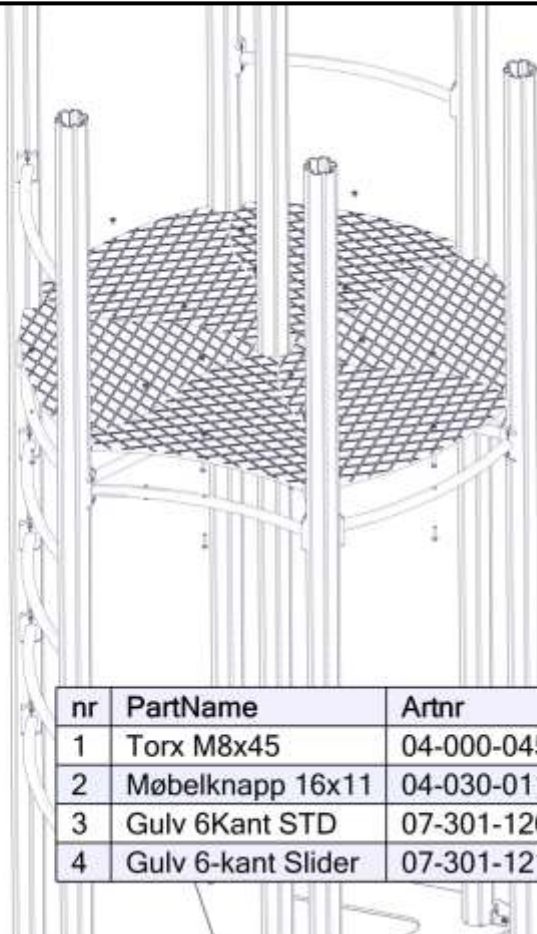

nr	PartName	Artnr	Antall
1	Torx M8x45	04-000-045	18
2	Møbelknapp 16x11	04-030-011	18
3	Gulv 6Kant STD	07-301-120	5
4	Gulv 6-kant Slider	07-301-121	1

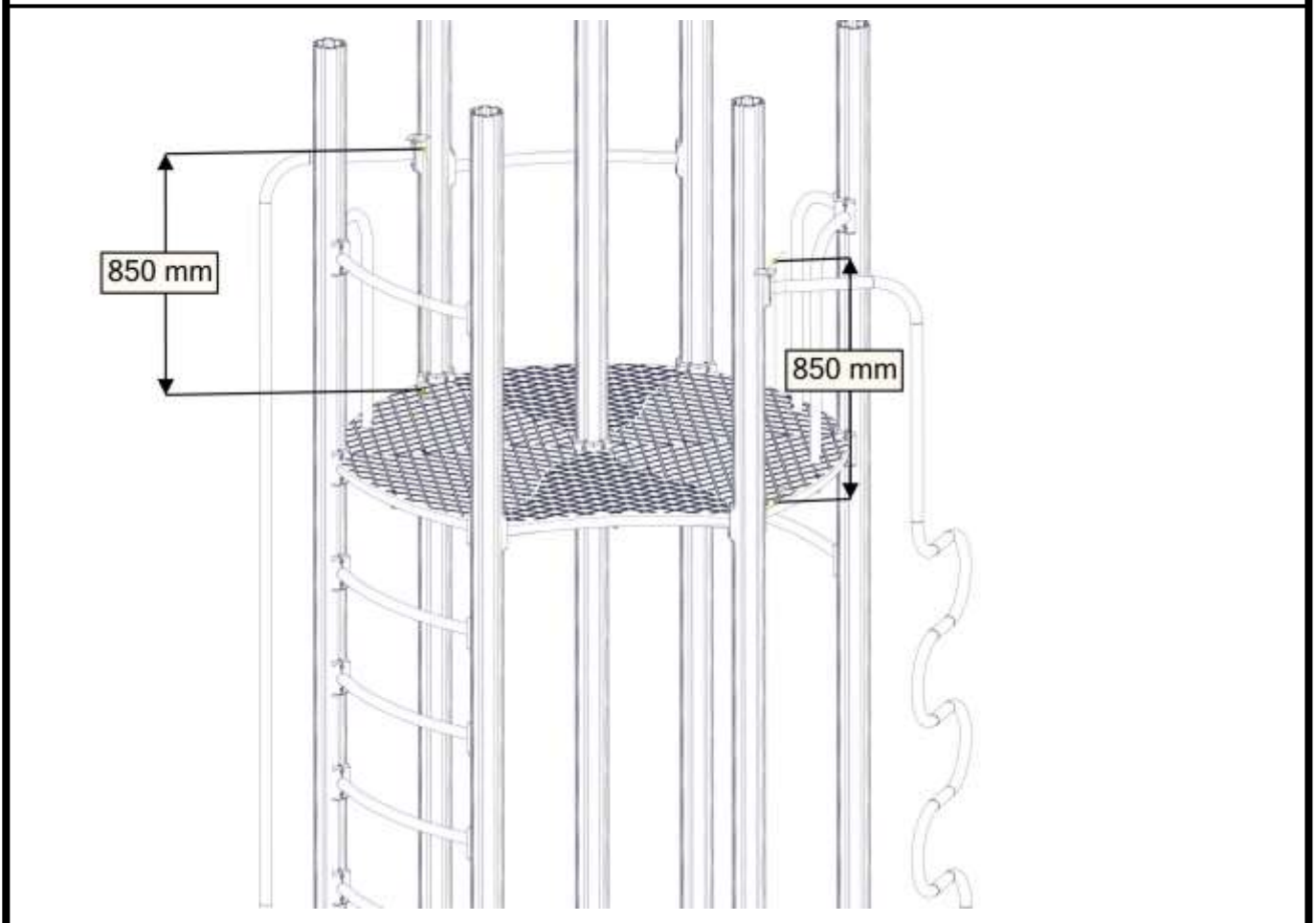
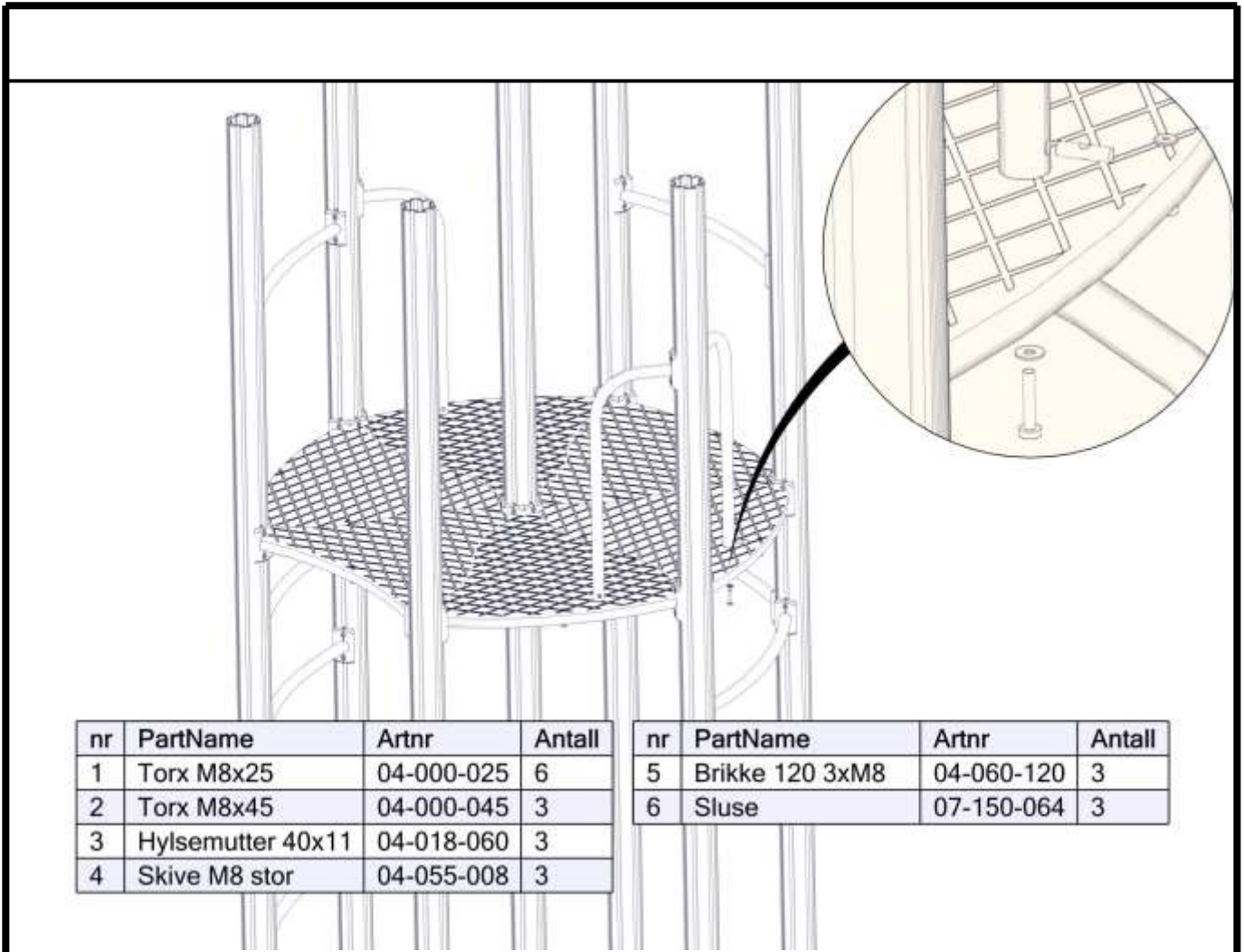

2x

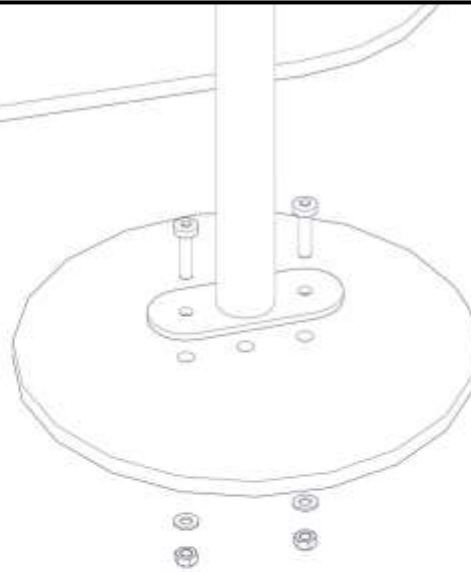

nr	PartName	Artnr	Antall
1	Fundament plate	00-003-106	1
2	Torx M8x35	04-000-035	2
3	Låsemutter M8	04-040-008	2

nr	PartName	Artnr	Antall
4	Skive M8	04-050-008	2

700 mm

nr	PartName	Artnr	Antall
1	Torx M8x35	04-000-035	4
2	Brikke 150 2xM8	04-060-151	2
3	Beslag 0gr 150 2xhull	07-150-022	2
4	Sliderrør venstre og høyre	07-200-021	1

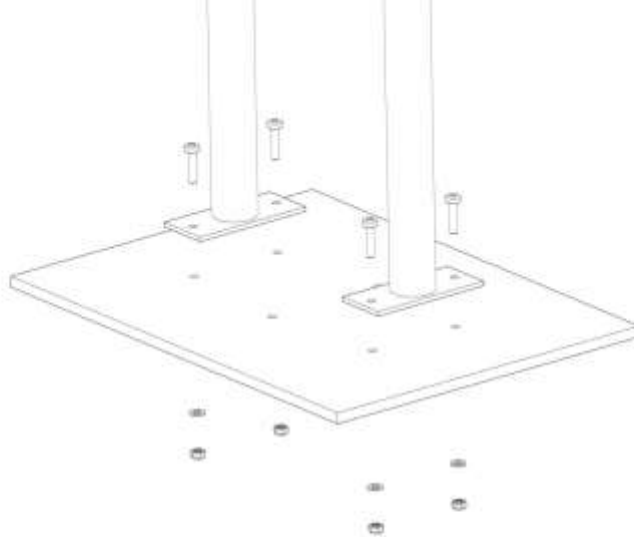

nr	PartName	Artnr	Antall
1	Torx M8x35	04-000-035	4
2	Låsemutter M8	04-040-008	4
3	Skive M8	04-050-008	4
4	Fundamentplate Slider	07-200-022	1

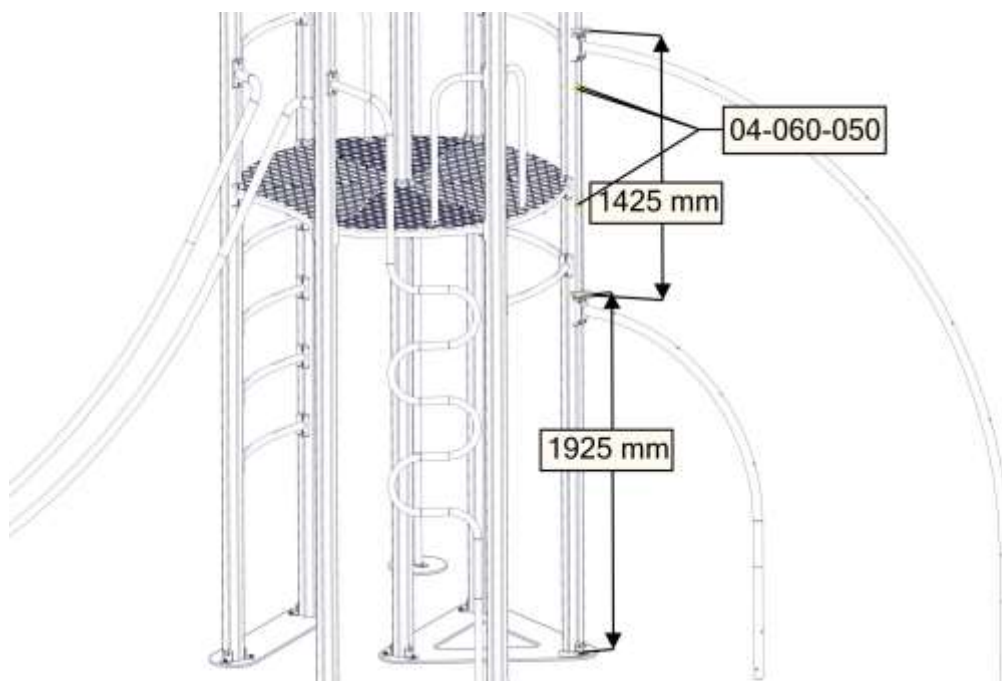

nr	PartName	Artnr	Antall
4	Torx M8x25	04-000-025	12
1	Brikke50 1xM8	04-060-050	4
5	Brikke 150 2xM8	04-060-151	4
6	Beslag 30gr 150 4xhull 2xM8	07-150-041	2

nr	PartName	Artnr	Antall
2	Rør dobbelt nett Stor	07-200-015	1
3	Rør dobbelt nett Liten	07-200-016	1



nr	PartName	Artnr	Antall
1	Armering	03-191-013	4
2	Fundament plate	00-003-103	1
3	Låsemutter M10	04-040-010	1

nr	PartName	Artnr	Antall
4	Skive M10 stor	04-055-010	1

6x

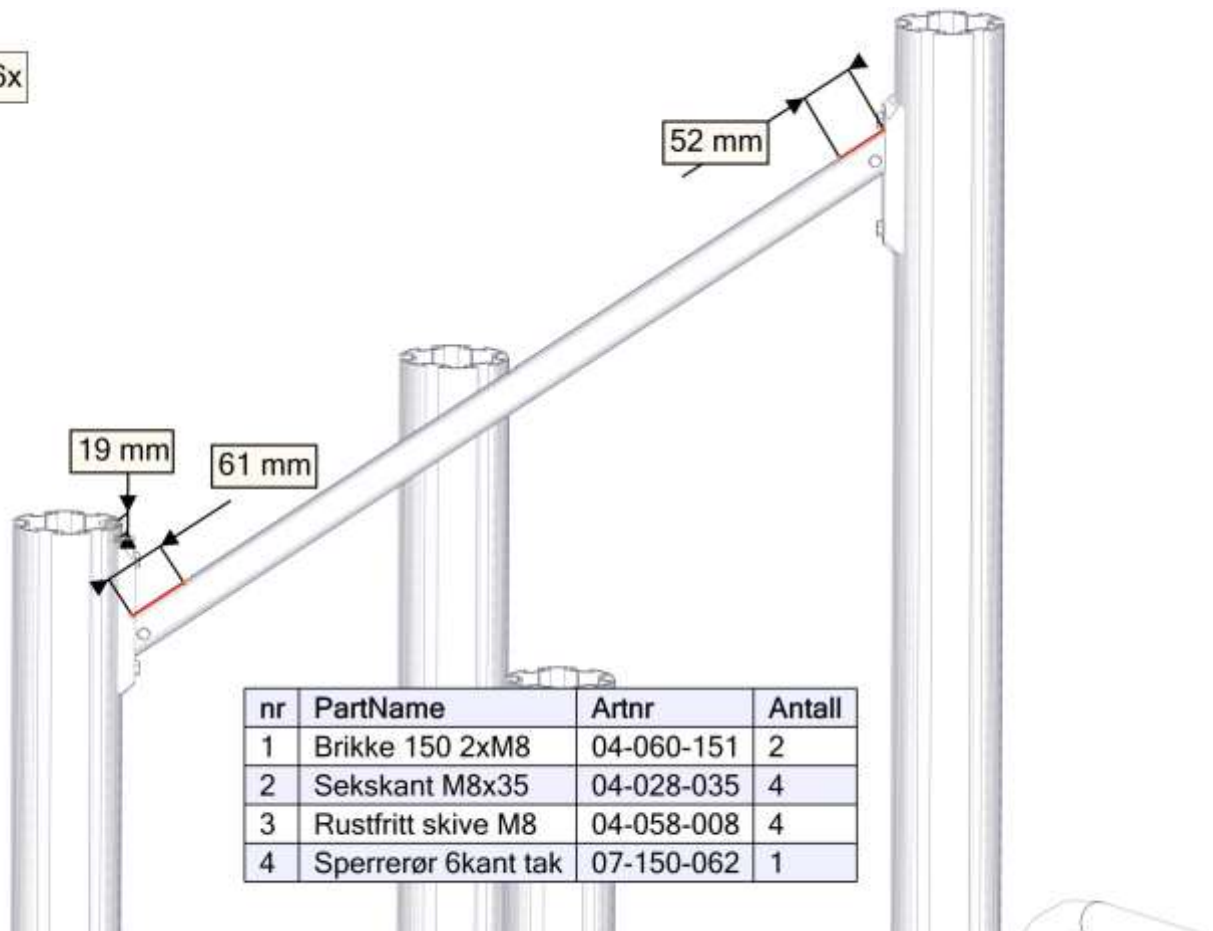



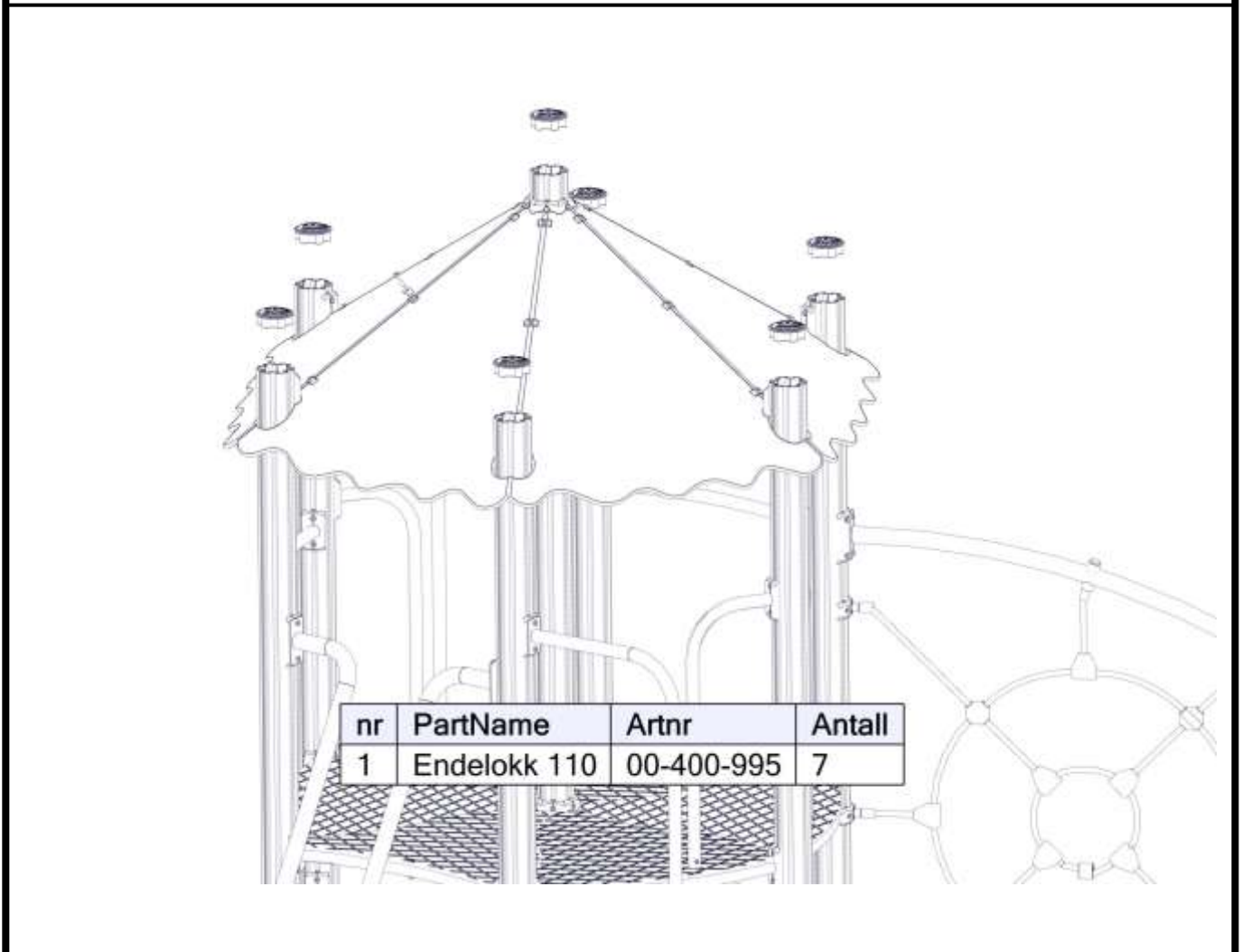
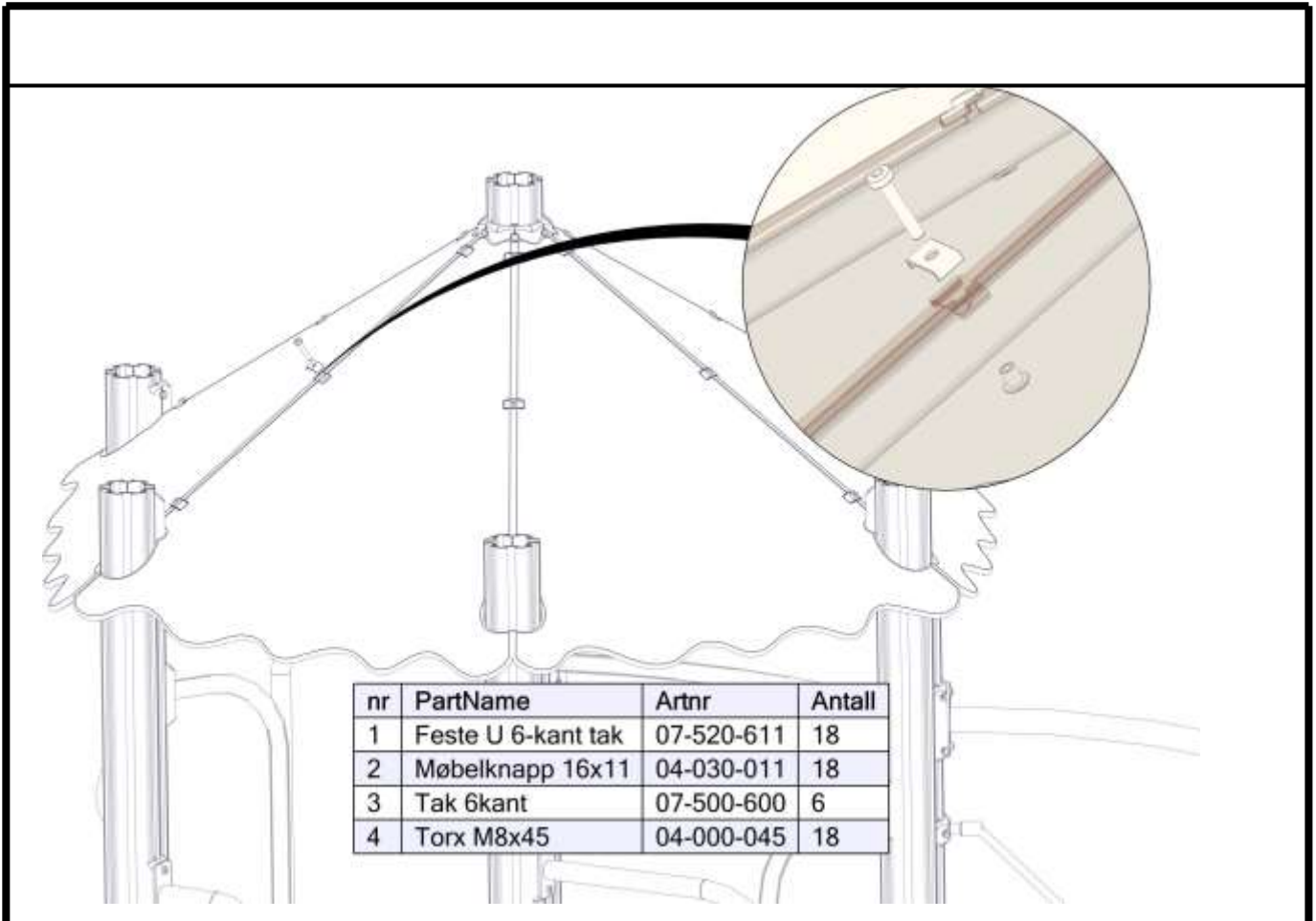

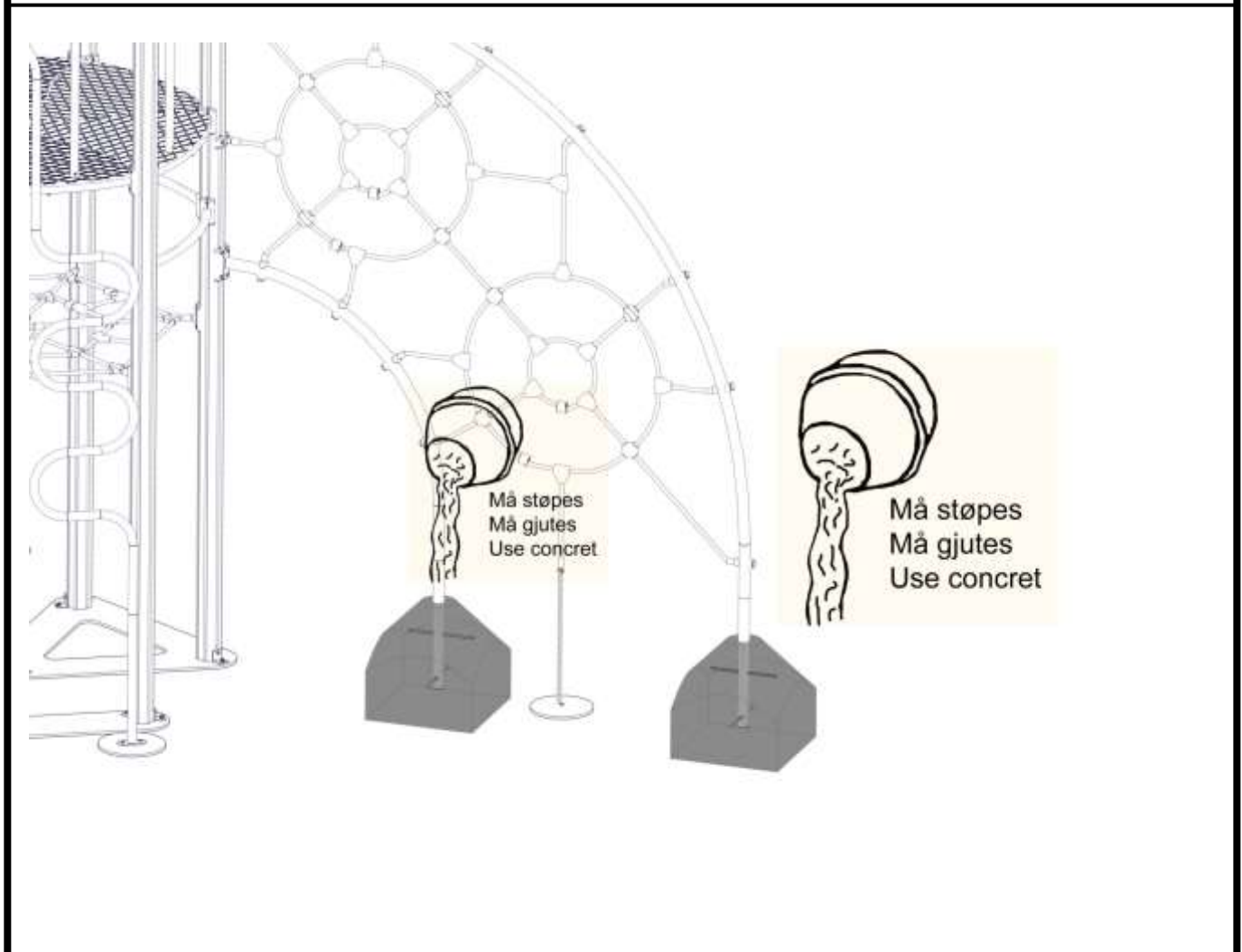
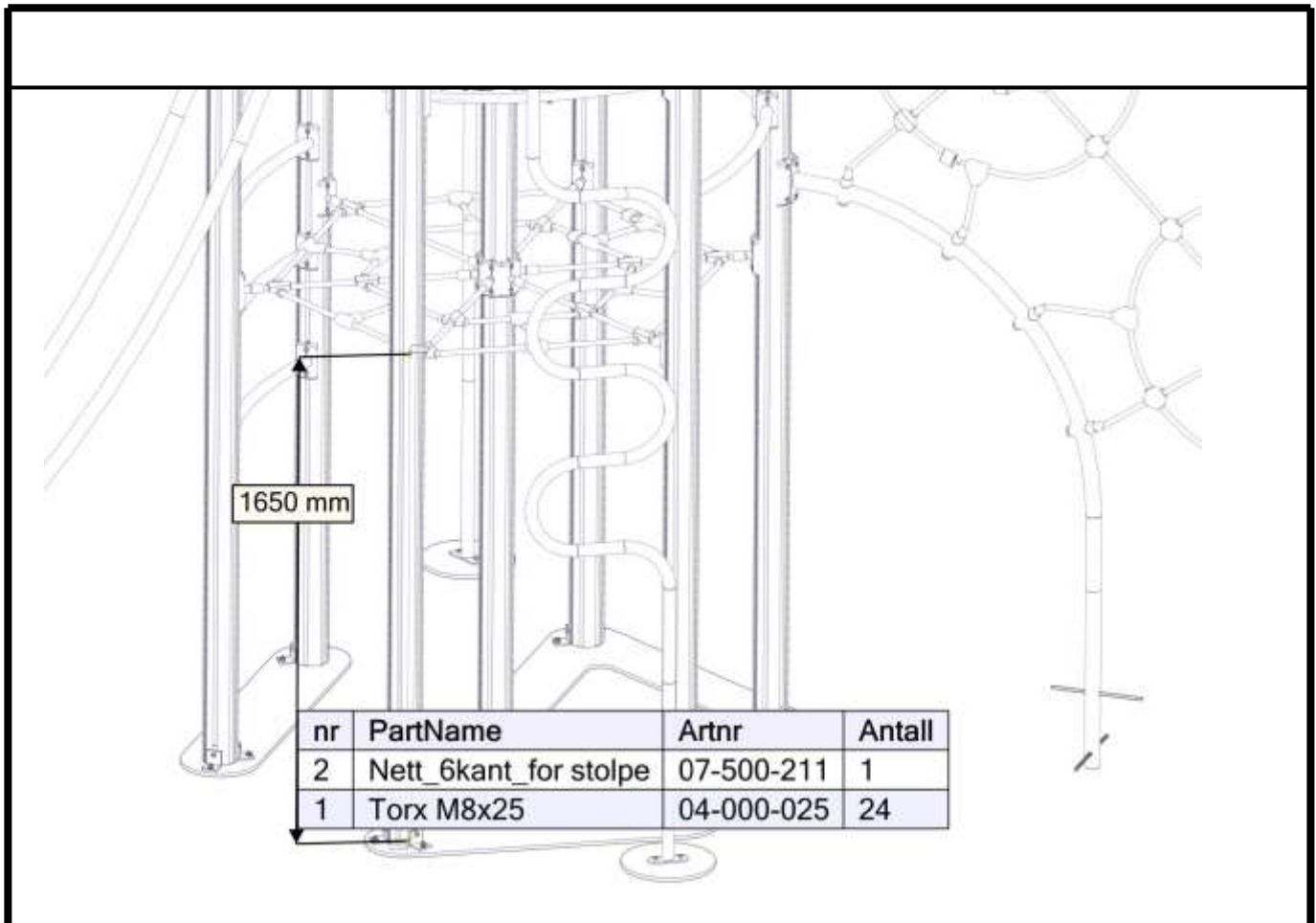









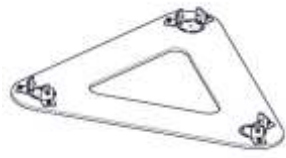











nr	PartName	Artnr	Antall
1	Brikke 150 2xM8	04-060-151	2
2	Sekskant M8x35	04-028-035	4
3	Rustfritt skive M8	04-058-008	4
4	Sperrerør 6kant tak	07-150-062	1











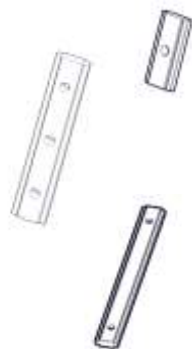
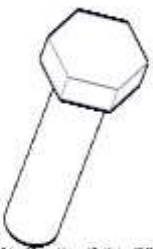



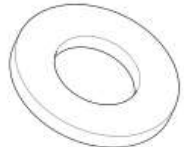

Før utstyret tas i bruk / Before play begins / Innan lekredskapet tas i bruk	
N	<ul style="list-style-type: none"> ● Påse at fallunderlag er utlagt i henhold til gjeldende regler eller vår anbefaling ● Fjern alle monteringshjelpemidler (rester av betong, planker, paller, plast, og lignende) ● Før utstyret tas i bruk, burde man sjekke at det ikke er fare for at anorakksnorer og lignende som kan hekte seg fast noen steder på lekeapparatet. (Vedlagte snor med dobbe (kneledd) kan brukes til å sjekke at dette er i orden. Se vedlagte veiledning for bruk av denne. Dette gjøres for å oppdage eventuelle feilmonteringer.?) ● NB! Bør stå i 2-3 dager før bruk
EN	<ul style="list-style-type: none"> ● Make sure the area and depth of safer surfacing are according to the current standard, or to the manufacturer's recommendation ● Make sure all tools and surplus materials are removed before play begins ● PS! When complete, allow 2-3 days for the concrete to set before use
S	<ul style="list-style-type: none"> ● Kontrollera att fallunderlag är utlagt enligt gällande regler eller vårt rekommendation ● Ta bort alla monteringshjälpmedel (rester av betong, plankor, pallar, plast och liknande) ● Innan lekredskapet används, kontrollera att anoracksnoddar eller kläder/delar av kläder eller liknande inte kan fastna i några delar på redskapet. (Den bipackade "knävringen" kan man med fördel användas för denna kontroll. ● Detta görs för att upptäcka eventuella felmonteringar.)

komponenter		Sign. _____.	
	Stolpe L=4000 600-3400 6 Stolpe L=4500 600-3900 1		Endelokk 00-400-995 7
	Sluse 07-150-064 3		Sperrerør bøyet 07-150-060 8
	Sperrerør gulv 07-150-064 6 Rett + 2 hull		Sperrerør gulv 07-150-061 6
	Fundament 3 07-400-003 1		Gulv 6 kant Slider 07-301-121 1 Grå
	Fundament 2 07-400-002 2		Gulv 6 kant 07-301-120 5 Grå
	Brannstang 07-200-037 1		S-trepp 07-200-028 1
	6kant rund nett FOR STOLPE 07-500-211 1 Med 0gr beslag		Slider rør 07-200-021 1 Høyre og venstre del
	Prouktmerke på 150 beslag 1		FundamentplateSlider 07-200-022 1

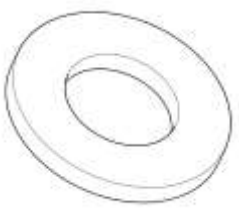
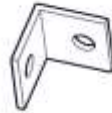
komponenter		Sign. _____.			
	6kant tak 07-500-600 Grå	6		Feste U 6kant tak 07-520-611	18
	Sperrørør 6 kant tak 3 hull 07-150-064	6		Ogr beslag 150_2T 07-150-022	2
			Ogr beslag 120_2T 07-150-020		2
	Dobbeltedder- kopp nett 07-500-018	1		30gr beslag 150_4H2T 07-150-041	2
				30gr beslag 50_2H1V 07-150-040	0
			Montert!		
	Rør dobbelt edderkoppnett 07-200-015 07-200-016	1 1		Armering 03-191-013	4

komponenter		Sign. _____			
	Torx M8x25 04-000-025	150		Brikke 50-1T 04-060-050	18
	Torx M8x30 04-000-030	14		Brikke 120-3T 04-060-120	33
	Torx M8x35 04-000-035	18		Brikke 150-2T 04-060-151	19
	Torx M8x45 04-000-045	49			
	Sekskant M8x35	24		Låsemutter M8 04-040-008	22
	Rustfritt			Låsemutter M10 04-040-010	11
	Møbelknapp M8x13x17 04-030-011	36		Hylsemutter M8 12-38 04-018-060	3
	PlastRørdel 05-300-036	20		Plast rørdel end 05-300-036	10
	Skive Polyfix 05-300-036	20		Skive M10 04-050-010	1
	Cover				
	Plast plugg 9-11mm 04-090-002	10		Fundamentplate 00-003-010	3
	Skive M8 04-050-008	8		Vinkel 50x50x50 04-070-050 11mm	14
	Skive M8 04-055-008	31			
	Skive M8 04-048-008 Rustfritt	24		Bit Torx TX45 04-001-045	1