

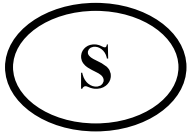

Monteringsanvisning



Assembly Instructions



Monteringsanvisning

Produkt nr. / Product no. / Produkt nr.

30-189-100

Ordr. nr. _____

Dato. _____

Sign. _____

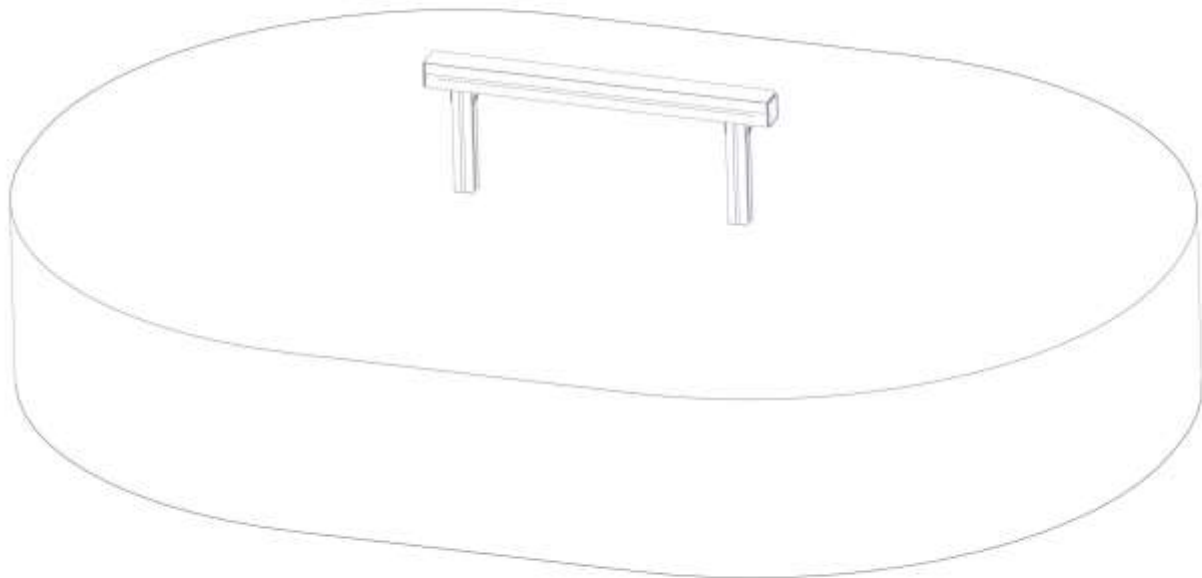

søve

Søve AS
Grønnvoldveien 290
3830 Ulefoss - Norway
Tlf: +47 35 94 65 65
www.sove.no



søve

Søve AB
EA Rosengrens-gatan 32
421 31 Västra Frölunda
Phone: +46 (0)31 773 97 00
www.sove.se

Monteringstips / Assembly Advice / Monteringsstips

N

- Les monteringsanvisningen nøye før montering.
- Monter elementene i rekkefølgen som vist.
- Boltene bør ikke skrues for hardt til før alt er montert, vatret og loddet. Skru så boltene til.
- NB! Ved bruk av drill, kan boltene ryke.
- På grunn av at solen kan gjøre rutsjeflaten veldig varm, bør rutsjebanens utløp vende mot nord-øst eller nord-vest.
- Er lekeutstyret plassert i naturlige ferdselstraséer må området sikres mot gjennomgang.
- Innspringningshinder bør vurderes rundt lekeapparater hvor det er stor bevegelse, f.eks. ved huskestativ.
- Det bør være fritt innsyn til lekeutstyr som er beregnet for barn under 3 år.

NB! Under monteringsarbeidet må utstyr, som ikke er forankret forsvarlig i bakken, sikres slik at det ikke velte.

Området må avstenges under montering av apparatene med sperrebånd eller lignende.

EN

- Read the instruction carefully before assembling the play unit.
- Assemble the components in the sequence shown in these instructions.
Fixings must not be fully tightened during assembly. Before casting the foundations, the structure must be level and plumb, at which point all fixings are tightened.
PS! If use of drill, the bolts may be wrecked.
- Avoid positioning the slide facing due south because of overheating – ideal positions are facing north-east or north-west.
Secure the construction-area to prevent people from walking through it.
- Consider installing barriers around play-equipment which gives rise to a lot of activity – i.e. swings.
- Ensure that clear vision is possible across the play area so that supervision is possible from any position, particularly where children under 3 years of age will be playing.

NB! During assembly of the equipment, ensure that all structures are securely propped, especially when left overnight. Also ensure that equipment is supported

Monteringstips / Assembly Advice / Monteringsstips

S

- Läs monteringsanvisningen noga före montering.
- Montera delarna i den ordningen som anvisas
- Skruvarna bör inte skruvas för hårt tills allt är monterat, i våg och lodat.









OBS! Används elektrisk skruvdragare, kan bulten gå sönder. Hårdra därför manuellt!

- Om lekplatsen placeras vid en gångväg mm bör området säkras mot genomfart av gående och cyklister.
- Inspringshinder bör placeras runt lekutrustning med stor rörelse, t ex, gungställning.
- Det bör vara fri insyn till lekutrustning beräknat till barn under 3 år.

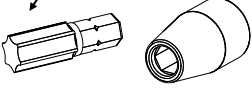
OBS! Under monteringsarbete bör utrustningen som inte ska förankras i marken, ställs så att den inte kan välta.

Området måste spärras när lekutrustningen byggs upp, med avspärrningsband eller liknande.

Nødvendig verktøy / Tools required / Nödvändiga verktyg

<p>(N)</p> <p>(EN)</p> <p>(S)</p>	<p>(A)</p> 	<p>(B)</p>  <p>Torx Nr 45 High quality</p> 	<p>(C)</p>	<p>(D)</p> 	
		<p>Metermål</p> <p>Metric measure</p> <p>Tumstock</p> 	<p>16 V</p> 	<p>Merkebånd</p> <p>Mark ribbon</p> <p>Märkeband</p> 	

Nødvendig antall personer / Number of persons required / Rekommenderad antal personer





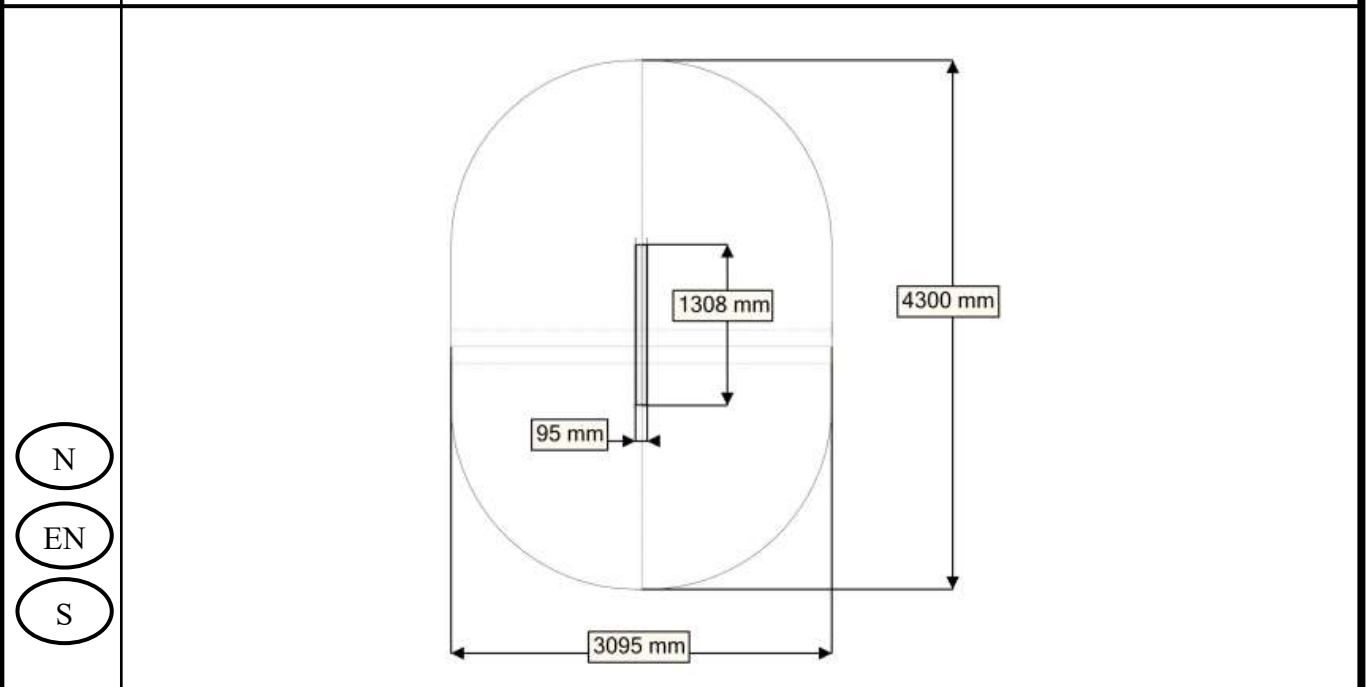

Anbefalt arealbehov ved montering / Recommended working space / Rekommenderad arealbehov vid montering



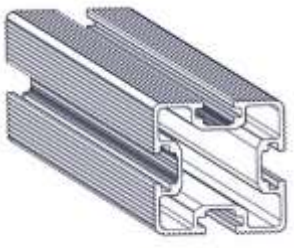

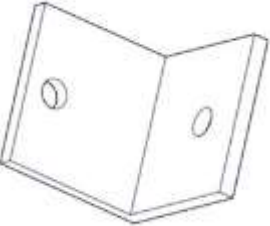
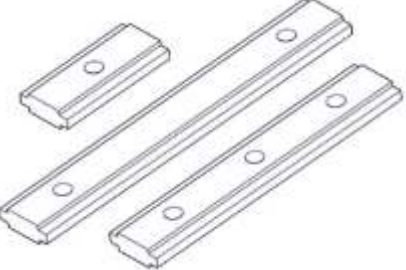
Boltepakker for / Boltpackage for / Bultpaket för

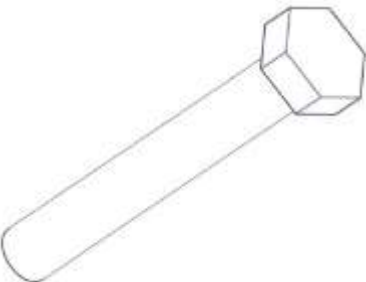
Sign. _____

Balansebom	Navn	Artnr/dimensjon	Ant	Lev
	Stolpe 70x70 L=1000 600-400 (1)	SFA5123 /1 Sort	2	
	Balansebom 95x107x1300 95x95 L=1300 Med 4x brikke	01-400-411	1	
	Vinkel 50x50x50x5 9mm hull	04-075-050	4	
	Brikke 50 1xM8	04-060-050	12	
	Torx M8x20	04-000-020	8	
	Sekskant M8x65(4)	04-008-065	8	

Boltepakker for / Boltpackage for / Bultpaket för

Sign. _____.

Balansebom	Navn	Artnr/dimensjon	Ant	Lev
	End lokk 70x70 m/ hull	00-400-999	2	
	Produktmerke Montert	30-189-100	1	

Fundamentering med betong / Foundation concrete / Förankring med betong

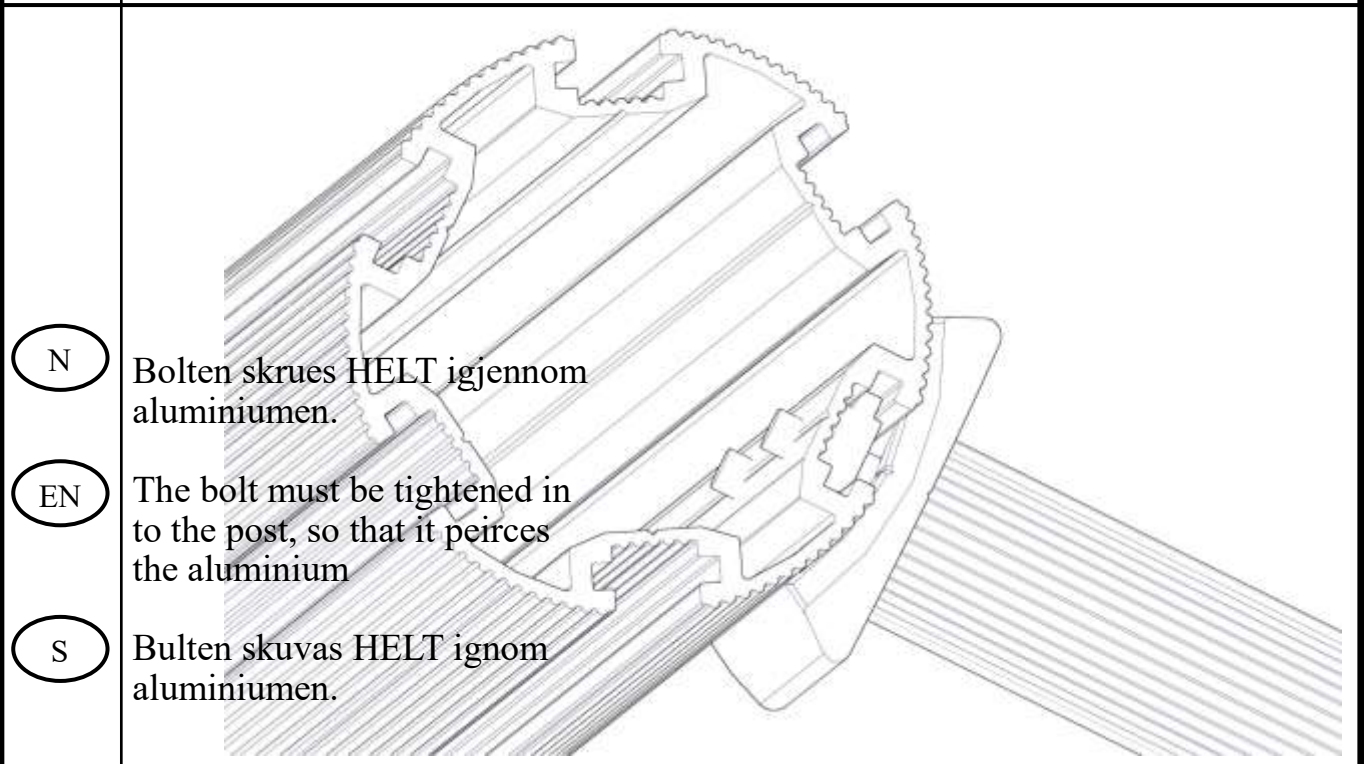
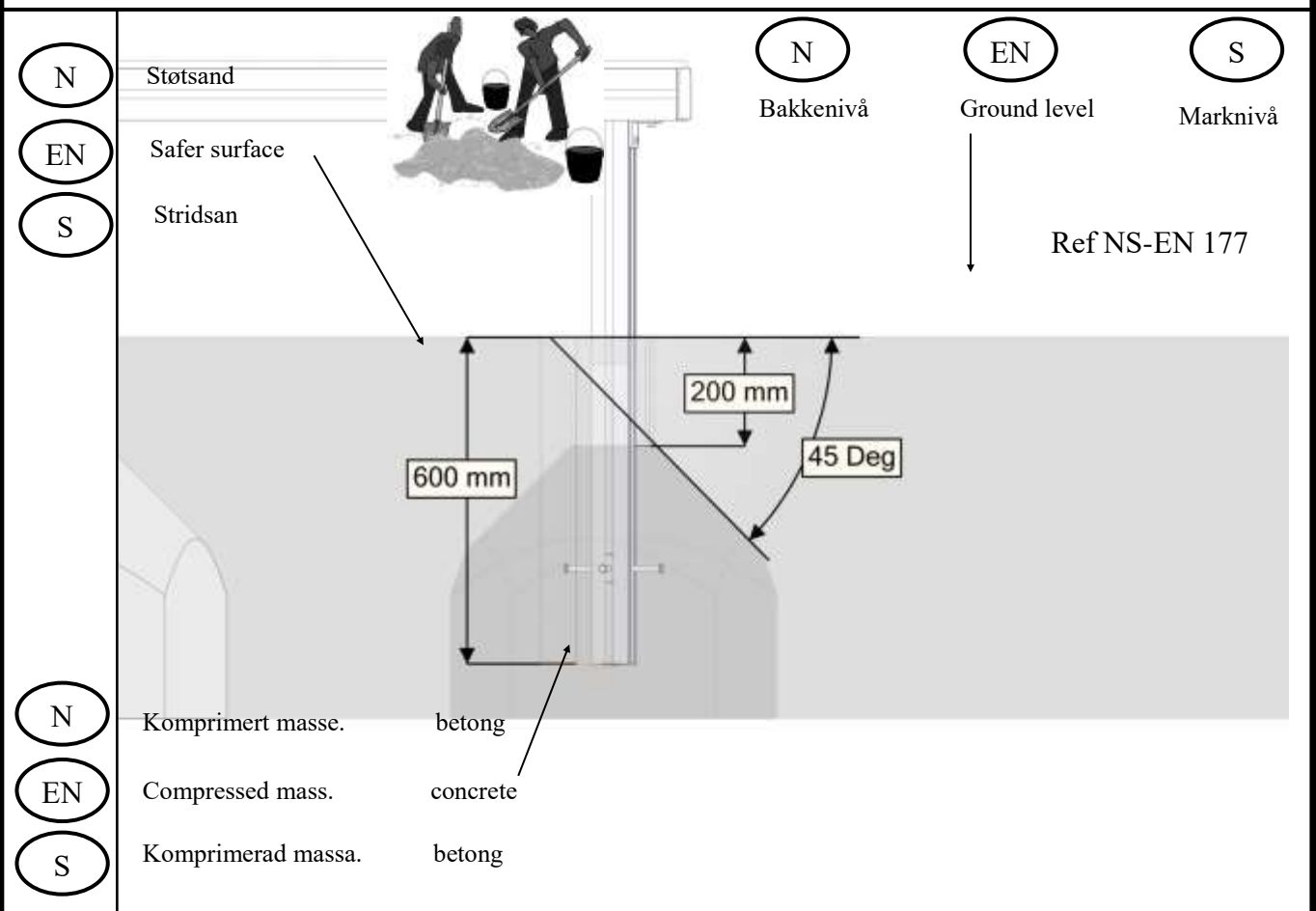

(N) Alle mål er oppgitt i millimeter

(EN) Scale measured in mm

(S) Alla mått är i millimeter.

Fallhøyder / Free height of fall / Fallhöjder

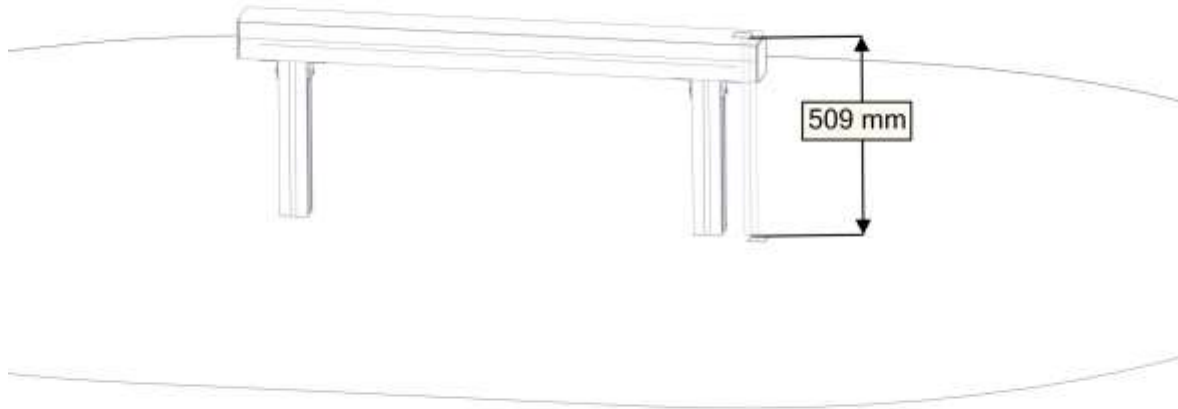

Sikkerhetszone / Safety zone / Säkerhetszon

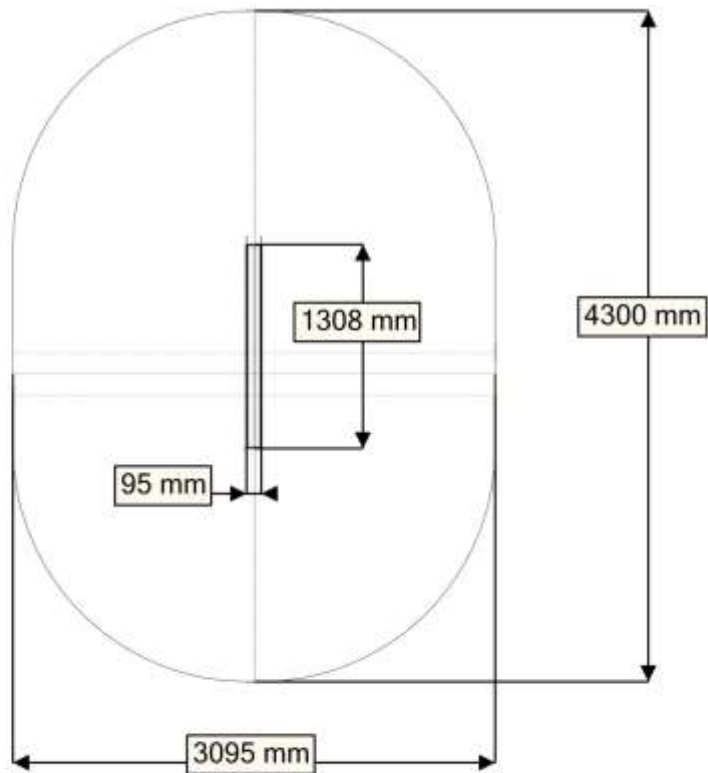

Montering av lekeapparatet / Assembly instructions / Montering av lekredskapet

2x

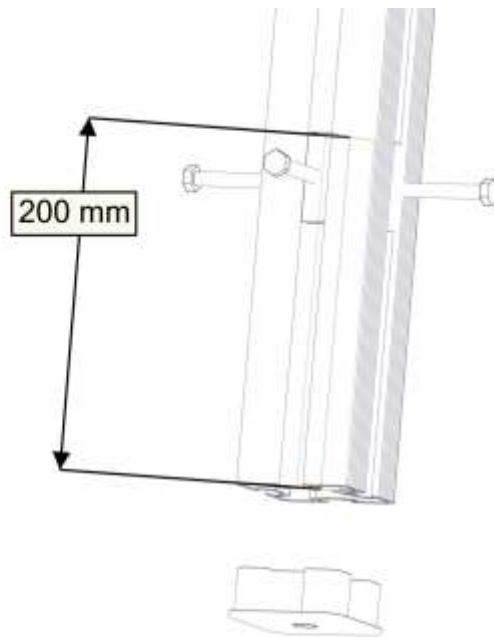

nr	PartName	Artnr	Antall
1	Brikke50 1XM8	04-060-050	4
2	Sekskant M8x65	04-008-065	4
3	Endelokk 70x70 med hull	00-400-996	1

2x

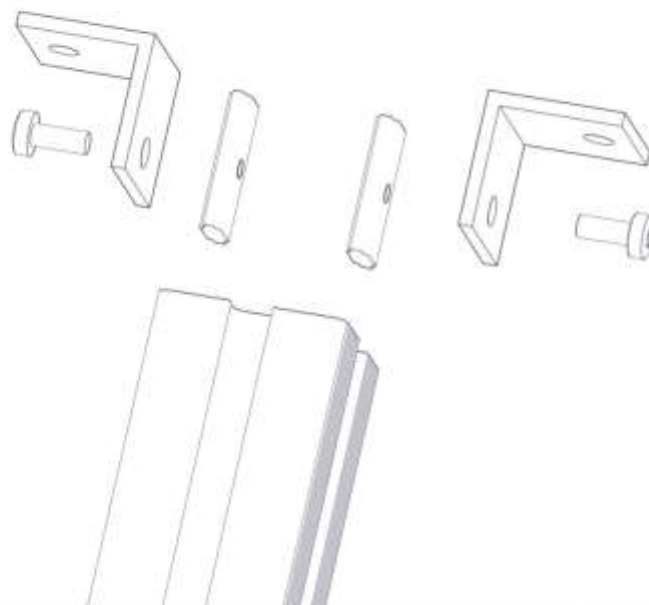

nr	PartName	Artnr	Antall
1	Torx M8x20	04-000-020	2
2	Brikke50 1XM8	04-060-050	2
3	Vinkel 50x50x50x5 11mm hull	04-070-050	2

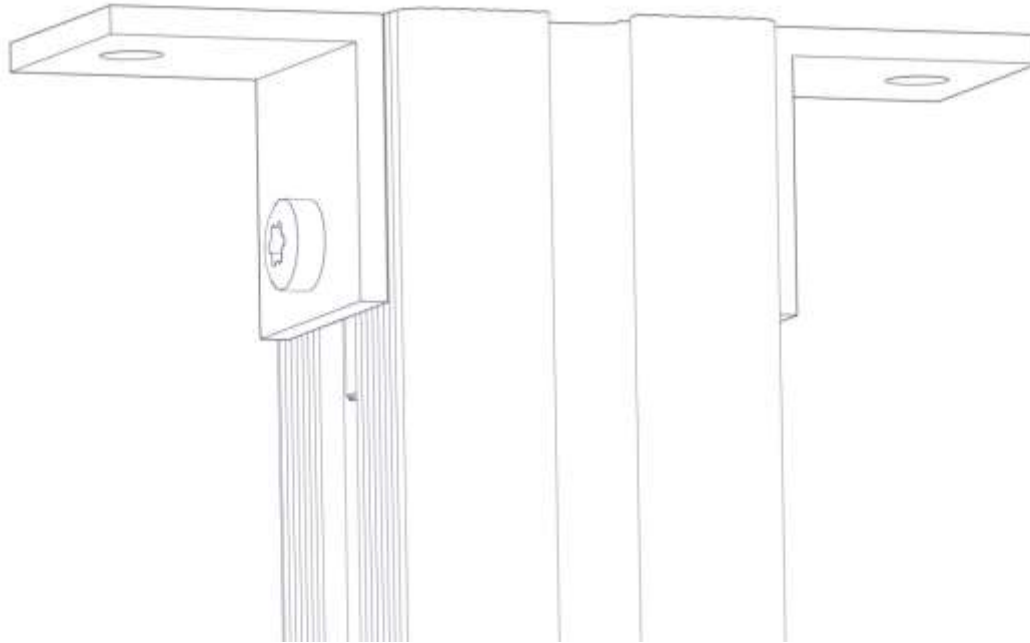
Montering av lekeapparatet / Assembly instructions / Montering av lekredskapet

nr	PartName	Artnr	Antall
1	Torx M8x20	04-000-020	4



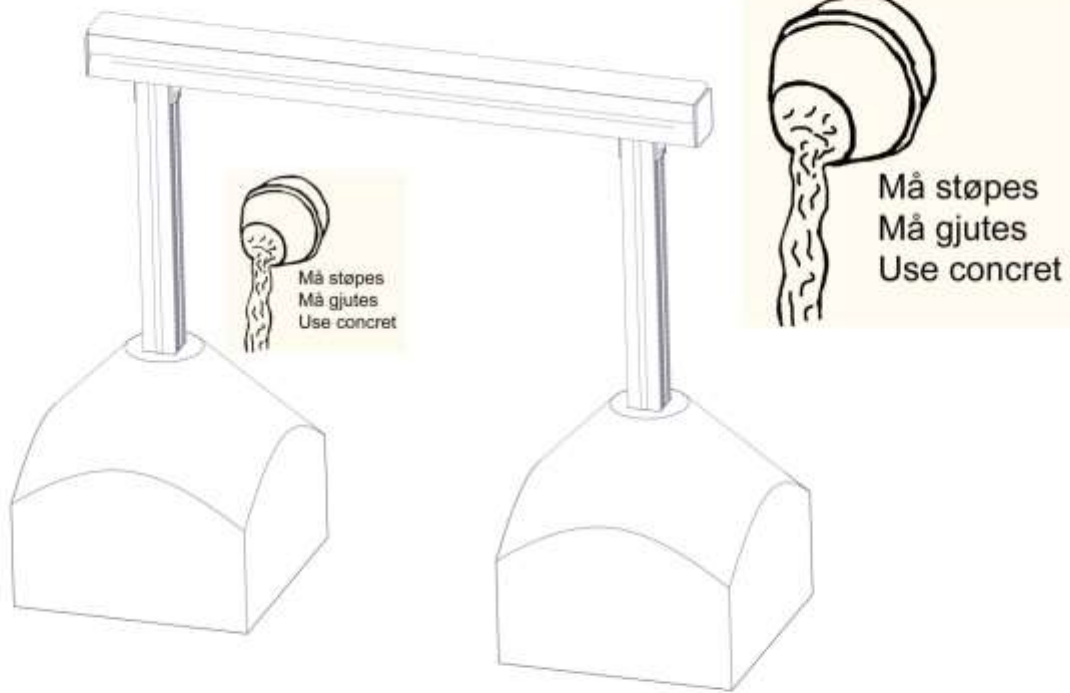

Montering av lekeapparatet / Assembly instructions / Montering av lekredskapet



Før utstyret tas i bruk / Before play begins / Innan lekredskapet tas i bruk	
N	<ul style="list-style-type: none"> ● Påse at fallunderlag er utlagt i henhold til gjeldende regler eller vår anbefaling ● Fjern alle monteringshjelpemidler (rester av betong, planker, paller, plast, og lignende) ● Før utstyret tas i bruk, burde man sjekke at det ikke er fare for at anorakksnorer og lignende som kan hekte seg fast noen steder på lekeapparatet. (Vedlagte snor med dobbe (kneledd) kan brukes til å sjekke at dette er i orden. Se vedlagte veiledning for bruk av denne. Dette gjøres for å oppdage eventuelle feilmonteringer.?) ● NB! Bør stå i 2-3 dager før bruk
EN	<ul style="list-style-type: none"> ● Make sure the area and depth of safer surfacing are according to the current standard, or to the manufacturer's recommendation ● Make sure all tools and surplus materials are removed before play begins ● PS! When complete, allow 2-3 days for the concrete to set before use
S	<ul style="list-style-type: none"> ● Kontrollera att fallunderlag är utlagt enligt gällande regler eller vårt rekommendation ● Ta bort alla monteringshjälpmedel (rester av betong, plankor, pallar, plast och liknande) ● Innan lekredskapet används, kontrollera att anoracksnoddar eller kläder/delar av kläder eller liknande inte kan fastna i några delar på redskapet. (Den bipackade "knävringen" kan man med fördel användas för denna kontroll. ● Detta görs för att upptäcka eventuella felmonteringar.)

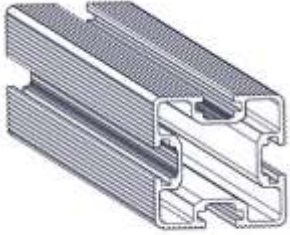

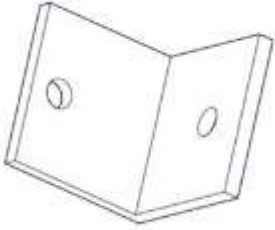
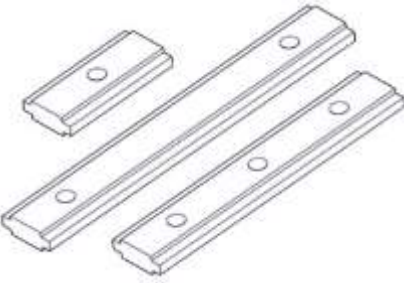
Boltepakker for / Boltpackage for / Bultpaket för

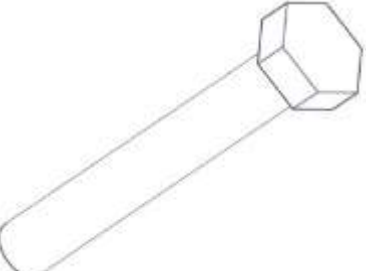
Sign. _____

Balansebom	Navn	Artnr/dimensjon	Ant	Lev
	Stolpe 70x70 L=1000 600-400 (1)	SFA5123 /1 Sort	2	
	Balansebom 95x107x1300 95x95 L=1300 Med 4x brikke	01-400-411	1	
	Vinkel 50x50x50x5 9mm hull	04-075-050	4	
	Brikke 50 1xM8	04-060-050	12	
	Torx M8x20	04-000-020	8	
	Sekskant M8x65(4)	04-008-065	8	

Boltepakker for / Boltpackage for / Bultpaket för

Sign. _____.

Balansebom	Navn	Artnr/dimensjon	Ant	Lev
	End lokk 70x70 m/ hull	00-400-999	2	
	Produktmerke Montert	30-189-100	1	