

**N****Monteringsanvisning****EN****Assembly Instructions****S****Monteringsanvisning**

Produkt nr. / Product no. / Produkt nr.

**26-100-010**

Ord.. nr. \_\_\_\_\_

Dato. \_\_\_\_\_

Sign. \_\_\_\_\_

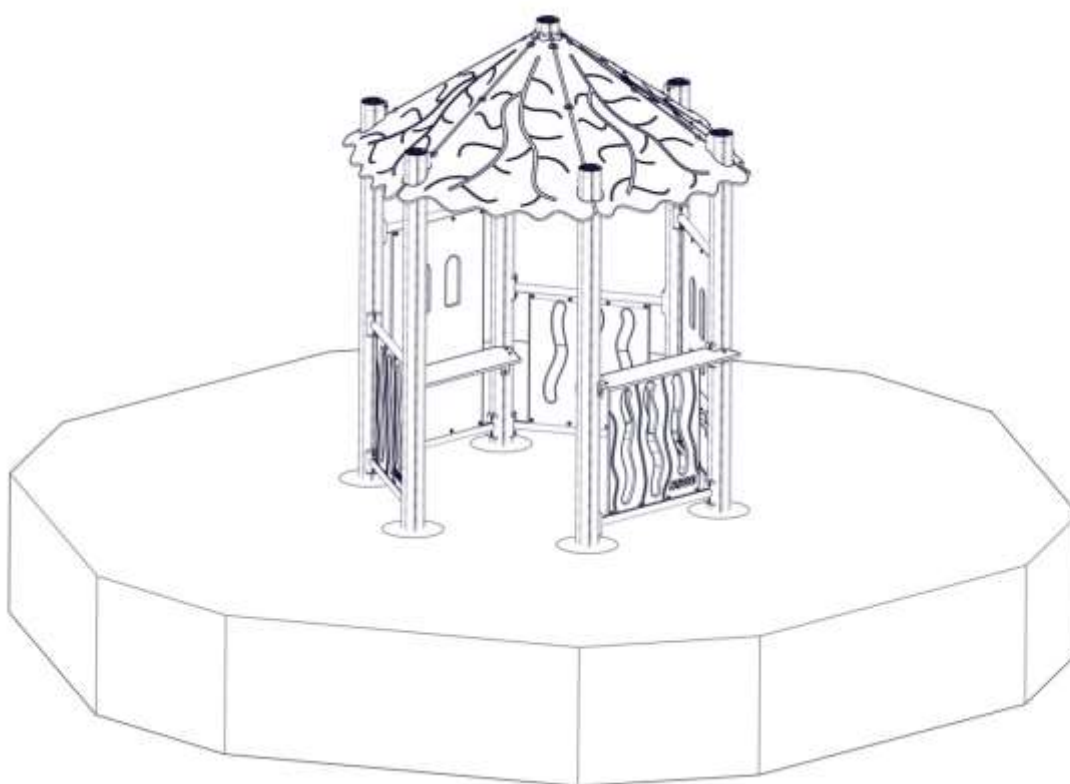
**sove**

Søve AS  
3830 Ulefoss - Norway  
Tlf: +47 35 94 65 65  
[www.sove.no](http://www.sove.no)



Søve AB  
EA Rosengrensgatan 32  
421 31 Västra Frölunda  
Phone: +46 (0)31 773 97 00  
[www.sove.se](http://www.sove.se)

## Monteringstips / Assembly Advice / Monteringsstips

**N**

- Les monteringsanvisningen nøye før montering.
- Monter elementene i rekkefølgen som vist.
- Boltene bør ikke skrues for hardt til før alt er montert, vatret og loddet. Skru så boltene til.
- NB! Ved bruk av drill, kan boltene ryke.
- Er lekeutstyret plassert i naturlige ferdselstraséer må området sikres mot gjennomgang.
- Innspringningshinder bør vurderes rundt lekeapparater hvor det er stor bevegelse, f.eks. ved huskestativ.
- Det bør være fritt innsyn til lekeutstyr som er beregnet for barn under 3 år.

**NB! Under monteringsarbeidet må utstyr, som ikke er forankret forsvarlig i bakken, sikres slik at det ikke velte.**

**Området må avstenges under montering av apparatene med sperrebånd eller lignende.**

**EN**

- Read the instruction carefully before assembling the play unit..
- Assemble the components in the sequence shown in these instructions.
- Fixings must not be fully tightened during assembly. Before casting the foundations, the structure must be level and plumb, at which point all fixings are tightened.
- PS! If use of drill, the bolts may be wrecked.
- Secure the construction-area to prevent people from walking through it.
- Consider installing barriers around play-equipment which gives rise to a lot of activity – i.e.swings.
- Ensure that clear vision is possible across the play area so that supervision is possible from any position, particularly where children under 3 years of age will be playing.

**NB! During assembly of the equipment, ensure that all structures are securely propped, especially when left overnight. Also ensure that equipment is supported whilst concrete foundations are setting and enclose the area securely to prevent access.**

## Monteringstips / Assembly Advice / Monteringsstips

**S**

- Läs monteringsanvisningen noga före montering.
- Montera delarna i den ordningen som anvisas
- Skruvarna bör inte skruvas för hårt tills allt är monterat, i våg och lodat.









OBS! Används elektrisk skruvdragare, kan bulten gå sönder. Hårdra därför manuellt!

- Om lekplatsen placeras vid en gångväg mm bör området säkras mot genomfart av gående och cyklister.
- Insprängningshinder bör placeras runt lekutrustning med stor rörelse, t ex, gungställning.
- Det bör vara fri insyn till lekutrustning beräknat till barn under 3 år.

**OBS! Under monteringsarbete bör utrustningen som inte ska förankras i marken, ställs så att den inte kan välta.**

**Området måste spärras när lekutrustningen byggs upp, med avspärrningsband eller liknande.**

**Nødvendig verktøy / Tools required / Nödvändiga verktyg**

<p>(N)</p> <p>(EN)</p> <p>(S)</p>	<p>(A)</p> 	<p>(B)</p>  <p>Torx Nr 45 High quality</p>	<p>(C)</p>	<p>(D)</p> 	<p>(E)</p> 
		<p>Metermål</p> <p>Metric measure</p> <p>Tumstock</p> 	<p>16 V</p> 	<p>Merkebånd</p> <p>Mark ribbon</p> <p>Märkeband</p> 	

**Nødvendig antall personer / Number of persons required / Rekommenderad antal personer**



**Anbefalt arealbehov ved montering / Recommended working space / Rekommenderad arealbehov vid montering**

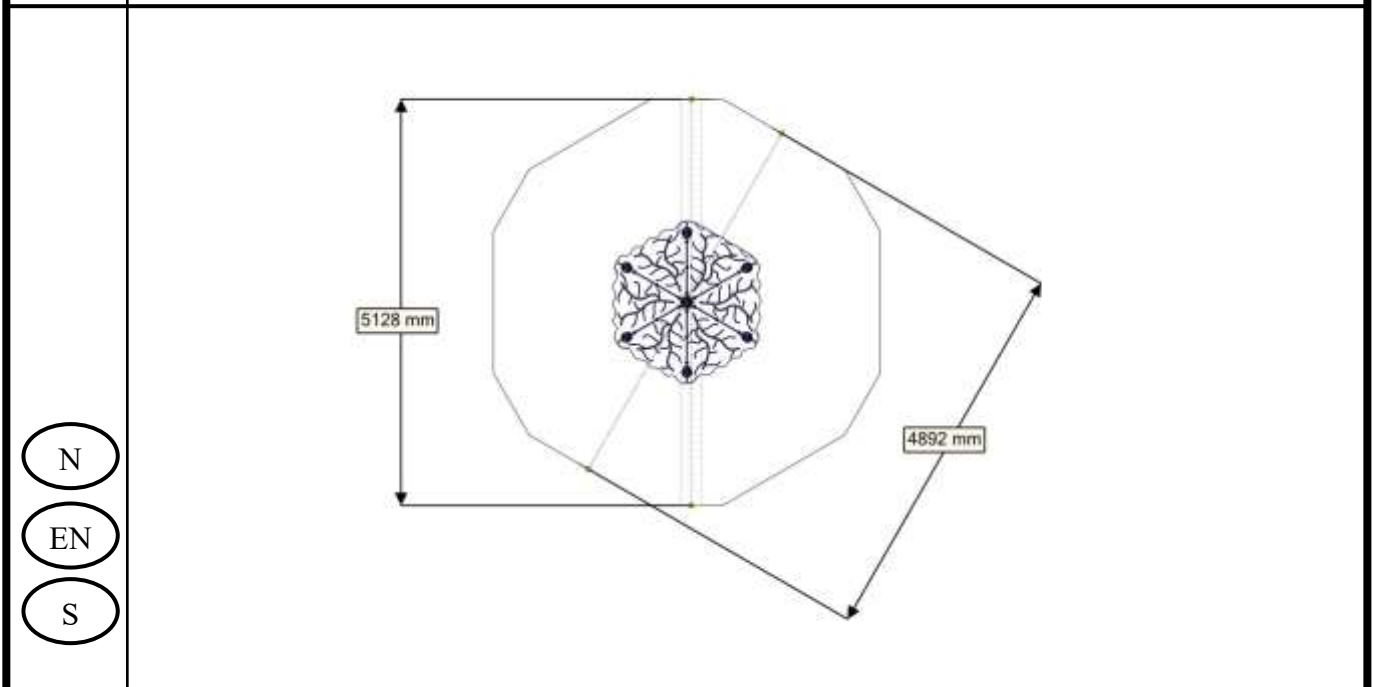

**Fallhøyder / Free height of fall / Fallhöjder**

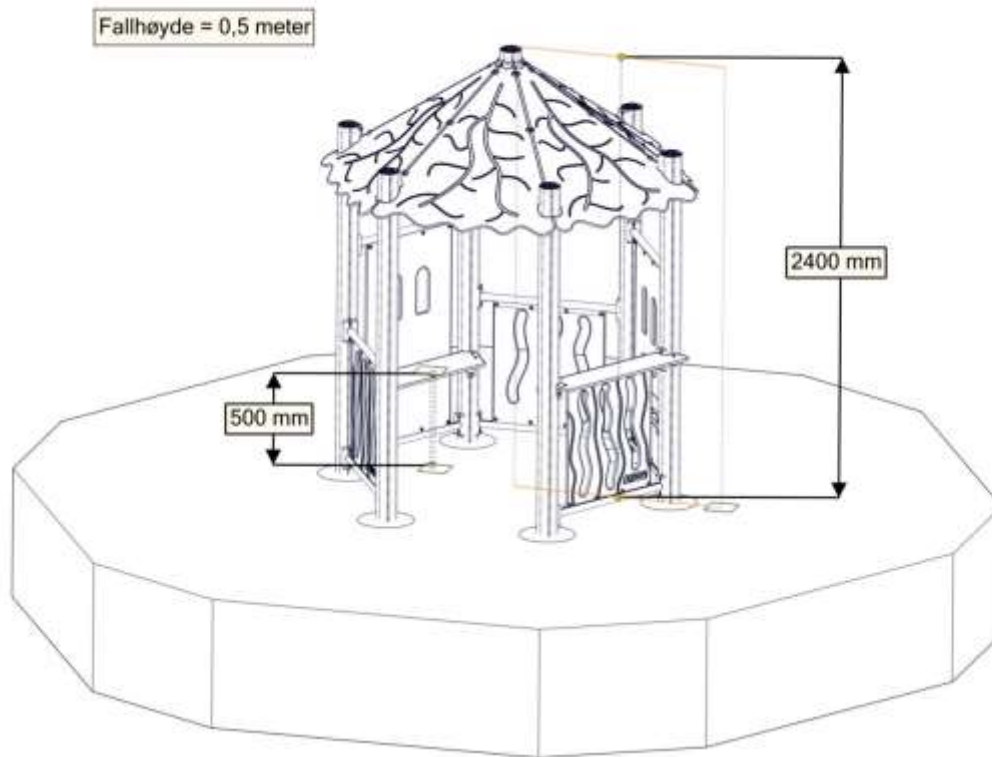

**Sikkerhetszone / Safety zone / Säkerhetszon**

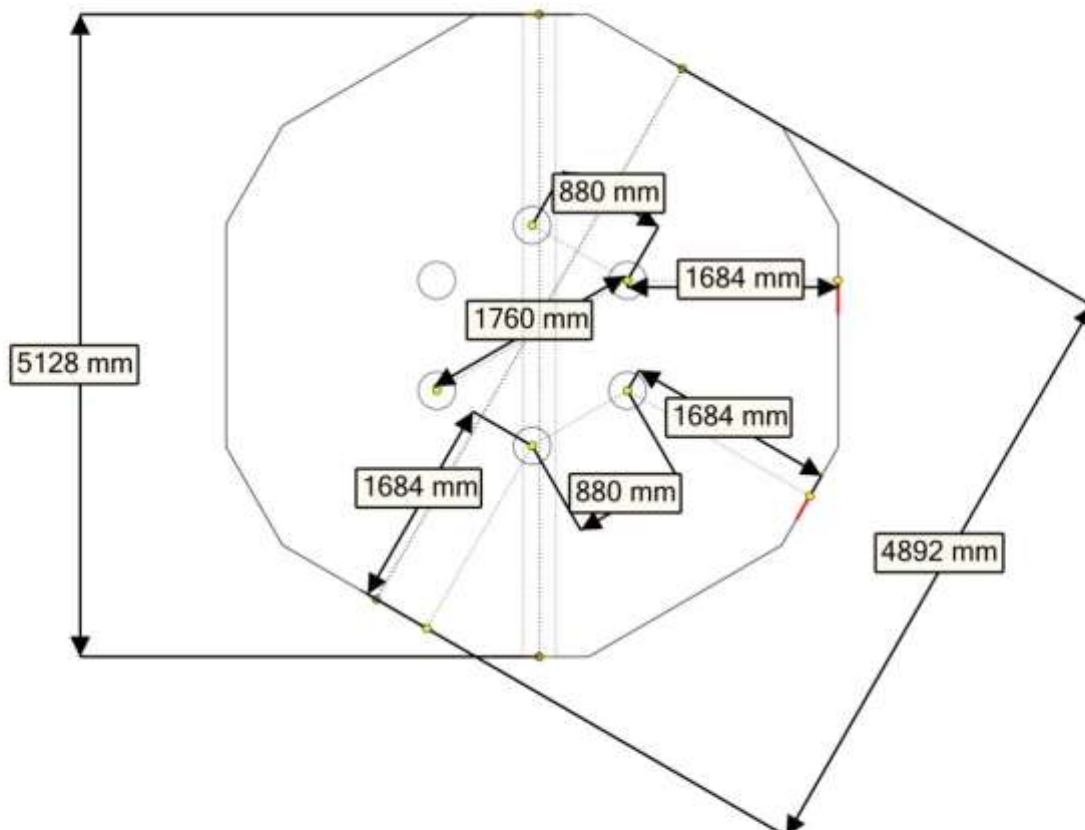

### Plassering av forankringer / Ground plan / Placering av förankringar

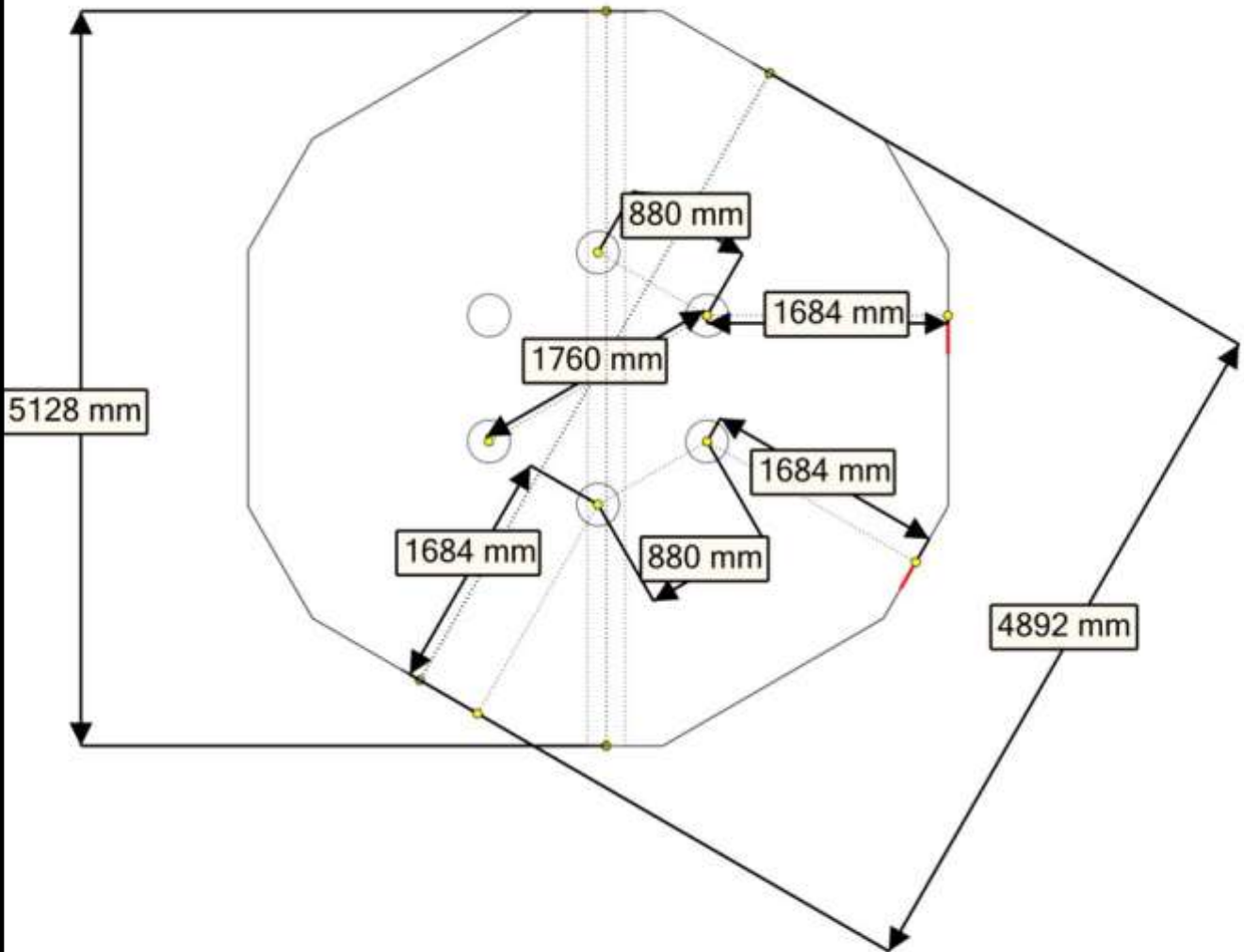

N

Alle mål er oppgitt i millimeter

EN

Scale measured in mm

S





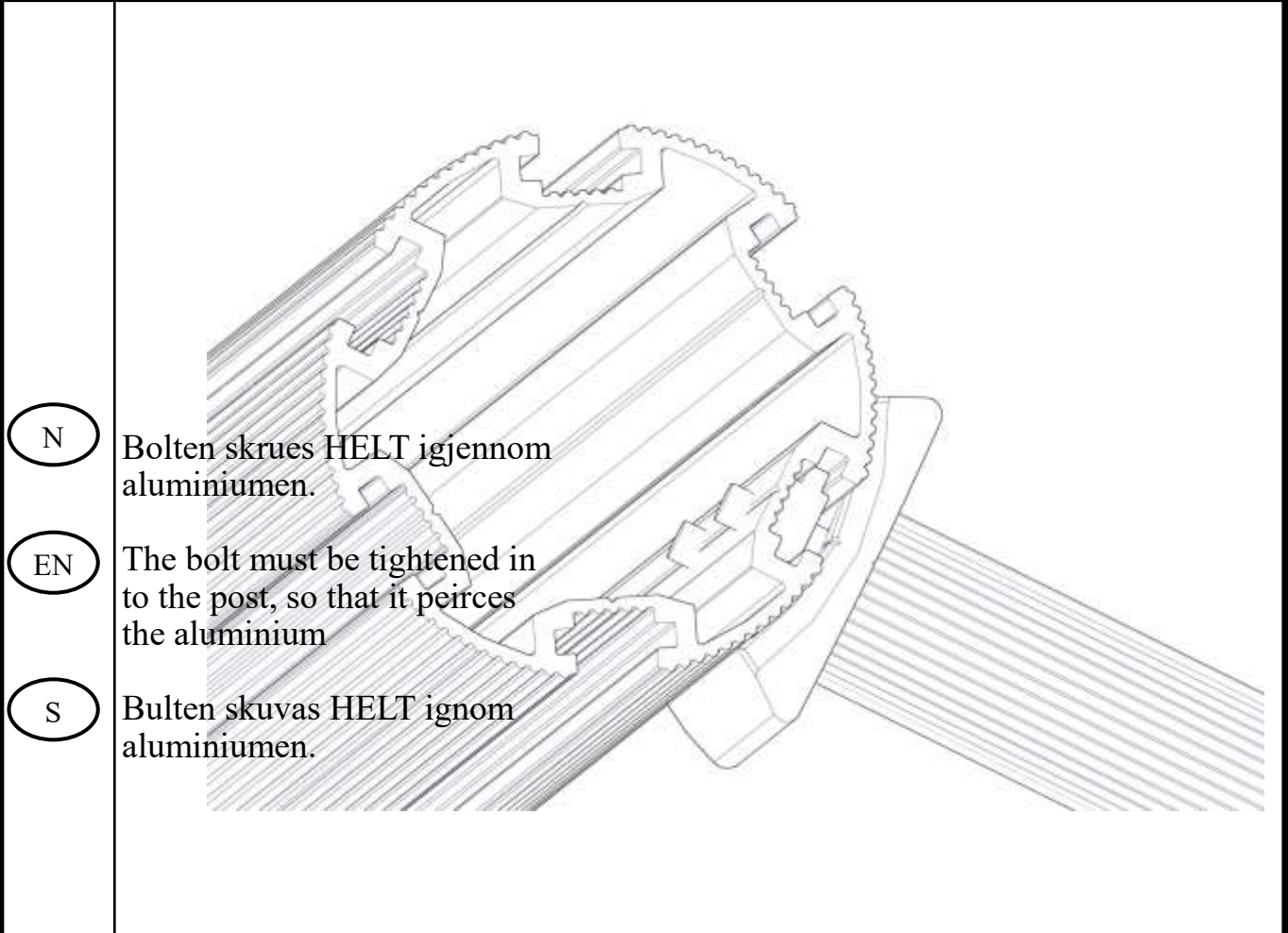
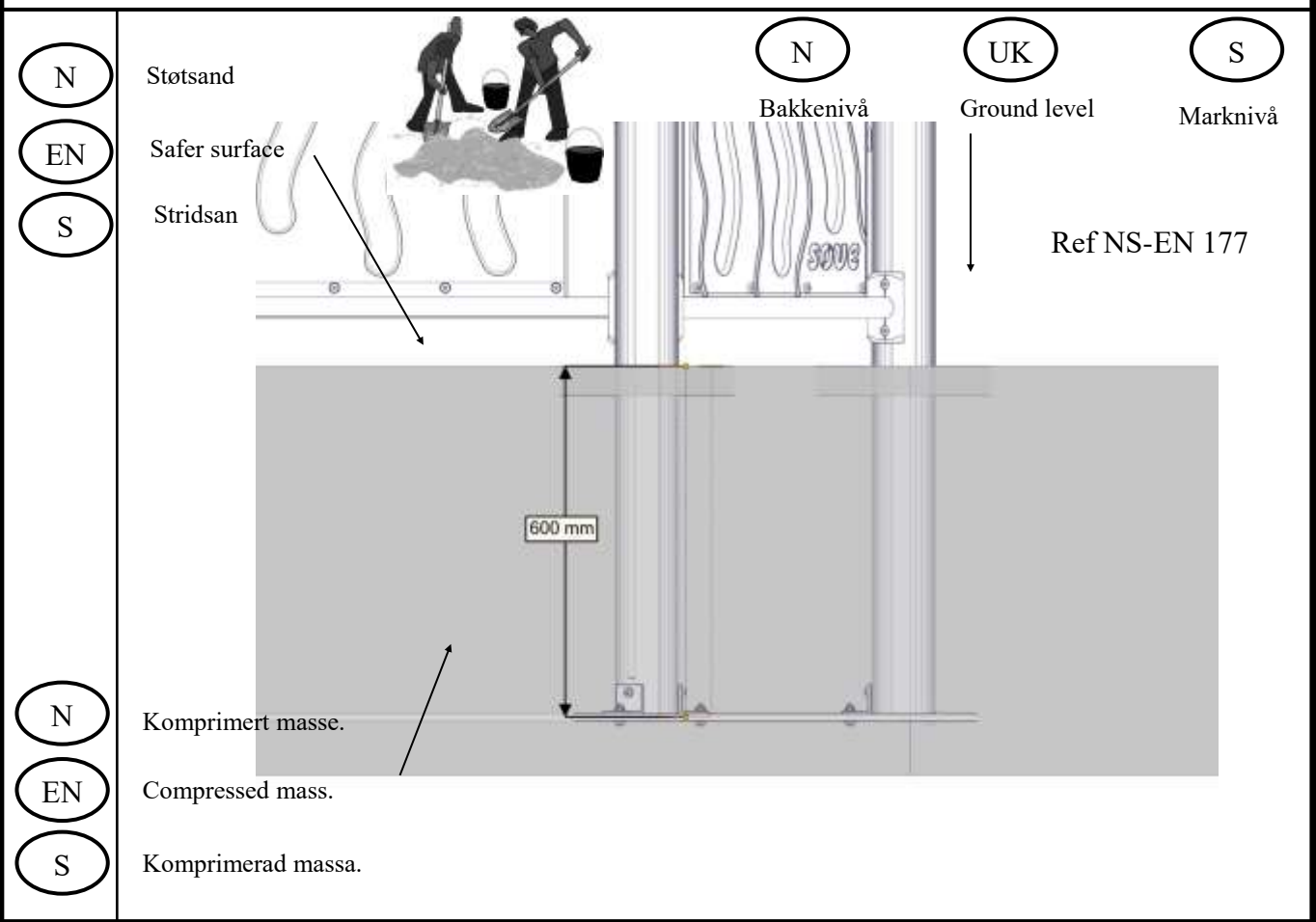







Alla mått är i millimeter.

**Fundamentering uten betong / Foundation without concrete**



**Boltepakker for / Boltpackage for / Bultpaket för**













Sign. \_\_\_\_\_

Stolpe 110	Ant= 4	Navn	Artnr/dimensjon	Ant	Lev
		Stolpe 110 L=2500 600-1900 (6) Stolpe 110 L=200	07-100-334 07-100-334	6 1	
Stolpende	Ant= 8	Navn	Artnr/dimensjon	Ant	Lev
		Endelokk (1)	00-400-995	8	
Produktmerke	Ant= 1	Navn	Artnr/dimensjon	Ant	Lev
		Ogr 150_2H (1) Med Produktmerke	07-500-500	1	
		Brikke 150_2T(1)	04-060-151	1	
		Torx M8x35 (2)	04-000-035	2	
Fundament 07-400-102 2stolpe	Ant= 3	Navn	Artnr/dimensjon	Ant	Lev
		Dobbel fun plate (1)	07-400-002	3	
		Vinkel 50x50x50(4)	04-070-050	12	
		Brikke 50_1T(4)	04-060-050	12	
		Torx M8x30 (4) Torx M8x25(4)	04-000-030 04-000-025	12 12	
		Skive M8 (8)	04-055-008	24	
		Låsemutter M8 (4)	04-040-008	12	

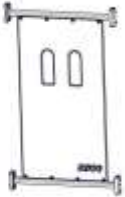















**Boltepakker for / Boltpackage for / Bultpaket för**

Sign. \_\_\_\_\_

<b>Rekkverk cc880 07-302-130 åpen</b>	<b>Ant= 3</b>	<b>Navne</b>	<b>Artnr/dimensjon</b>	<b>Ant</b>	<b>Lev</b>
		Sperrerør med lepp (2)	07-302-110	6	
		Vegg 655x610 cc880 (1) Åpen	07-302-130	3	
		Torx M8x12 (8) Torx M8x25 (8)	04-000-012 04-000-025	24 24	
		Møbelknapp 16x11 (8)	04-030-011	24	
		Brikke 120_3T(4)	04-060-120	12	
<b>Rekkverk cc880 07-302-102 høy vindo</b>	<b>Ant= 2</b>	<b>Navne</b>	<b>Artnr/dimensjon</b>	<b>Ant</b>	<b>Lev</b>
		Sperrerør med lepp (2)	07-302-110	4	
		Vegg 620x1150 cc880 (1) Med vindo	07-302-102	2	
		Torx M8x12 (8) Torx M8x25 (8)	04-000-012 04-000-025	16 16	
		Møbelknapp 16x11 (8)	04-030-011	16	
		Brikke 120_3T(4)	04-060-120	8	









**Boltepakker for / Boltpackage for / Bultpaket för**

Sign. \_\_\_\_\_

<b>Sitebenk CC880 07-520-608</b>	<b>Ant= 2</b>	<b>Navne</b>	<b>Artnr/dimensjon</b>	<b>Ant</b>	<b>Lev</b>
		Sitebenk cc880 (1)	07-520-608	2	
		Feste 45gr (2) 120x120x40x5	04-400-001	4	
		Vinkel 50x50x50x5 11mm hull (2)	04-070-050	4	
		Torx M8x12 (4) Torx M8x20 (4)	04-000-012 04-000-020	8 8	
		Møbelknapp 16x11 (4)	04-030-011	8	
		Brikke 50_1T(4)	04-060-050	8	
<b>Butikksdisk CC880 07-520-620</b>	<b>Ant= 1</b>	<b>Navne</b>	<b>Artnr/dimensjon</b>	<b>Ant</b>	<b>Lev</b>
		Butikksdisk cc880 (1)	07-520-620	1	
		Vinkel 50x50x50x5 11mm hull (2)	04-070-050	2	
		Torx M8x12 (2) Torx M8x20 (2)	04-000-012 04-000-020	2 2	
		Møbelknapp 16x11 (2)	04-030-011	2	
		Brikke 50_1T(4)	04-060-050	2	
		Skive M8	04-050-008	2	

**Boltepakker for / Boltpackage for / Bultpaket för**

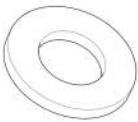
Sign. \_\_\_\_\_

6kant tak 07-500-600	Ant= 6	Navn	Artnr/dimensjon	Ant	Lev
		6kant tak (1)	07-500-600	6	
		Sperrørør 6kant tak	07-150-064	6	
		Fest U 6-kant tak	07-520-611	18	
		Møbelknapp (3) 16x11	04-030-011	18	
		Torx M8x45 (3)	04-000-045	18	
		Sekskant M8x35 Rustfritt	04-058-008	24	
		Skive rustfritt M8	04-058-008	24	
		Brikke 150 2xM8	04-060-151	12	

## Montering av lekeapparatet / Assembly instructions / Montering av lekredskapet

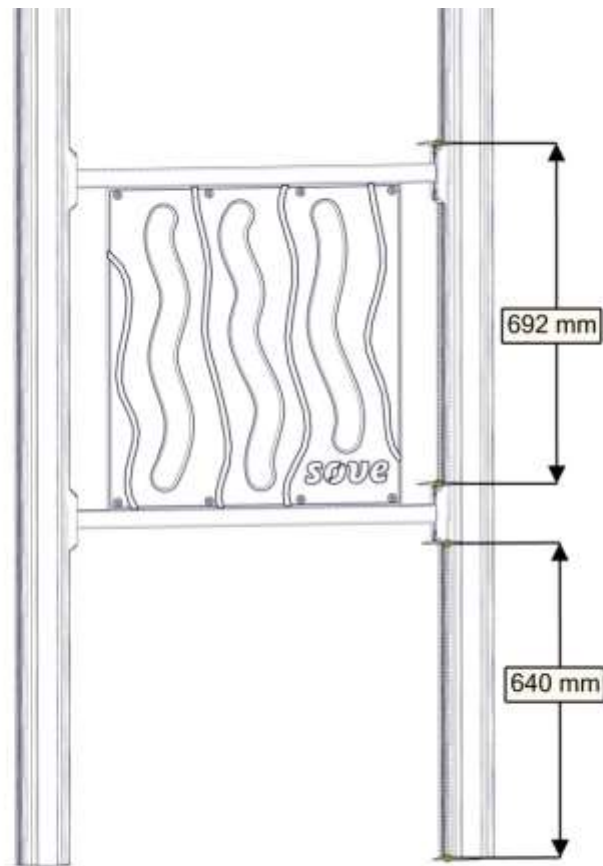

3x

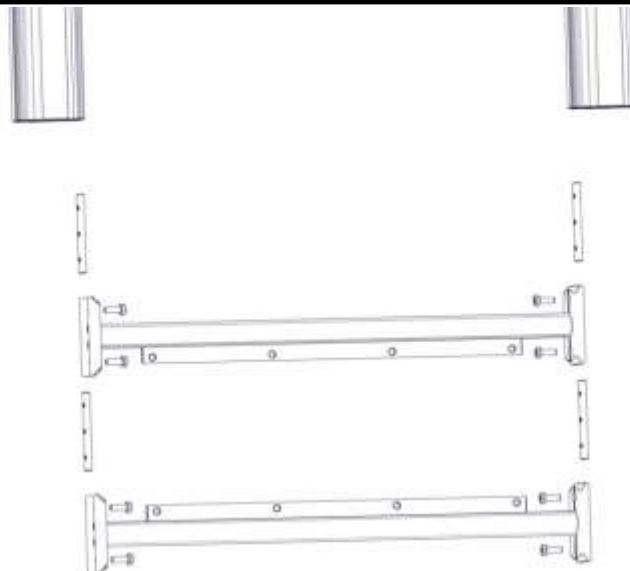

nr	PartName	Artnr	Antall
1	Stolpe 110 600-1900L=2500	07-100-324	2
4	Brikke 120 3xM8	04-060-120	4
2	Sperrerør med leppe cc880	07-500-066	2
3	Torx M8x25	04-000-025	8

3x

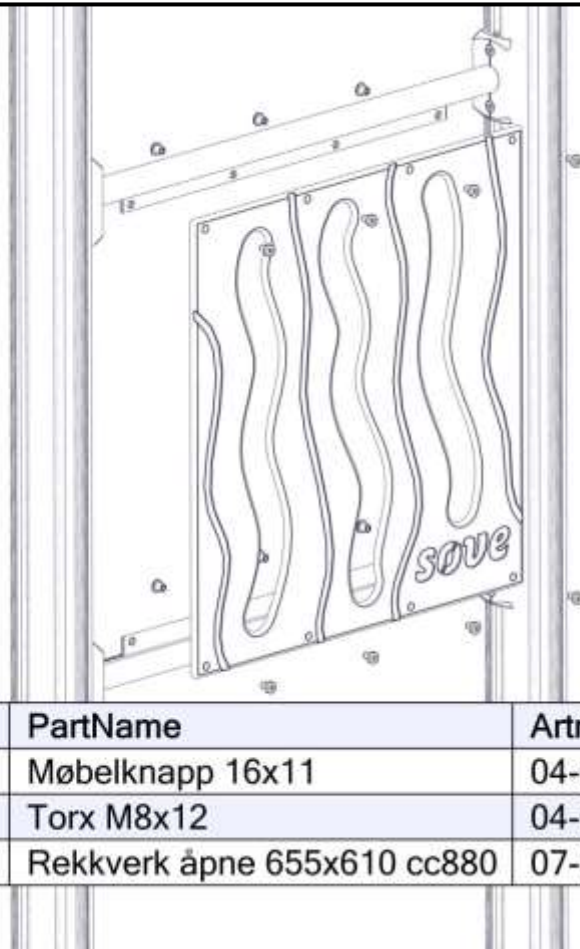

nr	PartName	Artnr	Antall
1	Møbelknapp 16x11	04-030-011	8
2	Torx M8x12	04-000-012	8
3	Rekkverk åpne 655x610 cc880	07-302-130	1

3x

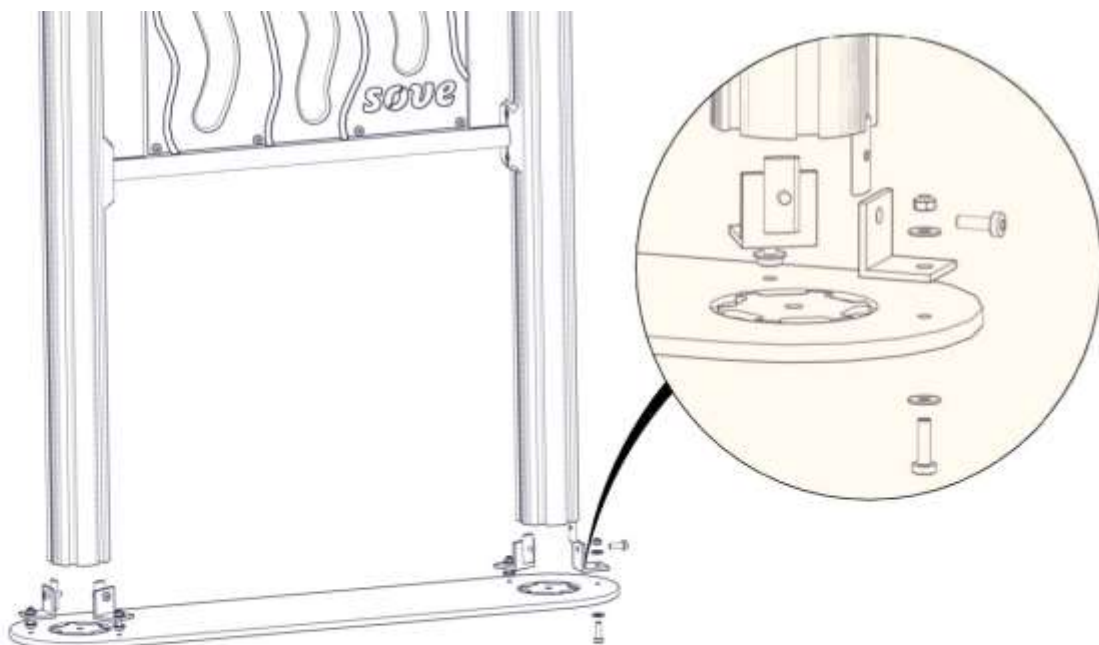

nr	PartName	Artnr	Antall
1	Torx M8x25	04-000-025	4
2	Torx M8x30	04-000-030	4
3	Låsemutter M8	04-040-008	4
4	Skive M8 stor	04-055-008	8

nr	PartName	Artnr	Antall
5	Brikke50 1XM8	04-060-050	4
6	Vinkel 50x50x50x5 11mm hull	04-070-050	4
7	Fundamentplate 2 stolper	07-400-012	1

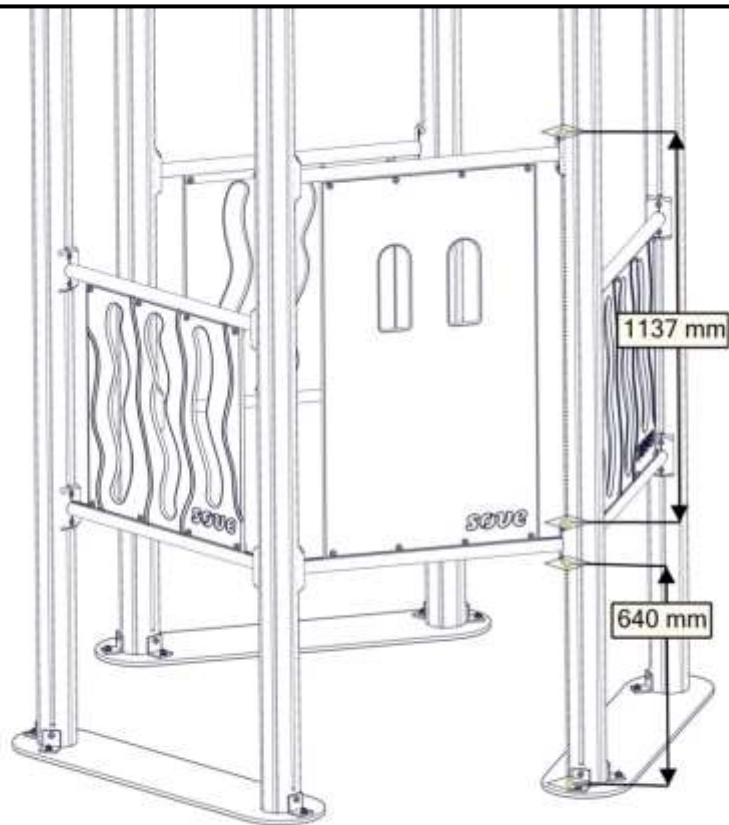

2x

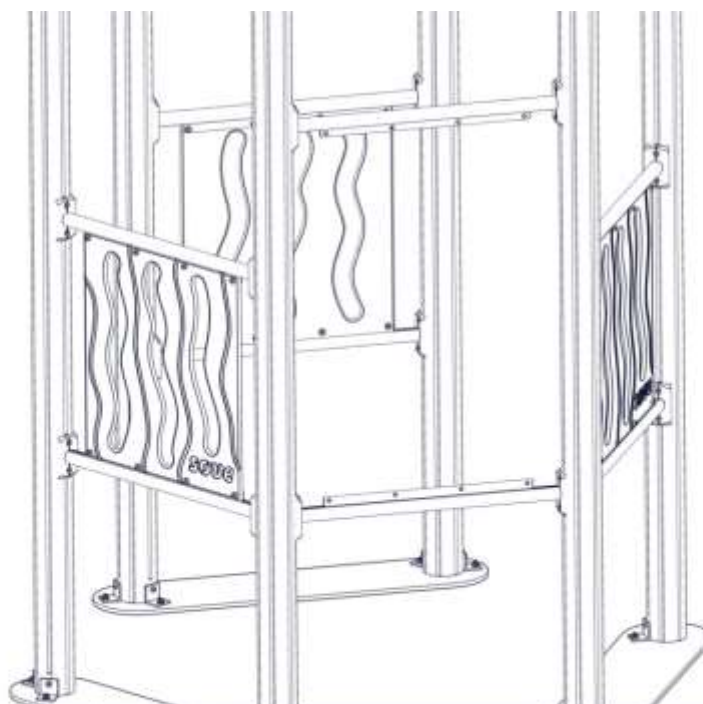

nr	PartName	Artnr	Antall
1	Torx M8x25	04-000-025	8
2	Brikke 120 3xM8	04-060-120	4
3	Sperrerør med leppe cc880	07-500-066	2

2x

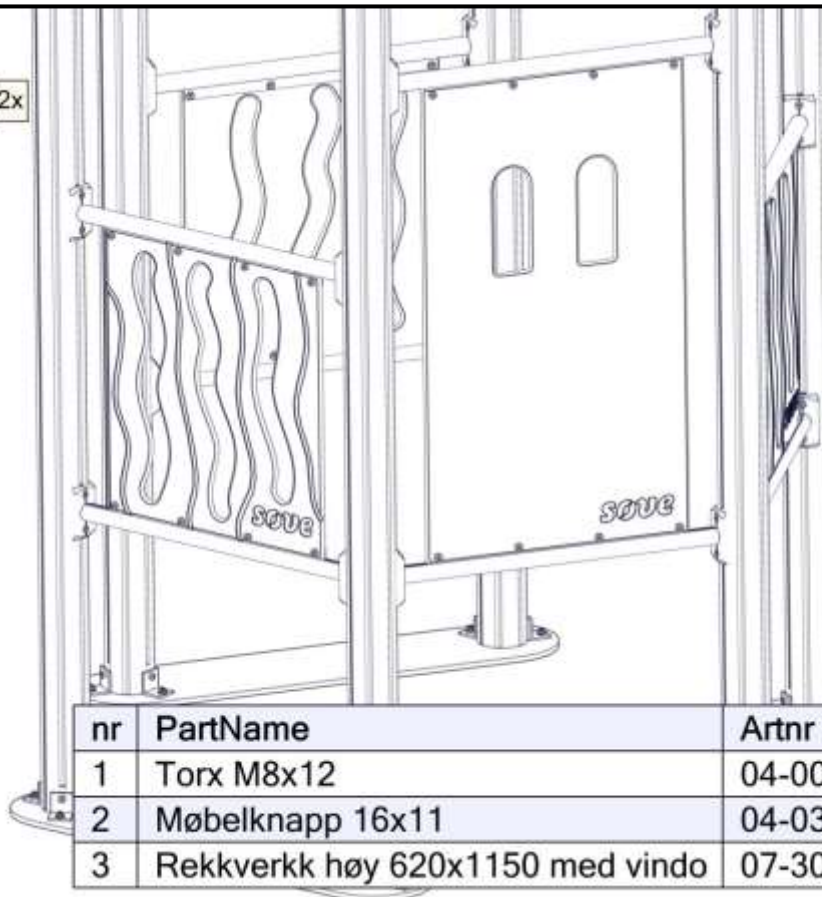

nr	PartName	Artnr	Antall
1	Torx M8x12	04-000-012	8
2	Møbelknapp 16x11	04-030-011	8
3	Rekkverkk høy 620x1150 med vindo	07-302-102	1

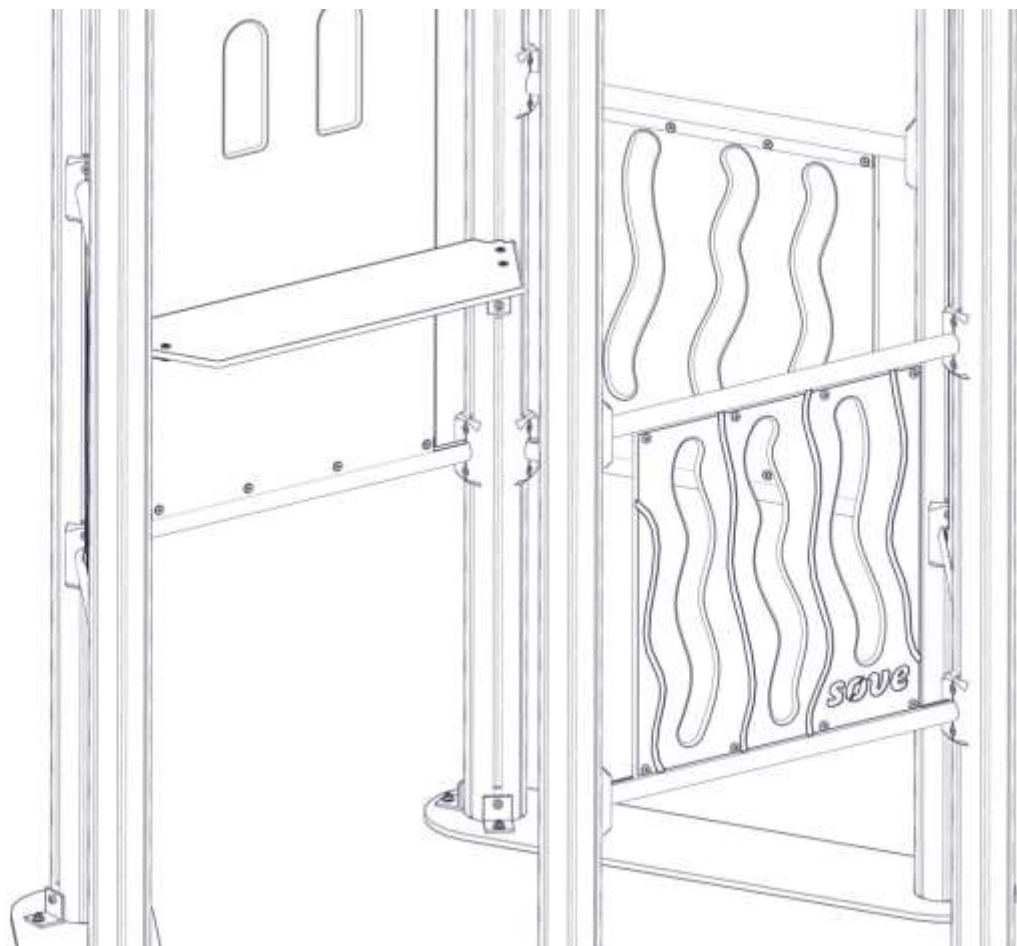

2x

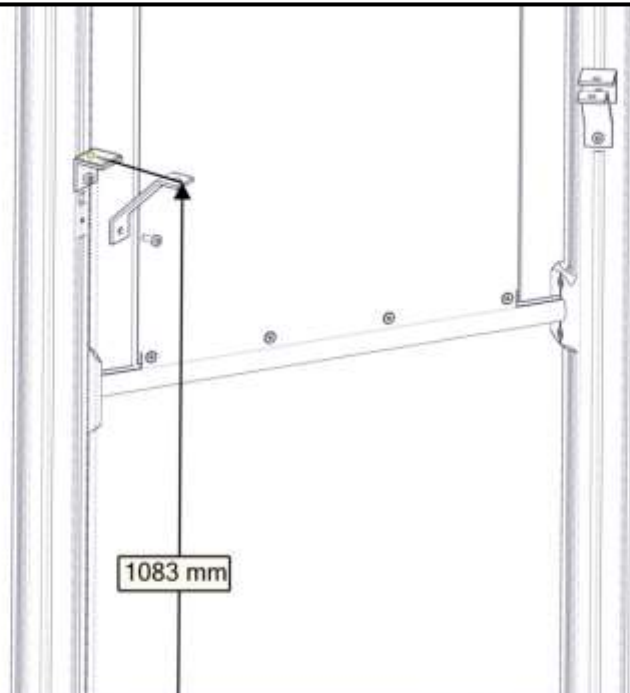

nr	PartName	Artnr	Antall
1	Torx M8x20	04-000-020	4
2	Brikke50 1XM8	04-060-050	4
3	Vinkel 50x50x50x5 11mm hull	04-070-050	2
4	Feste 45 gr 120x120x40x5	04-400-001	2

2x

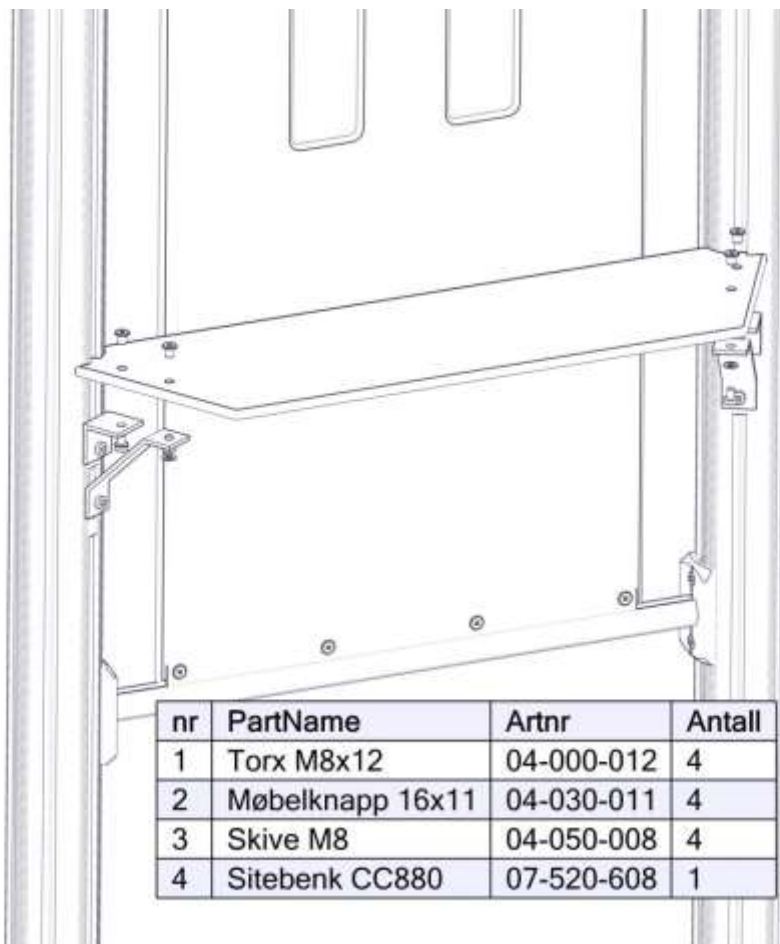



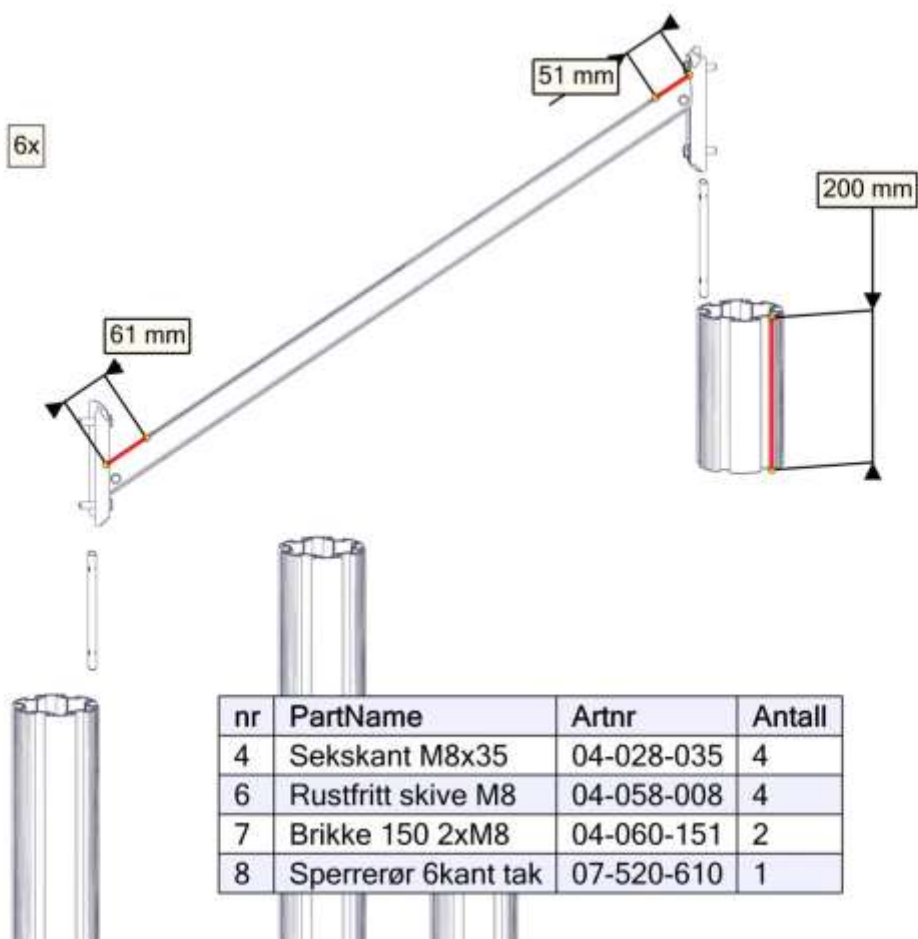
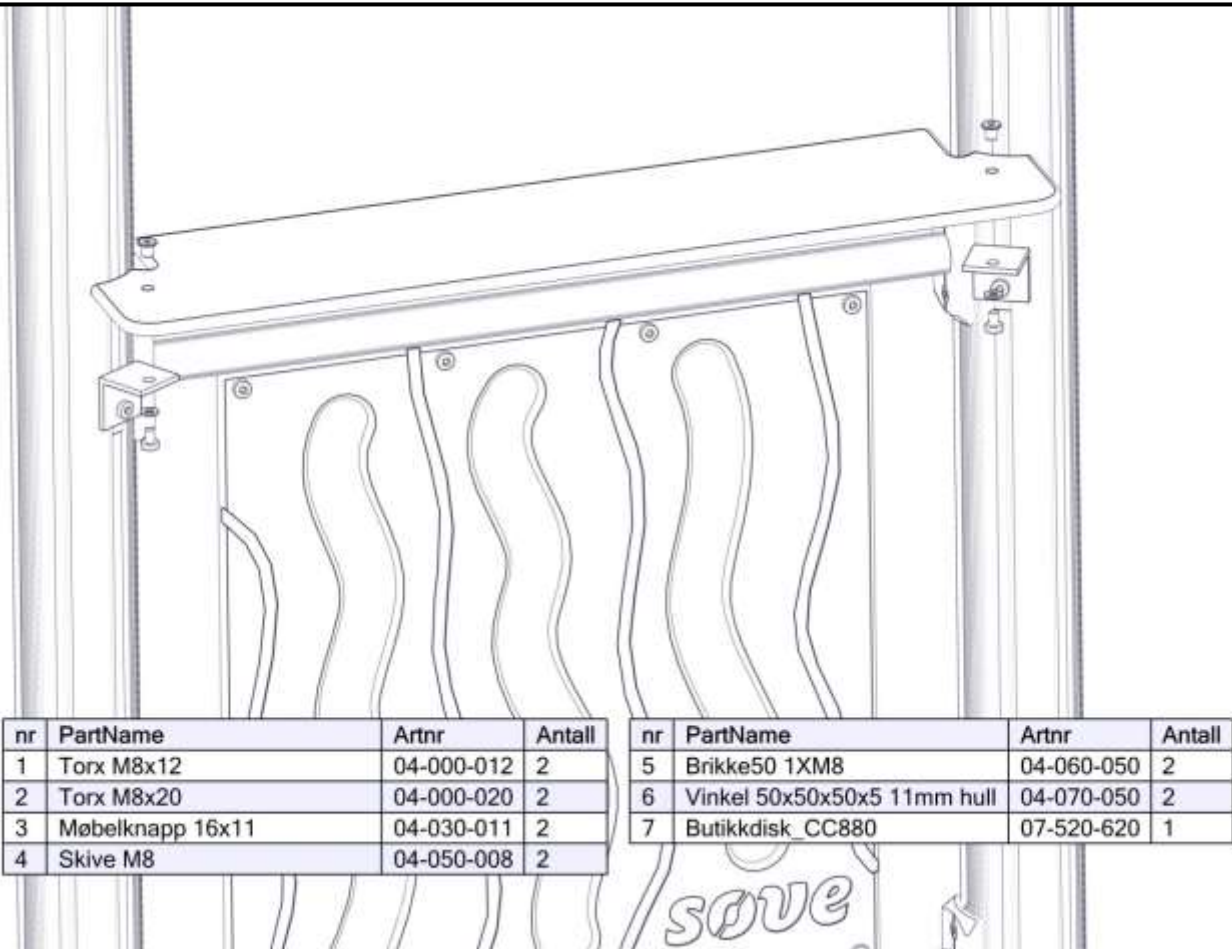

nr	PartName	Artnr	Antall
1	Torx M8x12	04-000-012	4
2	Møbelknapp 16x11	04-030-011	4
3	Skive M8	04-050-008	4
4	Sitebenk CC880	07-520-608	1

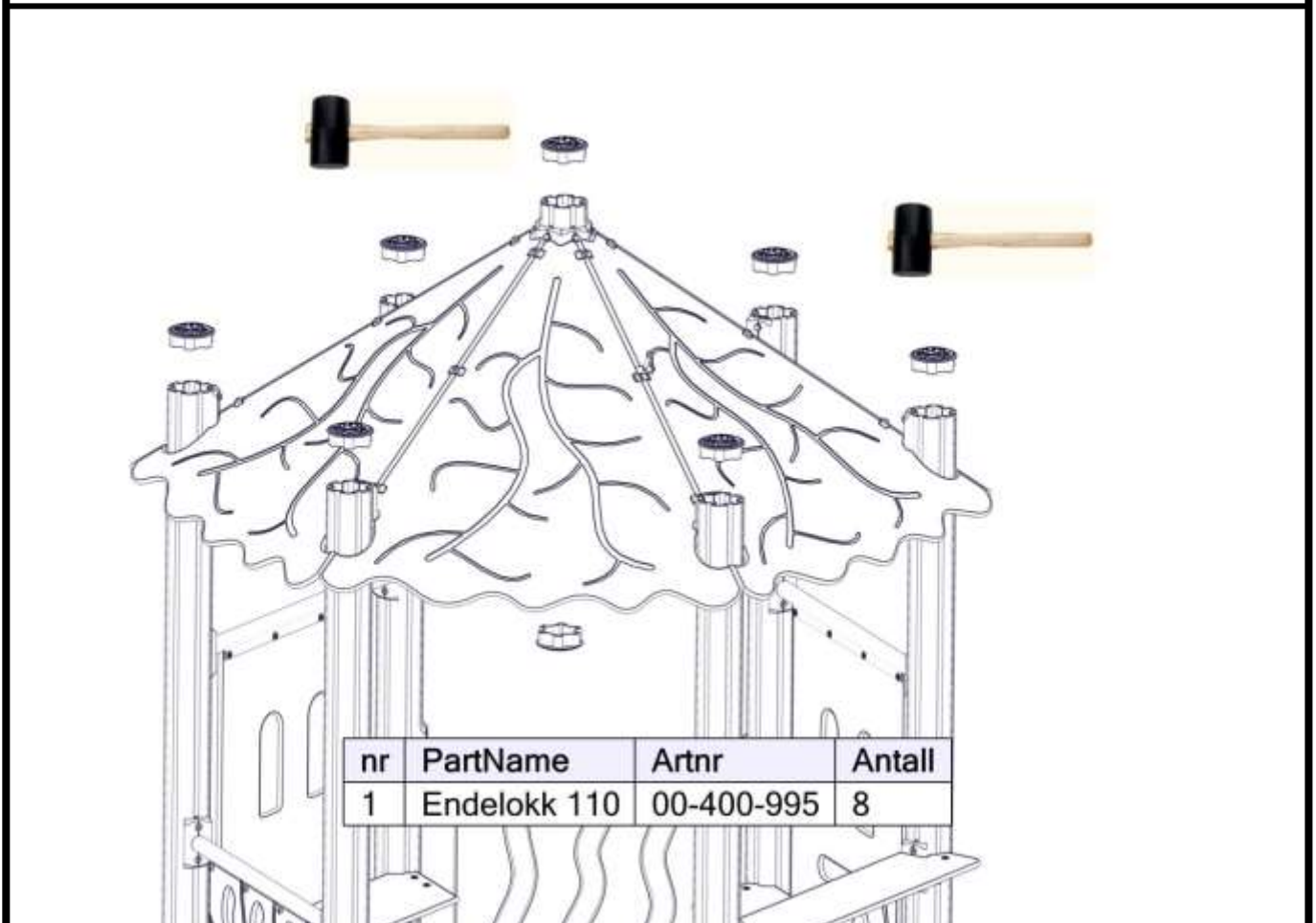
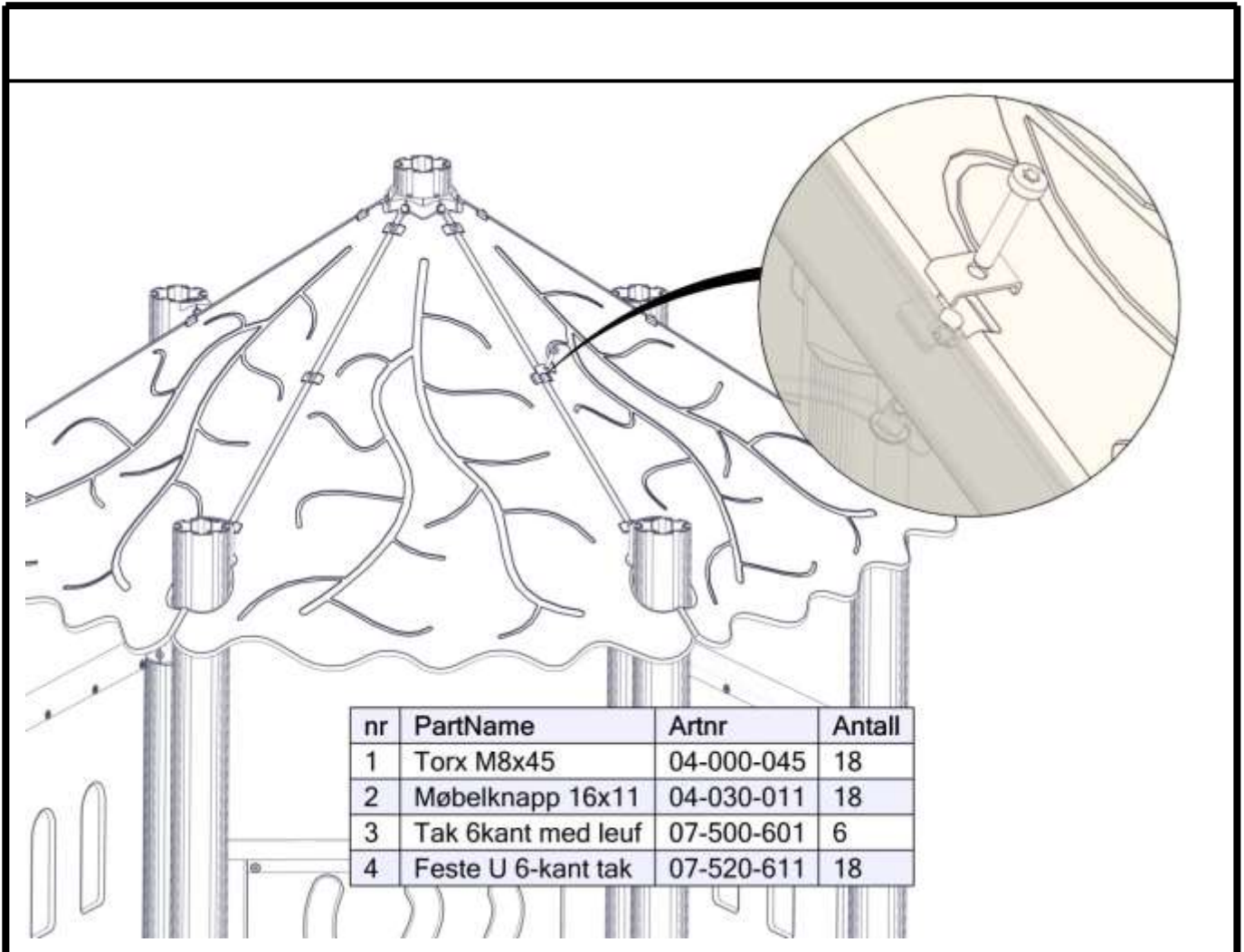



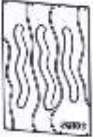







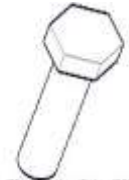

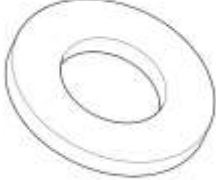

<b>Før utstyret tas i bruk / Before play begins / Innan lekredskapet tas i bruk</b>	
<b>N</b>	<ul style="list-style-type: none"> <li>● Påse at fallunderlag er utlagt i henhold til gjeldende regler eller vår anbefaling</li> <li>● Fjern alle monteringshjelpemidler ( rester av betong, planker, paller, plast, og lignende)</li> <li>● Før utstyret tas i bruk, burde man sjekke at det ikke er fare for at anorakksnorer og lignende som kan hekte seg fast noen steder på lekeapparatet. (Vedlagte snor med dobbe (kneledd) kan brukes til å sjekke at dette er i orden. Se vedlagte veiledning for bruk av denne. Dette gjøres for å oppdage eventuelle feilmonteringer.?)</li> <li>● NB! Bor stå i 2-3 dager før bruk</li> </ul>
<b>EN</b>	<ul style="list-style-type: none"> <li>● Make sure the area and depth of safer surfacing are according to the current standard, or to the manufacturer's recommendation</li> <li>● Make sure all tools and surplus materials are removed before play begins</li> <li>● PS! When complete, allow 2-3 days for the concrete to set before use</li> </ul>
<b>S</b>	<ul style="list-style-type: none"> <li>● Kontrollera att fallunderlag är utlagt enligt gällande regler eller vårt rekommendation</li> <li>● Ta bort alla monteringshjälpmedel (rester av betong, plankor, pallar, plast och liknande)</li> <li>● Innan lekredskapet används, kontrollera att anoracksnoddar eller kläder/delar av kläder eller liknande inte kan fastna i några delar på redskapet. (Den bipackade "knävringen" kan man med fördel användas för denna kontroll.</li> <li>● Detta görs för att upptäcka eventuella felmonteringar.)</li> </ul>

<b>komponenter</b>		Sign. _____
	Dobbel funda- ment <b>3</b> 07-400-002	Sperrerør med leppe <b>10</b> 07-302-110
	Vegg 655x610 <b>3</b> Cc880 åpen 07-302-130	Vegg 620x1150 <b>2</b> Cc880 m vindo 07-302-102
	Sitebank <b>2</b> 07-520-608	Butikkdisk <b>1</b> 07-520-620
	6kant tak <b>6</b> 07-500-600	Sperrerør 6kant tak <b>6</b> 07-150-064
	Feste U 6-kant <b>18</b> tak 07520-611	

<b>komponenter</b>		Sign. _____				
	Torx M8x12 04-000-012	<b>50</b>		Brikke 50-1T 04-060-050	<b>22</b>	
	Torx M8x20 04-000-020	<b>10</b>		Brikke 120-3T 04-060-120	<b>20</b>	
	Torx M8x25 04-000-025	<b>52</b>		Brikke 150-2T 04-060-151	<b>13</b>	
	Torx M8x30 04-000-030	<b>12</b>		Sekskant M8x35 Rustfritt	<b>24</b>	
	Torx M8x35 04-000-035	<b>2</b>		04-058-008		
	Torx M8x45 04-000-045	<b>18</b>		Møbelknapp 04-030-011	<b>68</b>	
	Skive M8 04-050-008	<b>2</b>			Vinkel 50x50x50x5	<b>18</b>
	Skive M8 stor 04-055-008	<b>24</b>			04-070-050	
	Skive M8 rustfritt 04-058-008	<b>24</b>				
	Stolpe 110 L=2500 600- 1900	<b>6</b>		Endelokk 00-400-995	<b>8</b>	
	Stolpe 110 L=200	<b>1</b>				
	Produktmerke 07-500-500	<b>1</b>		Låsemutter M8 04-040-008	<b>12</b>	
				Feste 45gr 120x120x40x5	<b>4</b>	
				04-400-001		