

**N****Monteringsanvisning****EN****Assembly Instructions****S****Monteringsanvisning**

Produkt nr. / Product no. / Produkt nr.

**14-101-012****Grå / Grønn**

Ord. nr. \_\_\_\_\_

Dato. \_\_\_\_\_

Sign. \_\_\_\_\_

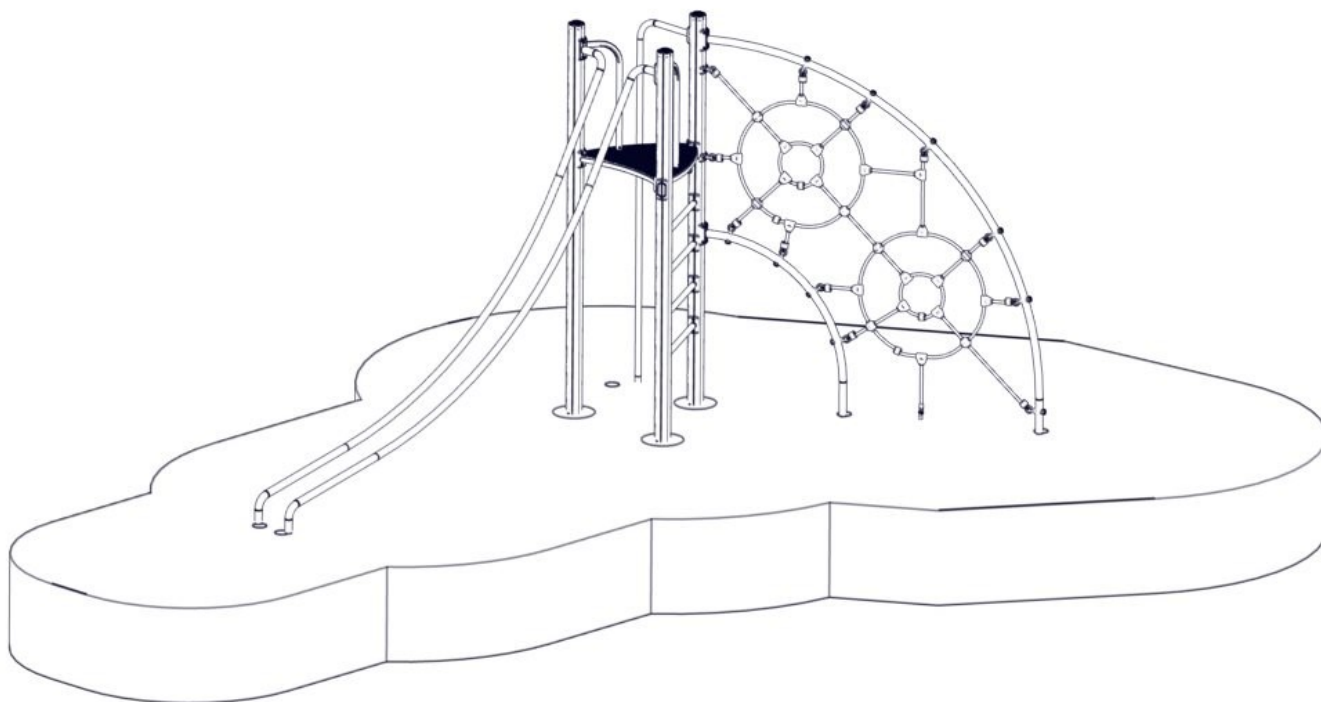
**søve**

Søve AS  
Grønnvoldveien 290  
3830 Ulefoss - Norway  
Tlf: +47 35 94 65 65  
[www.sove.no](http://www.sove.no)

**søve**

Søve AB  
EA Rosengrensgatan 32  
421 31 Västra Frölunda  
Phone: +46 (0)31 773 97 00  
[www.sove.se](http://www.sove.se)

## Monteringstips / Assembly Advice / Monteringsstips

N

- Les monteringsanvisningen nøye før montering.
- Monter elementene i rekkefølgen som vist.
- Boltene bør ikke skrues for hardt til før alt er montert, vatret og loddet. Skru så boltene til.
- NB! Ved bruk av drill, kan boltene ryke.
- På grunn av at solen kan gjøre rutsjeflaten veldig varm, bør rutsjebanens utløp vende mot nord-øst eller nord-vest.
- Er lekeutstyret plassert i naturlige ferdselstraséer må området sikres mot gjennomgang.
- Innspringningshinder bør vurderes rundt lekeapparater hvor det er stor bevegelse, f.eks. ved huskestativ.
- Det bør være fritt innsyn til lekeutstyr som er beregnet for barn under 3 år.

**NB! Under monteringsarbeidet må utstyr, som ikke er forankret forsvarlig i bakken, sikres slik at det ikke velte.**

**Området må avstenges under montering av apparatene med sperrebånd eller lignende.**

EN

- Read the instruction carefully before assembling the play unit.
- Assemble the components in the sequence shown in these instructions. Fixings must not be fully tightened during assembly. Before casting the foundations, the structure must be level and plumb, at which point all fixings are tightened. PS! If use of drill, the bolts may be wrecked.
- Avoid positioning the slide facing due south because of overheating – ideal positions are facing north-east or north-west. Secure the construction-area to prevent people from walking through it.
- Consider installing barriers around play-equipment which gives rise to a lot of activity – i.e.swings.
- Ensure that clear vision is possible across the play area so that supervision is possible from any position, particularly where children under 3 years of age will be playing.

**NB! During assembly of the equipment, ensure that all structures are securely propped, especially when left overnight. Also ensure that equipment is supported**

**Monteringstips / Assembly Advice / Monteringsstips****S**

- Läs monteringsanvisningen noga före montering.

- Montera delarna i den ordningen som anvisas
- Skruvarna bör inte skruvas för hårt tills allt är monterat, i våg och lodat.









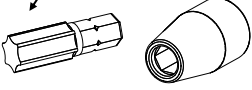

OBS! Används elektrisk skruvdragare, kan bulten gå sönder. Hårdra därför manuellt!

- Solen kan göra att rutchbanan blir väldigt varm. Banans nedfart rekommenderas att vändas i norrlig riktning
- Om lekplatsen placeras vid en gångväg mm bör området säkras mot genomfart av gående och cyklister.
- Insprängningshinder bör placeras runt lekutrustning med stor rörelse, t ex, gungställning.
- Det bör vara fri insyn till lekutrustning beräknat till barn under 3 år.

**OBS! Under monteringsarbete bör utrustningen som inte ska förankras i marken, ställs så att den inte kan välta.**

**Området måste spärras när lekutrustningen byggs upp, med avspärrningsband eller liknande.**

**Nødvendig verktøy / Tools required / Nödvändiga verktyg**

<p>(N)</p> <p>(EN)</p> <p>(S)</p>	<p>(A)</p> 	<p>(B)</p>  <p>Torx Nr 45</p> 	<p>(C)</p> <p>5 mm 6 mm</p> 	<p>(D)</p> 	<p>(E)</p> 
		<p>Metermål</p> <p>Metric measure</p> <p>Tumstock</p> 	<p>Ø11mm Bor</p> <p>Ø11mm Drill</p> <p>Ø11mm Borr</p> 	<p>Merkebånd</p> <p>Mark ribbon</p> <p>Märkeband</p> 	<p>13 + 17mm</p> 

**Nødvendig antall personer / Number of persons required / Rekommenderad antal personer**

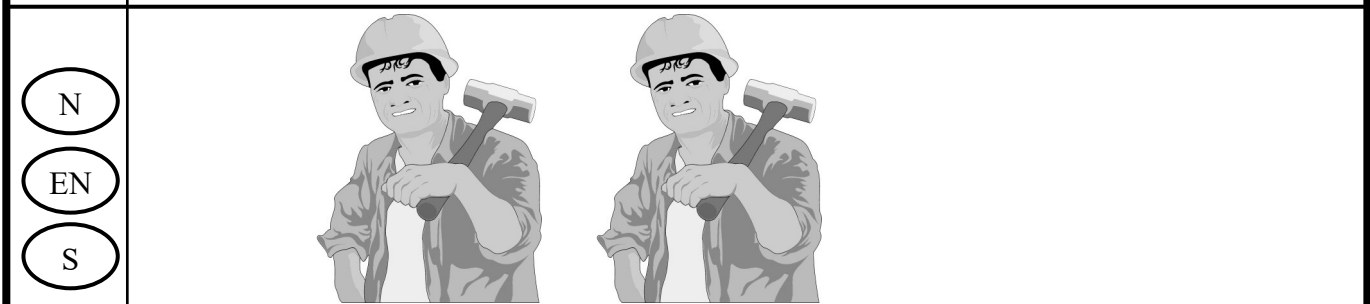



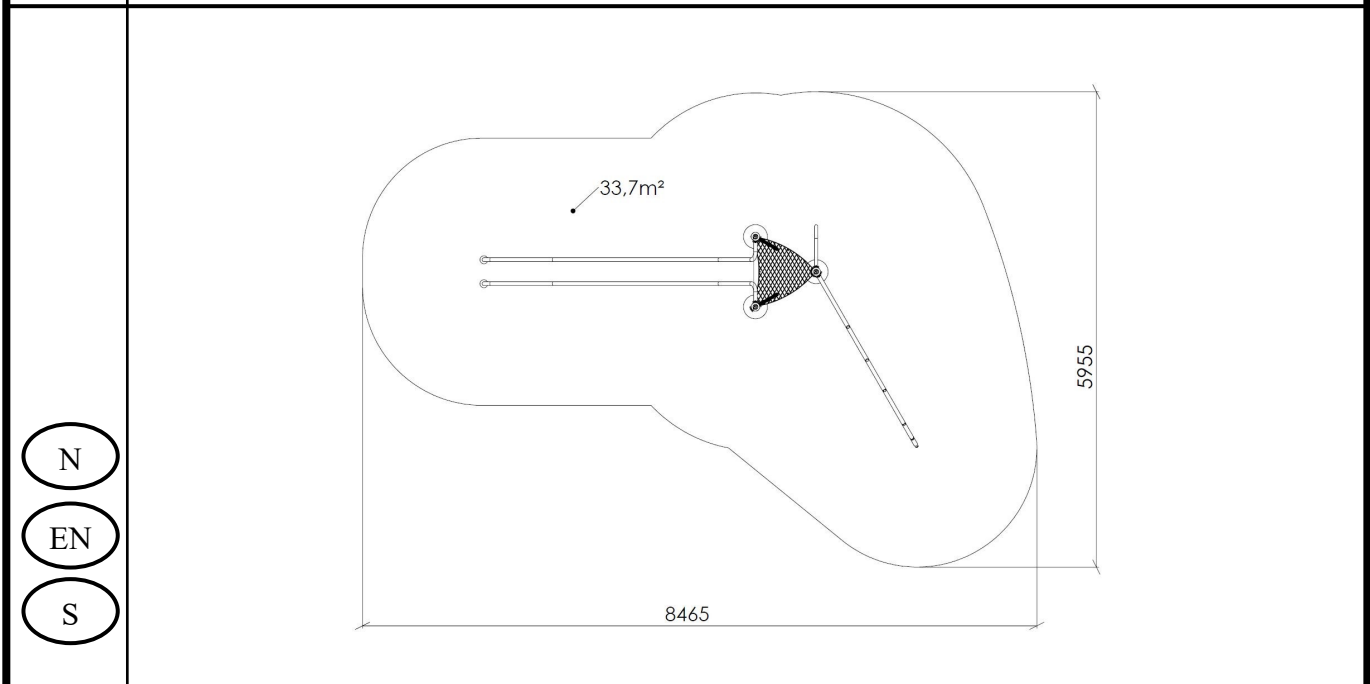

**Anbefalt arealbehov ved montering / Recommended working space / Rekommenderad arealbehov vid montering**



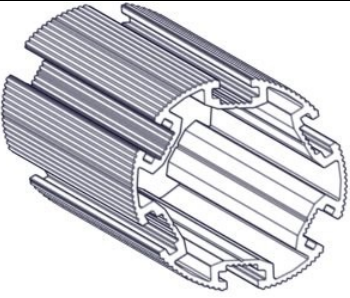
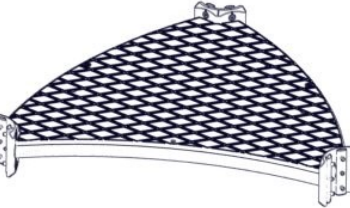

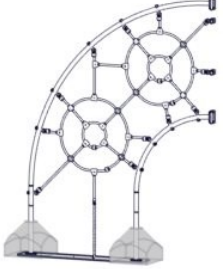

**Boltepakker for / Boltpackage for / Bultpaket för**

Sign. \_\_\_\_\_

Adventure Lifjell, Grå-grønn 14-101-012	Navn	Artnr/ dimensjon	Ant	Lev
	Stolpe Ø110 Lengde = 3450 (600-2850) Grå	SFA5126/2	3	
	Gulv 3-kant 1konkav 880 x 880 Grå	07-300-105K (se egen del- montering)	1	
	Sperrør rett uten hull L=750 Grønn	07-500-059K (se egen del- montering)	4	
	Sperrør rett uten hull L=750 Sort	07-500-075K (se egen del- montering)	2	
	Edderkoppnett dobbel komplett 30gr Grønn	07-500-028K (se egen del- montering)	1	
	Slider rør 2stk komplett	07-200-010K (se egen del- montering)	1	

**Boltepakker for / Boltpackage for / Bultpaket för**

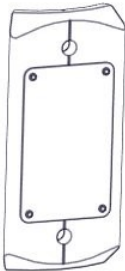
Sign. \_\_\_\_\_

Adventure Lifjell, Grå-grønn 14-101-012	Navn	Artnr/ dimensjon	Ant	Lev
	Brannstang gulv 1,9m komplett L=3000 Grå	07-200-037K (Se egen del- montering)	1	
	Sluse komplett H=790 Grønn	07-500-074K (Se egen del- montering)	2	
	Produktmerke	07-500-500	1	
	Endelokk 110	00-400-995	3	

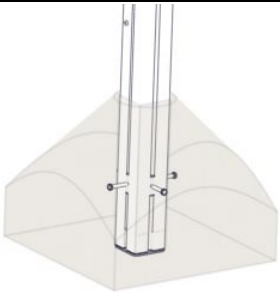
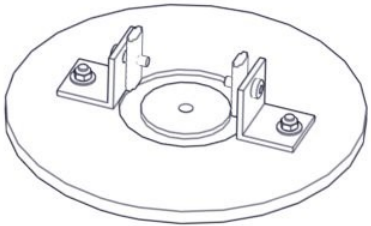
<b>Boltepakker for / Boltpackage for / Bultpaket för</b>		Sign. _____		
Adventure Lifjell, Grå-grønn 14-101-012	Navn	Artnr/ dimensjon	Ant	Lev
	<b>Fundament Støp</b>			
	Støpefundament stolpe Ø110	00-003-111K (se egen del- montering)	3	
	<b>Fundament Nedgravning</b>			
	Fundamentplate 1x110 stolpe Komplett	07-400-101K (se egen del- montering)	3	

**Fundamentering med betong // Foundation concrete // Förankring med betong**

- (N) Støtdempende materialer
- (EN) Impact attenuating materials
- (S) Støtdämpande material Ref NS-EN 1176-1 §4.2.8.5

- (N) Bakkenivå
- (EN) Ground level
- (S) Marknivå

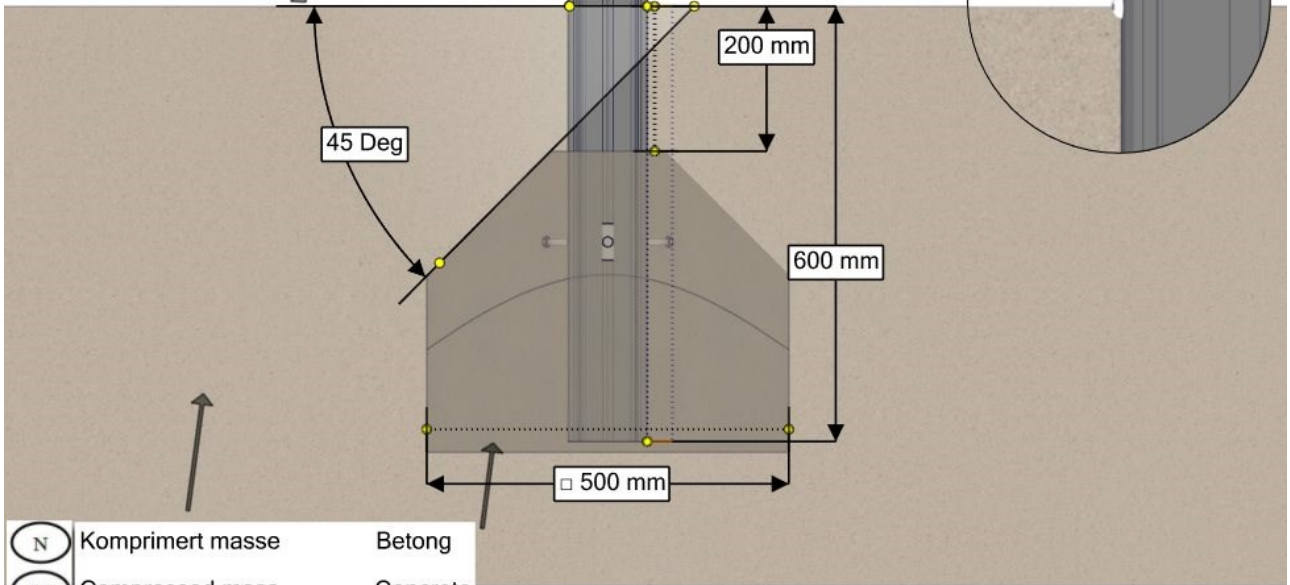

- (N) Komprimert masse Betong
- (EN) Compressed mass Concrete
- (S) Komprimerad massa Betong

**Fundamentering uten betong // Foundation without concrete // Förankring utan betong**

- (N) Støtdempende materialer
- (EN) Impact attenuating materials Ref NS-EN 1176-1 §4.2.8.5
- (S) Støtdämpande material

- (N) Bakkenivå
- (EN) Ground level
- (S) marknivå

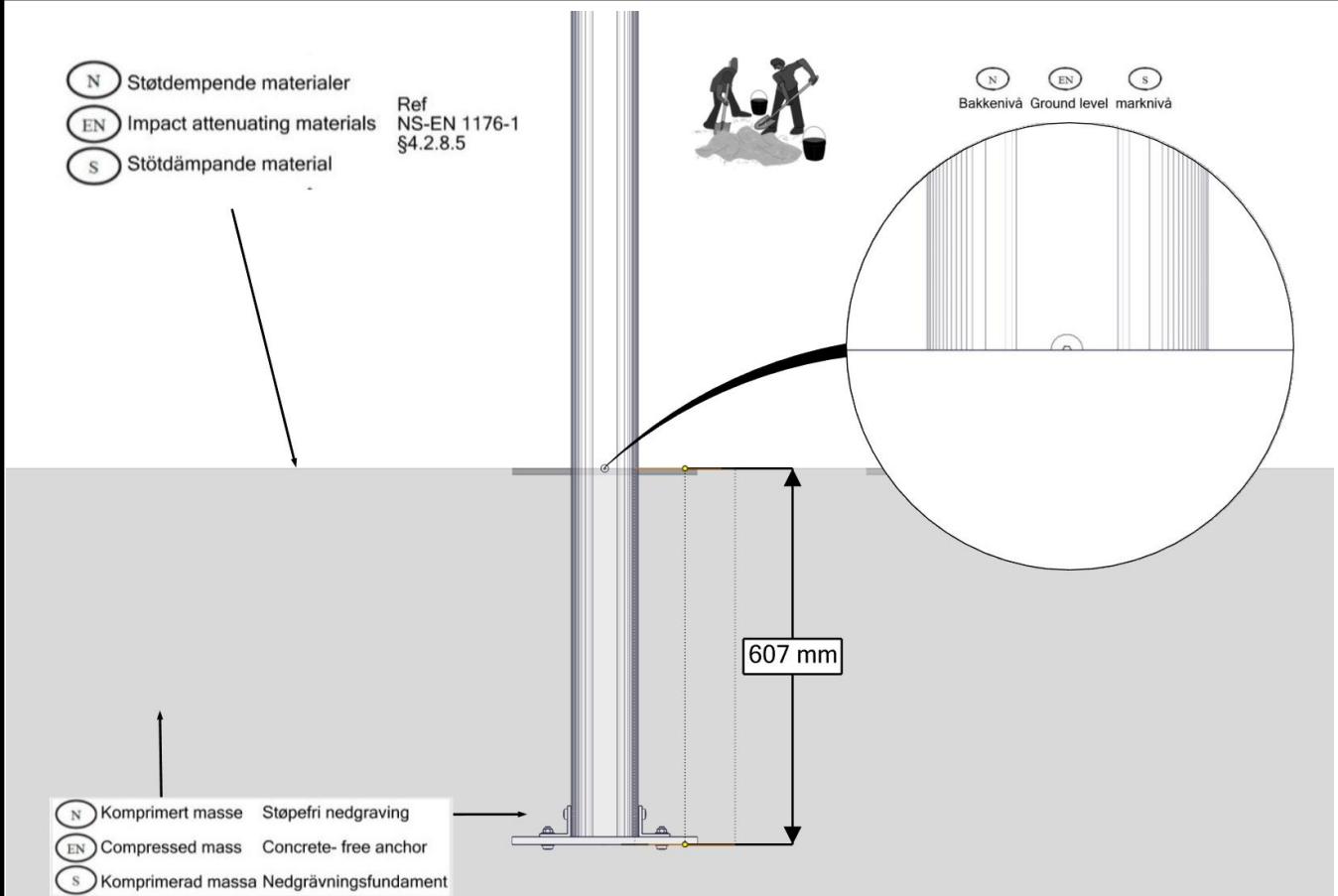

- (N) Komprimert masse Støpefri nedgraving
- (EN) Compressed mass Concrete-free anchor
- (S) Komprimerad massa Nedgravningsfundament



<b>Boltepakker for / Boltpackage for / Bultpaket för</b>		Sign. _____.		
Adventure Lifjell, Grå-grønn 14-101-012	Navn	Artnr/ dimensjon	Ant	Lev
	<b>Overflatemon- tering</b>			
	Fundament 3x110 stolpe for betongdekke	00-003-115K (Se egen del- montering)	1	
	Stolpe Ø110 må kappes Slider må kappes Edderkoppnett dobbel må kap- pes Brannstang må kappes	SFA5126/2 07-200-010 07-500-028 07-200-037		

**Fundamentering overflate / Foundation surface / Förankring grundytan**

Ref  
NS-EN 1176-1  
§4.2.8.5

N EN S  
Bakkenivå Ground level marknivå

Tykkelse/Thickness

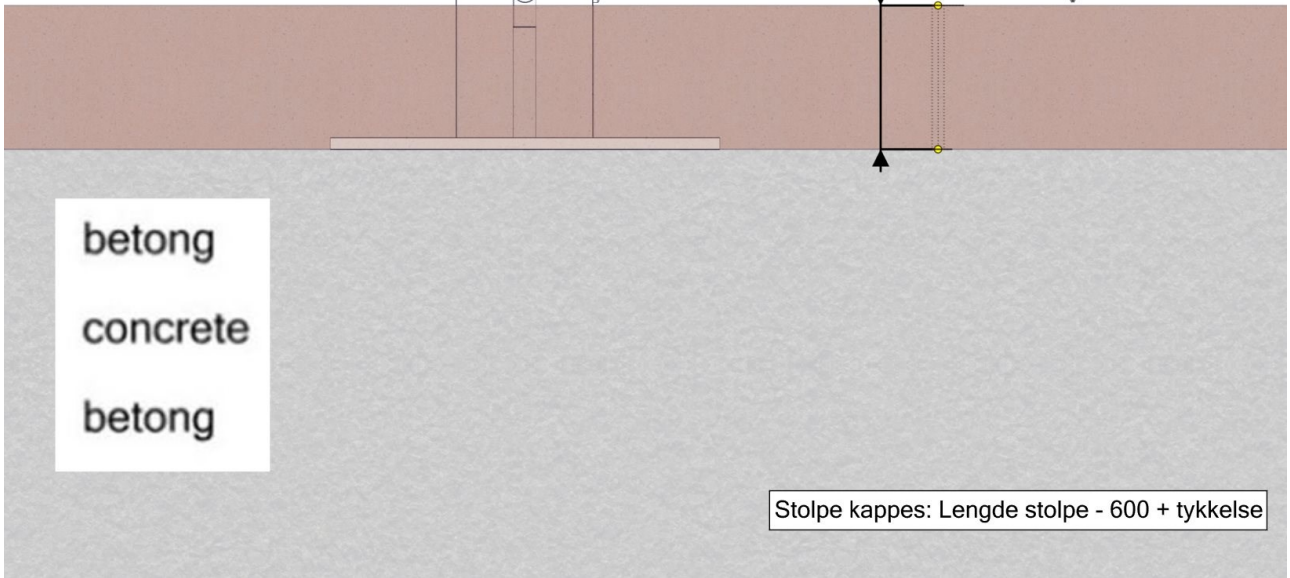

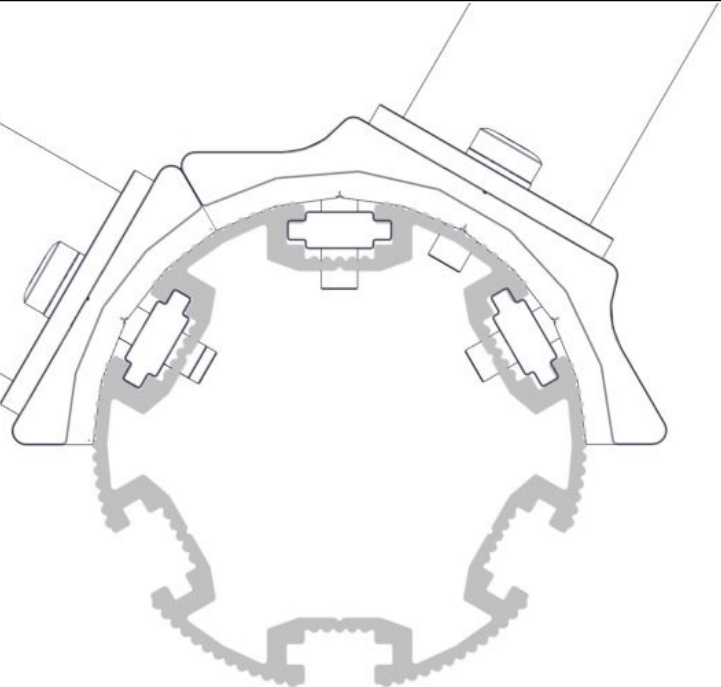

**N** Bolten skrues HELT igjennom aluminiumen.  
Maks dreiemoment: 30Nm

**EN** The bolt must be tightened in to the post, so that it peirces the aluminium  
Max torque: 30Nm

**S** Bulten skruvas HELT ignom aluminiumen.  
Maks vridmoment: 30Nm

NO	Betongkvalitet	C25/30		
SE	Betongkvalitet			
EN	Concrete quality			
NO	Mengde betong		0,5	m <sup>3</sup>
SE	Mängd betong			
EN	Amount of concrete			
NO	Fundament størrelse		0,5 x 0,5 x 0,4	m
SE	Stiftelsestorlek			
EN	Foundation size			
NO	For sikkerhet må fundamentene med sand eller myk jord være minst 50% større i areal			
SE	För säkerheten måste grunden med sand eller mjuk jord vara minst 50% större i området			
EN	For safety, the foundations with sand or soft soil must be at least 50% larger in area			
NO	Tyngste element	07-200-010 07-200-034 SFA5126/2	18 15,6 15,2	Kg
SE	Tyngsta element			
EN	Heaviest element			
NO	Største element	07-200-010 07-200-034 SFA5126/2	4,85x0,72x0,25 4,18x1,06x0,06 L=3,45 Ø=0,11	m
SE	Största element			
EN	Biggest element			

### Fallhøyder / Free height of fall / Fallhöjder

Fallhøyde = 2,7m

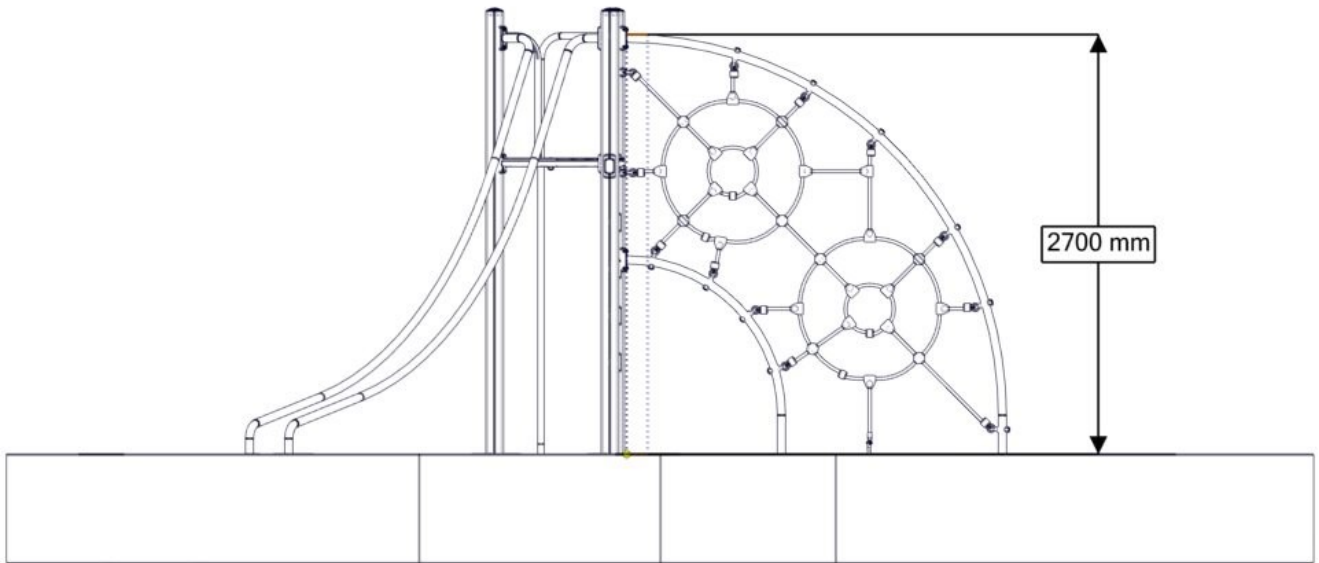

### Sikkerhetszone / Safety zone / Säkerhetszon

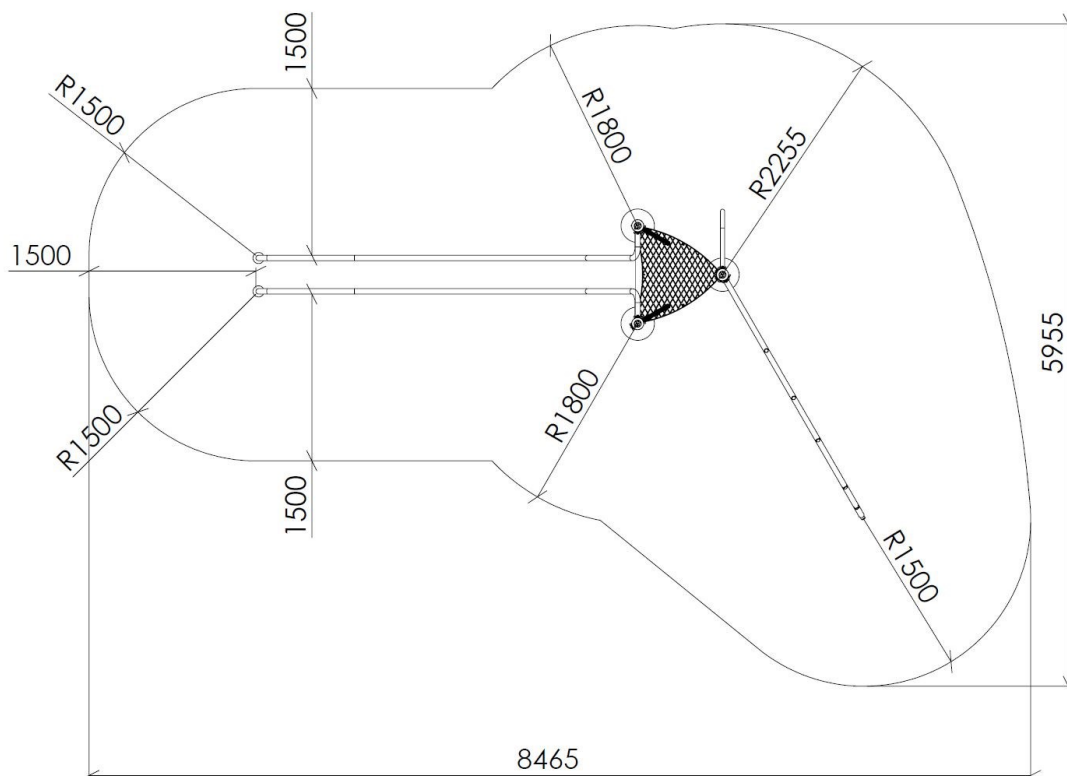

**Plassering av forankringer / Ground plan / Placering av förankringar**

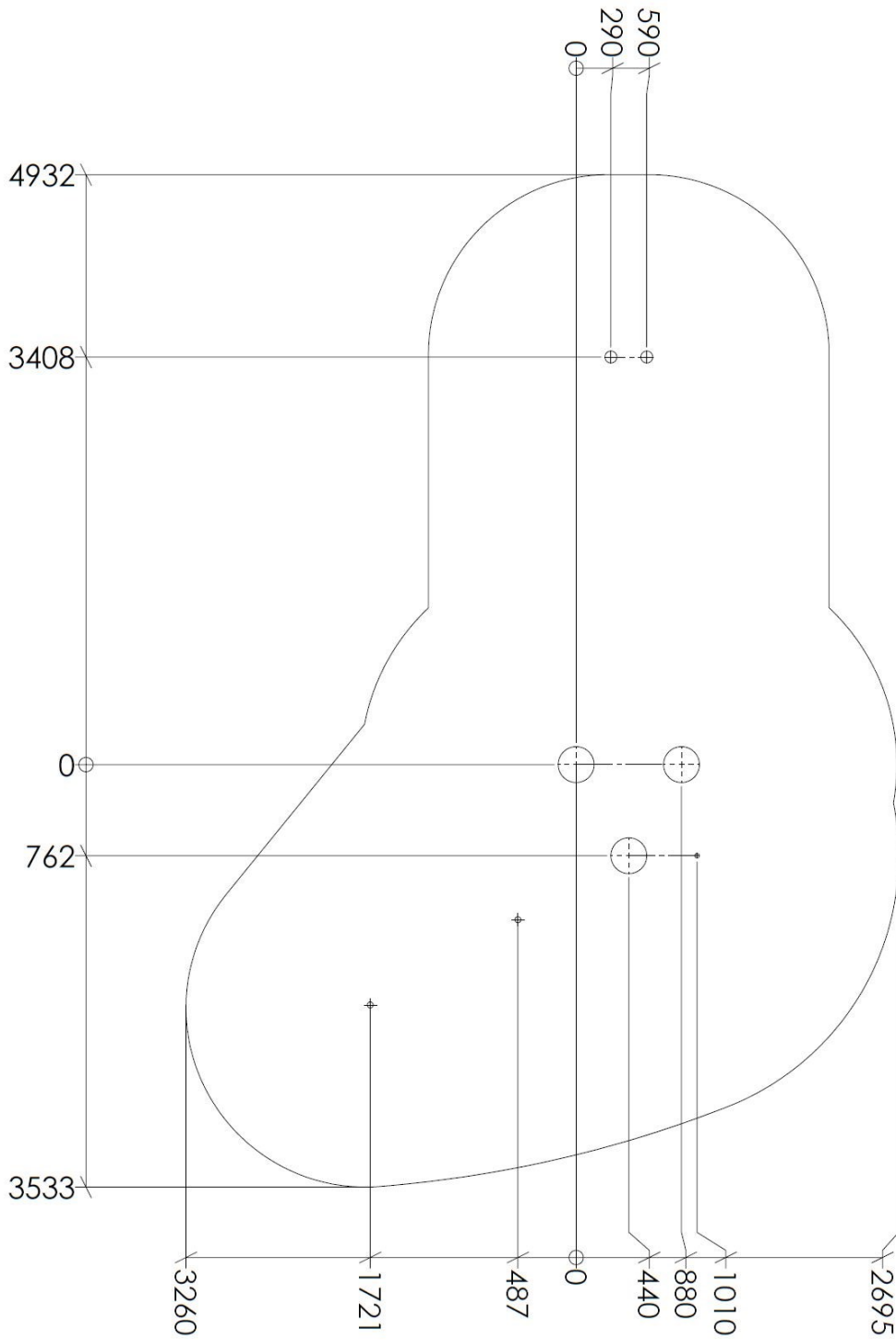

N

Alle mål er oppgitt i millimeter

EN

Scale measured in mm

S

Alla mått är i millimeter.

## Montering av lekeapparatet / Assembly instructions / Montering av lekredskapet

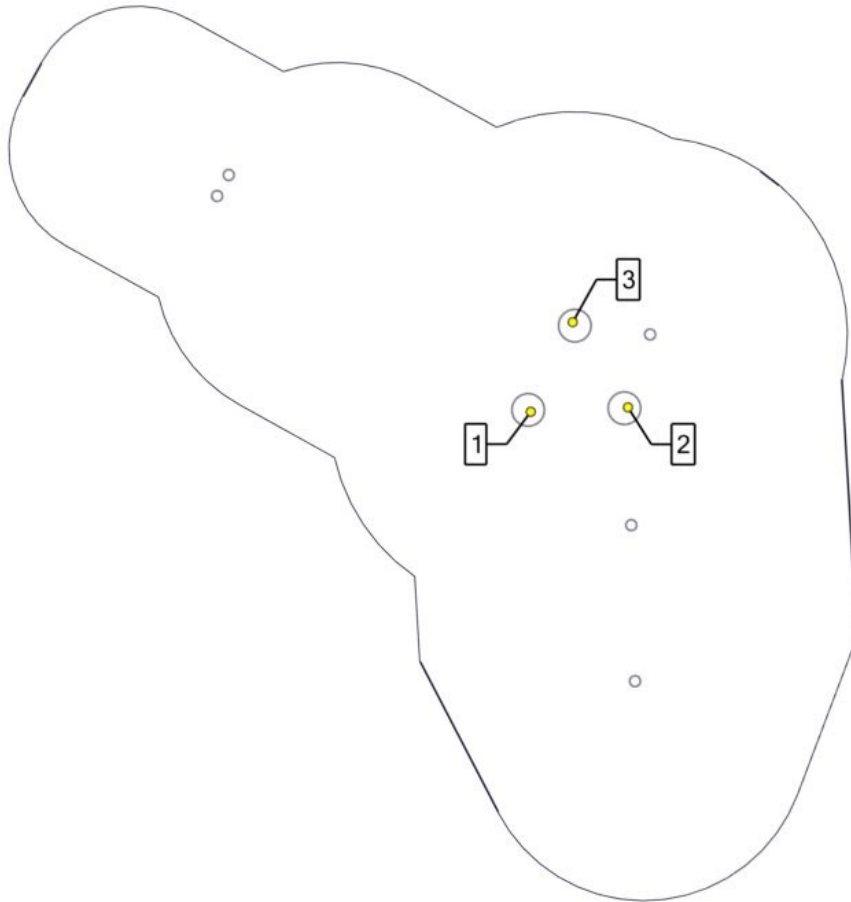

Se separat delmontering for detaljer  
See separate assembly for details  
Se separata delmontering för detaljer

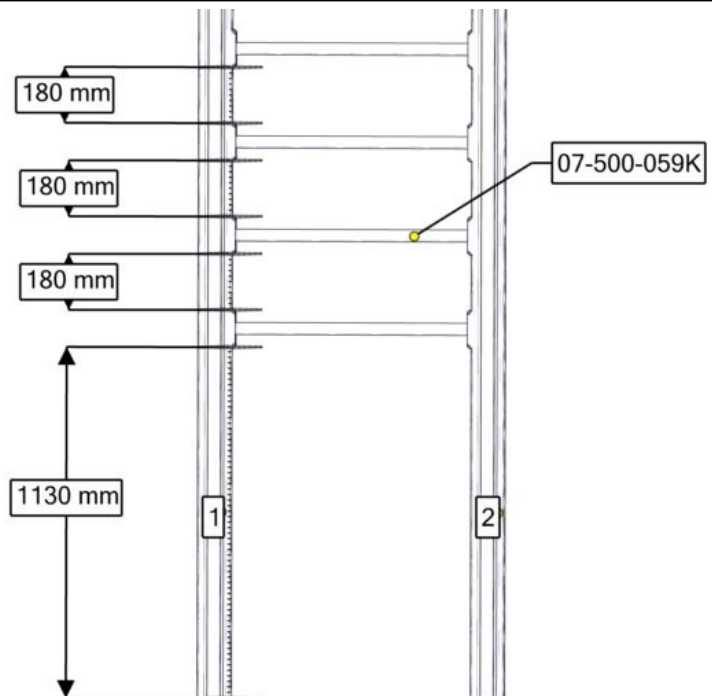

Part Name	Article nr.	Qty
Stolpe Ø110 L=3450 (600-2850)	SFA5126/2	1
Sperrerør rett L=750 uten hull komplett	07-500-059K	4

## Montering av lekeapparatet / Assembly instructions / Montering av lekredskapet

Se separat delmontering for detaljer  
 See separate assembly for details  
 Se separata delmontering för detaljer

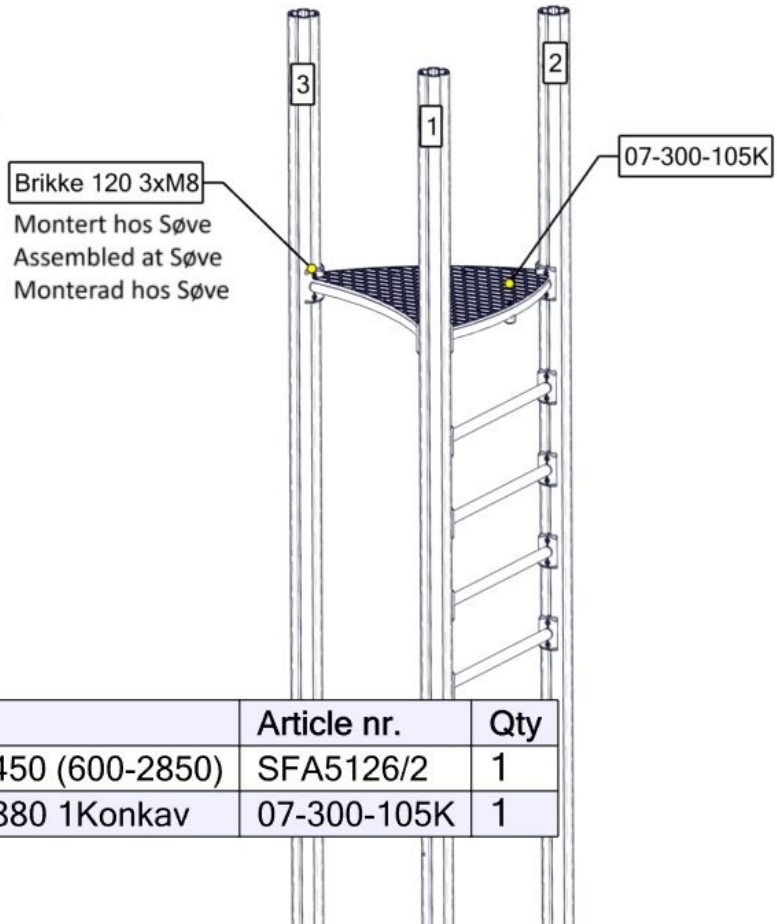

Part Name	Article nr.	Qty
Stolpe Ø110 L=3450 (600-2850)	SFA5126/2	1
Gulv 3-kant 880x880 1Konkav	07-300-105K	1

Se separat delmontering for detaljer  
 See separate assembly for details  
 Se separata delmontering för detaljer

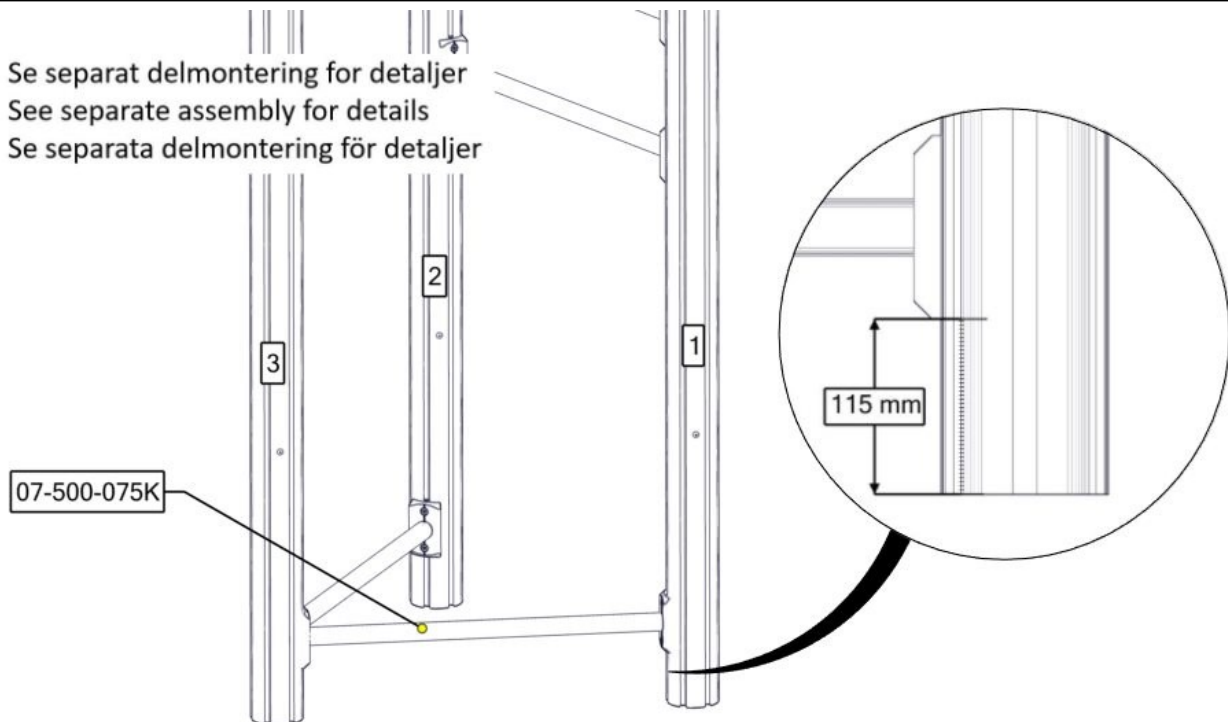

Part Name	Article nr.	Qty
Sperrerør rett L=750 uten hull	07-500-075K	2

## Montering av lekeapparatet / Assembly instructions / Montering av lekredskapet

Se separat delmontering for detaljer  
 See separate assembly for details  
 Se separata delmontering för detaljer

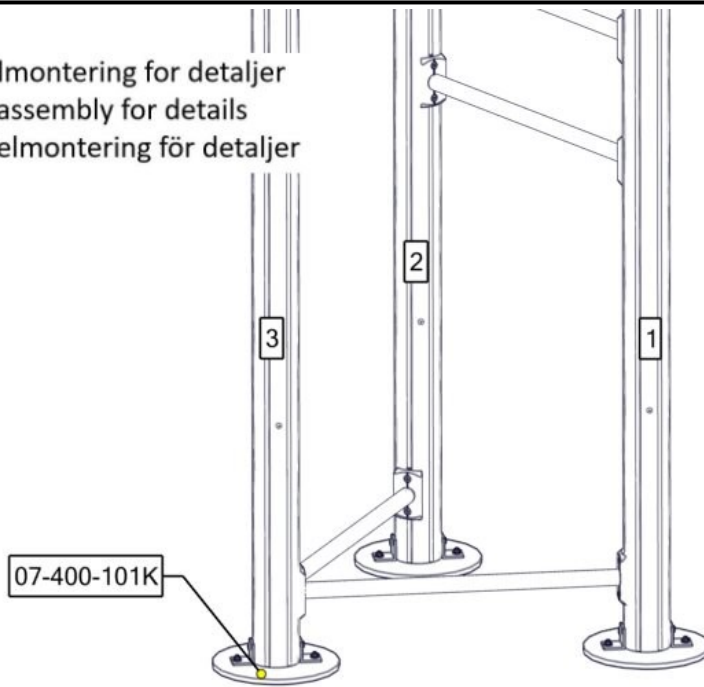

Part Name	Article nr.	Qty
Fundamentplate 1x110 stolpe komplett	07-400-101K	3

Se separat delmontering for detaljer  
 See separate assembly for details  
 Se separata delmontering för detaljer

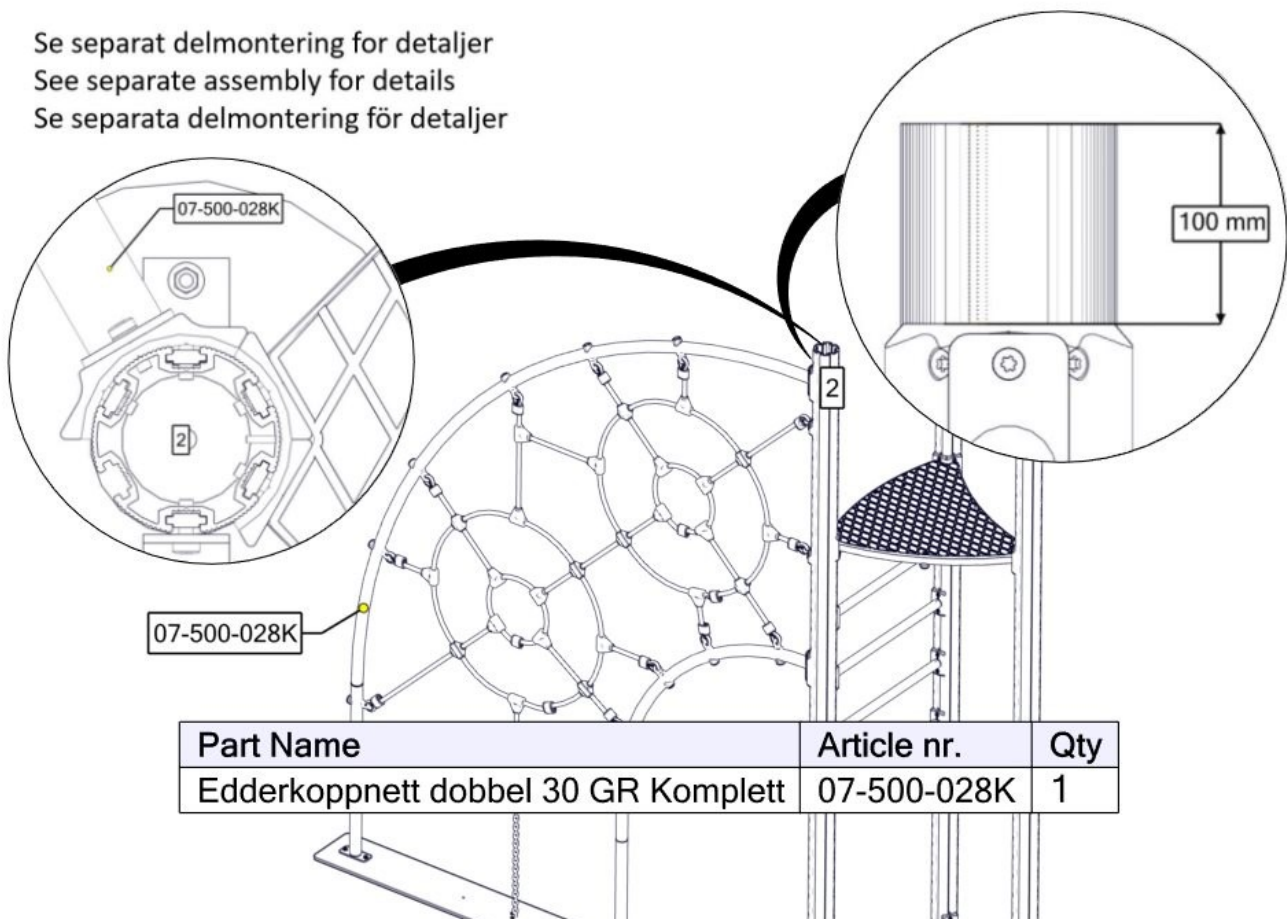

Part Name	Article nr.	Qty
Edderkoppnett dobbel 30 GR Komplett	07-500-028K	1



## Montering av lekeapparatet / Assembly instructions / Montering av lekredskapet

Se separat delmontering for detaljer  
 See separate assembly for details  
 Se separata delmontering för detaljer

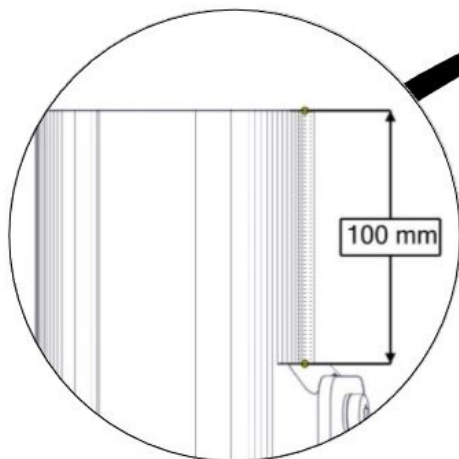

07-200-010K

Part Name	Article nr.	Qty
Slider rør 2 stk komplett	07-200-010K	1

Se separat delmontering for detaljer  
 See separate assembly for details  
 Se separata delmontering för detaljer

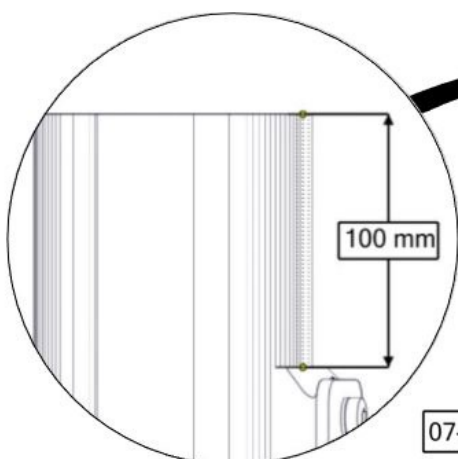

07-200-037K

07-200-037K

07-500-028K

Part Name	Article nr.	Qty
Brannstang gulv 1,9m L=3000 komplett	07-200-037K	1

**Montering av lekeapparatet / Assembly instructions / Montering av lekredskapet**

Se separat delmontering for detaljer  
 See separate assembly for details  
 Se separata delmontering för detaljer

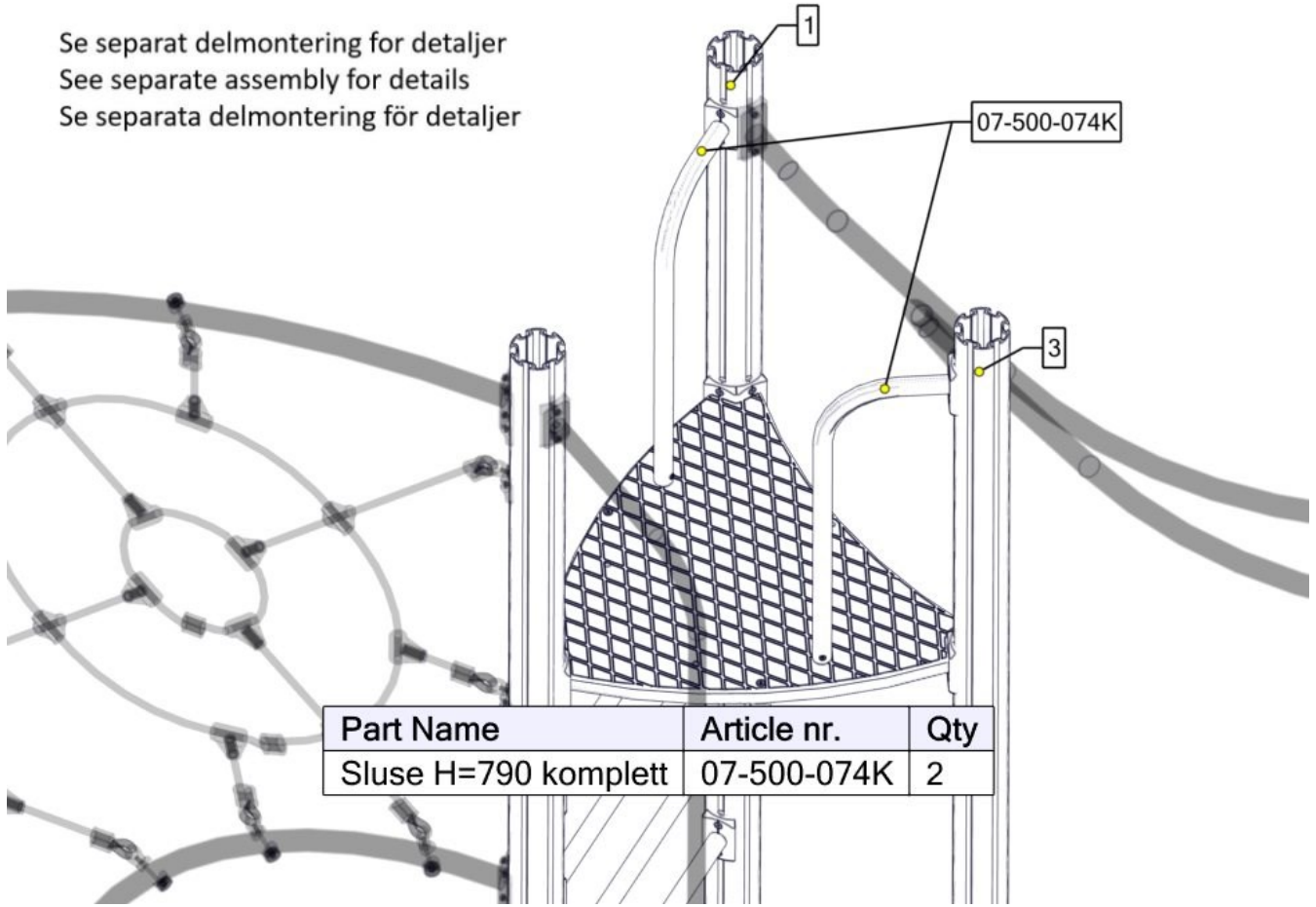

Part Name	Article nr.	Qty
Sluse H=790 komplett	07-500-074K	2

Se separat delmontering for detaljer  
 See separate assembly for details  
 Se separata delmontering för detaljer

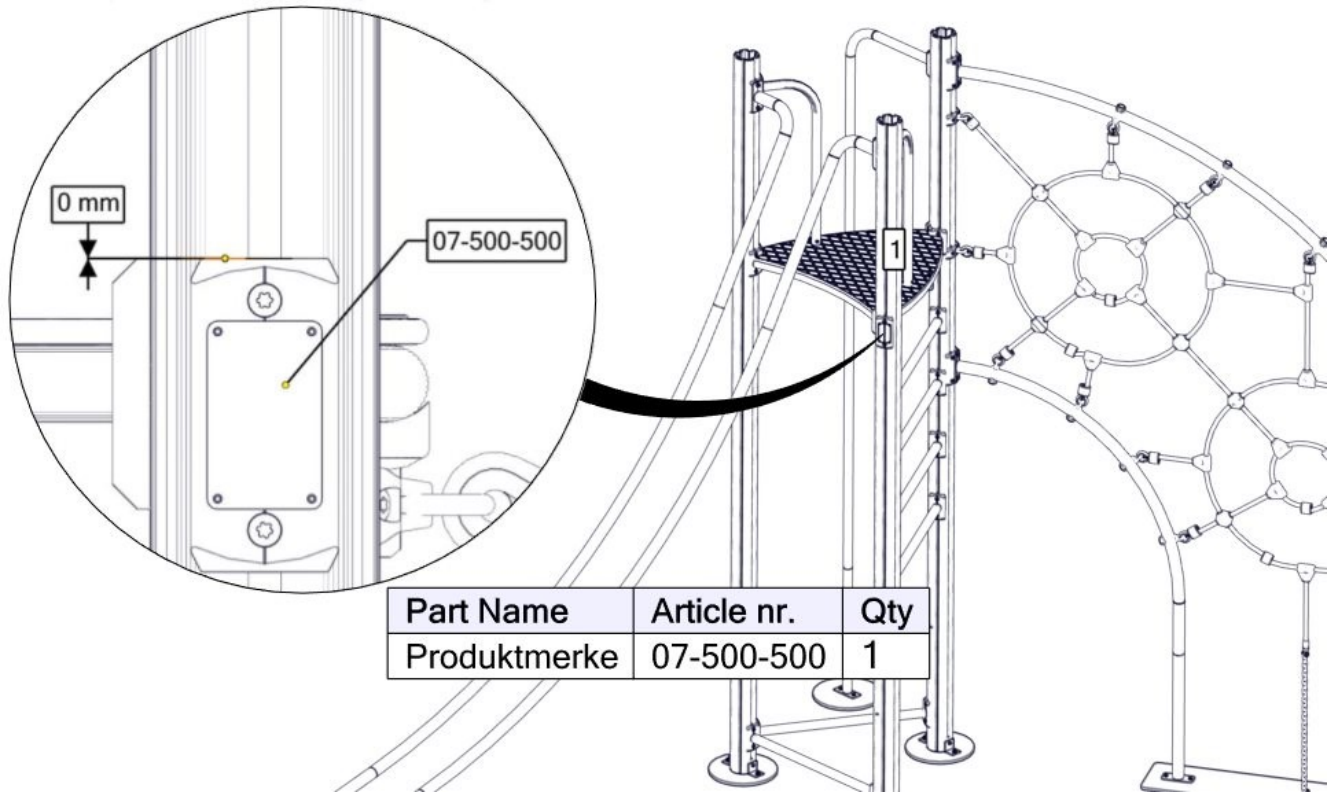





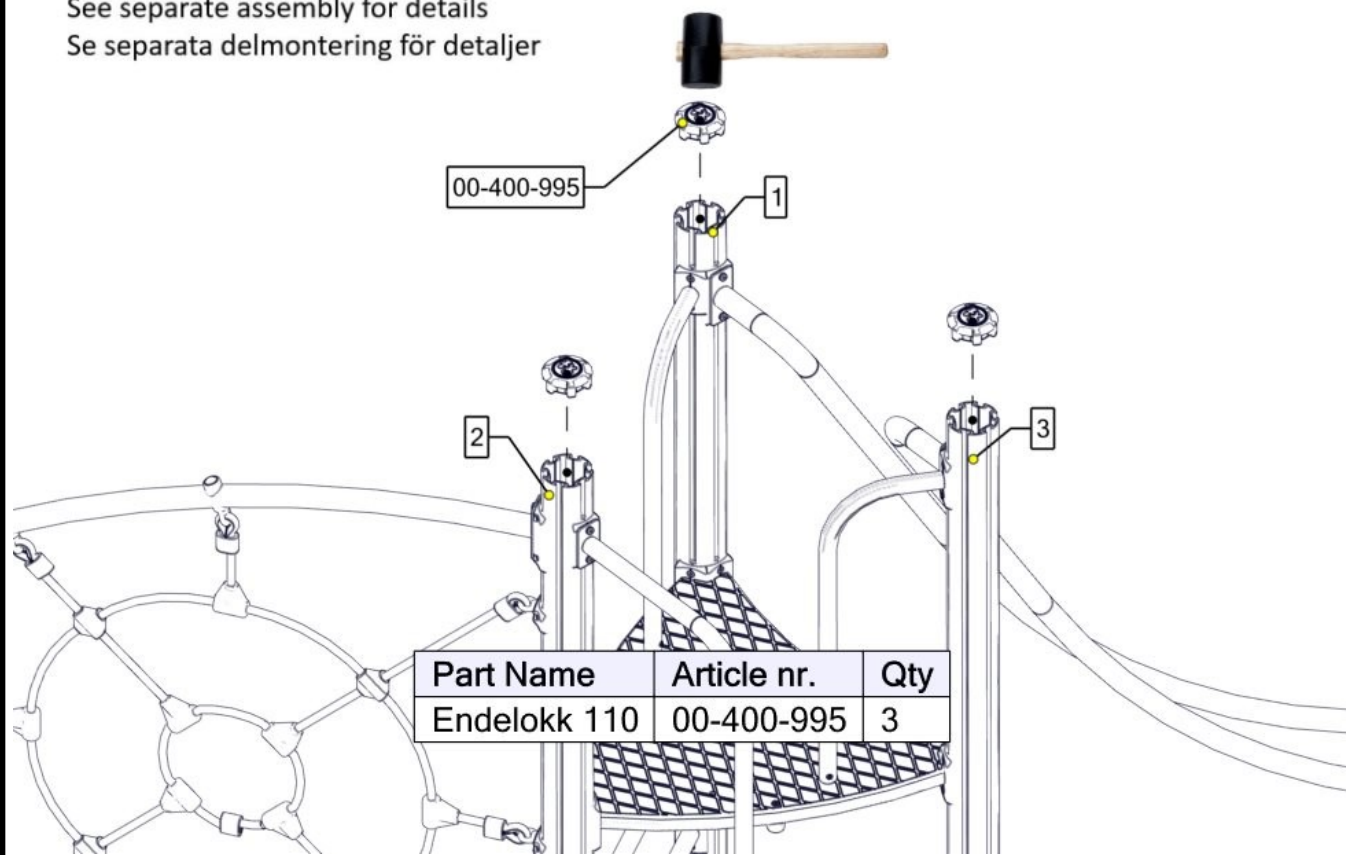

Part Name	Article nr.	Qty
Produktmerke	07-500-500	1

**Montering av lekeapparatet / Assembly instructions / Montering av lekredskapet**

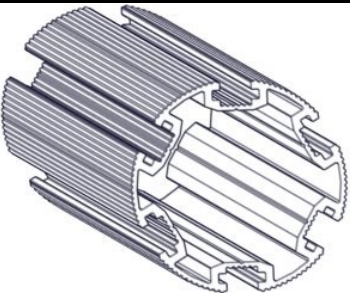
Se separat delmontering for detaljer  
See separate assembly for details  
Se separata delmontering för detaljer



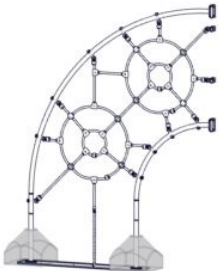



<b>Før utstyret tas i bruk / Before play begins / Innan lekredskapet tas i bruk</b>	
<b>N</b>	<ul style="list-style-type: none"> <li>● Påse at fallunderlag er utlagt i henhold til gjeldende regler eller vår anbefaling</li> <li>● Fjern alle monteringshjelpemidler ( rester av betong, planker, paller, plast, og lignende)</li> <li>● Før utstyret tas i bruk, burde man sjekke at det ikke er fare for at anorakksnorer og lignende som kan hekte seg fast noen steder på lekeapparatet. (Vedlagte snor med dobbe (kneledd) kan brukes til å sjekke at dette er i orden. Se vedlagte veiledning for bruk av denne. Dette gjøres for å oppdage eventuelle feilmonteringer.?)</li> <li>● NB! Bør stå i 2-3 dager før bruk</li> </ul>
<b>EN</b>	<ul style="list-style-type: none"> <li>● Make sure the area and depth of safer surfacing are according to the current standard, or to the manufacturer's recommendation</li> <li>● Make sure all tools and surplus materials are removed before play begins</li> <li>● PS! When complete, allow 2-3 days for the concrete to set before use</li> </ul>
<b>S</b>	<ul style="list-style-type: none"> <li>● Kontrollera att fallunderlag är utlagt enligt gällande regler eller vårt rekommendation</li> <li>● Ta bort alla monteringshjälpmedel (rester av betong, plankor, pallar, plast och liknande)</li> <li>● Innan lekredskapet används, kontrollera att anoracksnoddar eller kläder/delar av kläder eller liknande inte kan fastna i några delar på redskapet. (Den bipackade "knävringen" kan man med fördel användas för denna kontroll.</li> <li>● Detta görs för att upptäcka eventuella felmonteringar.)</li> </ul>

<b>Boltepakker for / Boltpackage for / Bultpaket för</b>		Sign. _____		
<b>Adventure Lifjell, Grå-grønn 14-101-012</b>	<b>Navn</b>	<b>Artnr/ dimensjon</b>	<b>Ant</b>	<b>Lev</b>
	Stolpe Ø110 Lengde = 3450 (600-2850) Grå	SFA5126/2	3	
	Gulv 3-kant 1konkav 880 x 880 Grå	07-300-105K (se egen del- montering)	1	
	Sperrør rett uten hull L=750 Grønn	07-500-059K (se egen del- montering)	4	
	Sperrør rett uten hull L=750 Sort	07-500-075K (se egen del- montering)	2	
	Edderkoppnett dobbel komplett 30gr Grønn	07-500-028K (se egen del- montering)	1	
	Slider rør 2stk komplett	07-200-010K (se egen del- montering)	1	

**Boltepakker for / Boltpackage for / Bultpaket för**

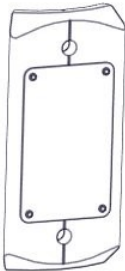
Sign. \_\_\_\_\_.

Adventure Lifjell, Grå-grønn 14-101-012	Navn	Artnr/ dimensjon	Ant	Lev
	Brannstang gulv 1,9m komplett L=3000 Grå	07-200-037K (Se egen del- montering)	1	
	Sluse komplett H=790 Grønn	07-500-074K (Se egen del- montering)	2	
	Produktmerke	07-500-500	1	
	Endelokk 110	00-400-995	3	

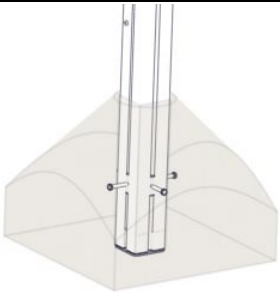
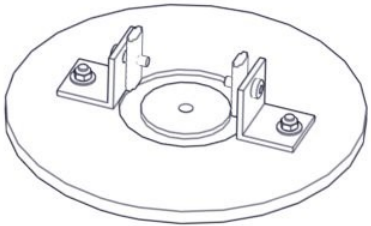
<b>Boltepakker for / Boltpackage for / Bultpaket för</b>		Sign. _____.		
Adventure Lifjell, Grå-grønn 14-101-012	Navn	Artnr/ dimensjon	Ant	Lev
	<b>Fundament Støp</b>			
	Støpefundament stolpe Ø110	00-003-111K (se egen del- montering)	3	
	<b>Fundament Nedgravning</b>			
	Fundamentplate 1x110 stolpe Komplett	07-400-101K (se egen del- montering)	3	

<b>Boltepakker for / Boltpackage for / Bultpaket för</b>		Sign. _____.		
Adventure Lifjell, Grå-grønn 14-101-012	Navn	Artnr/ dimensjon	Ant	Lev
	<b>Overflatemon- tering</b>			
	Fundament 3x110 stolpe for betongdekke	00-003-115K (Se egen del- montering)	1	
	Stolpe Ø110 må kappes Slider må kappes Edderkoppnett dobbel må kap- pes Brannstang må kappes	SFA5126/2 07-200-010 07-500-028 07-200-037		



**Revisjon:**

17.08.2020\_MTF

Oppdatert div view

Oppdatert bilder for Areal, sikkerhetszone og stolpeplassering

Oppdatert fundamentbilder

Oppdatert BOM

18.08.2020\_MTF

Oppdatert div view

Lagt til tabell og oppdatert mål/vekt/betong

Oppdatert art. nr. for stolper i plukklister

24-11-2021 SV

Endret sikkerhetszone pga slider

MTK

02-03-2022

I tillegg overflatemontering